

# Electric Air Compressor



**Operating Instructions**  
(Original Instructions)

**Betriebsanleitung**  
(Übersetzung Der  
Ursprünglichen Anweisungen)

**Gebruiksaanwijzing**  
(Vertaling Van De  
Oorspronkelijke Gebruiksaanwijzing)

**Kayttoohjeet**  
(Alkuperäisten Ohjeiden Käännös)

**Brukvisning**  
(Oversettelse Av De  
Originale Instruksjonene)

**Brukvisning**  
(Översättning Av De  
Ursprungliga Undervisningarna)

**Betjeningsvejledning**  
(Oversættelse Af De Originale Instruktioer)

**Mode D'emploi**  
(Traduction Des Instructions Originales)

**Instrucciones De Empleo**  
(La Traducción De Las Instrucciones Originales)

**Istruzione Per L'uso**  
(Traduzione Delle Istruzioni Originali)

# SENCO®

Senco Brands, Inc.  
4270 Ivy Pointe Blvd.  
Cincinnati, OH 45245  
1-800-543-4596  
www.senco.com  
EMEA: www.senco-emea.com



Warnings for the safe use of this compressor are included in this manual.



Read and understand this manual.

## Table Of Contents

Introduction.....	3
Inspection .....	3
Safety Warnings.....	4
Compressor Features .....	8
Preparation.....	10
Initial Set-Up .....	10
Location .....	10
Electrical .....	10
Operation.....	11
Pre-Start Checklist.....	11
Start-Up .....	11
Shutdown .....	11
Maintenance.....	11
Troubleshooting .....	12
Compressor Specifications .....	14
Declaration of Conformity.....	14
Limited Warranty .....	15
Parts Reference Guide.....	16

## Introduction

Congratulations on the purchase of your new SENCO® Air Compressor! You can be assured your SENCO Air Compressor was constructed with the highest level of precision and accuracy. Each component has been rigorously tested by technicians to ensure the quality, endurance and performance of this air compressor.

This operator's manual was compiled for your benefit. By reading and following the simple safety, installation and operation, and maintenance steps described in this manual, you will receive years of troublefree operation from your new SENCO Air Compressor. The contents of this manual are based on the latest product information available at the time of publication. The manufacturer reserves the right to make changes in price, color, materials equipment, specifications or models at any time without notice.



### Safety Alert!

A “DANGER, WARNING or CAUTION” safety warning will be surrounded by a “SAFETY ALERT BOX.” This box is used to designate and emphasize Safety Warnings that must be followed when operating this air compressor. Accompanying the safety warnings are “Signal Words” which designate the degree or level of hazard seriousness. The “Signal Words” used in this manual are as follows:

**DANGER:** Indicates an imminently hazardous situation which, if not avoided, WILL result in death or serious injury.

**WARNING:** Indicates an imminently hazardous situation which, if not avoided, COULD result in death or serious injury.

**CAUTION:** Indicates an imminently hazardous situation which, if not avoided MAY result in minor or moderate injury or damage to the air compressor.



The symbols set to the left of this paragraph are “Safety Alert Symbols.” These symbols are used to call attention to items or procedures that could be dangerous to you or other persons using this equipment.

**ALWAYS PROVIDE A COPY OF THIS MANUAL TO ANYONE USING THIS EQUIPMENT. READ ALL INSTRUCTIONS IN THIS MANUAL AND ANY INSTRUCTIONS SUPPLIED BY MANUFACTURERS OF SUPPORTING EQUIPMENT BEFORE OPERATING THIS AIR COMPRESSOR AND ESPECIALLY POINT OUT THE “SAFETY WARNINGS” TO PREVENT THE POSSIBILITY OF PERSONAL INJURY TO THE OPERATOR.**

## Inspection

Unbox the air compressor and write in the serial number in the space provided below. Inspect for signs of obvious or concealed freight damage. Be sure that all damaged parts are replaced and any mechanical problems are corrected prior to the operation of the air compressor.

**SERIAL NUMBER** \_\_\_\_\_

If you have Questions or Comments call SENCO's toll-free Action-line: **1-800-543-4596** or, e-mail: [toolprof@Senco.com](mailto:toolprof@Senco.com)

Please have the following information available for all service calls:



1. Model Number
2. Serial Number
3. Date and Place of Purchase

Senco, 4270 Ivy Pointe Blvd., Cincinnati, OH 45245

## Safety Warnings





### Read All Safety Warnings Before Using Air Compressor

Hazard	Potential Consequence	Prevention
<p style="text-align: center;"><b>Risk of Electric Shock or Electrocution</b></p> <div style="text-align: center;">      </div>	<ul style="list-style-type: none"> <li>• Serious injury or death could occur if the air compressor is not properly grounded. Your air compressor is powered by electricity and may cause electric shock or electrocution if not used properly.</li> </ul>	<ul style="list-style-type: none"> <li>• Make sure the air compressor is plugged into a properly grounded outlet which provides correct voltage and adequate fuse protection.</li> </ul>
	<ul style="list-style-type: none"> <li>• Electrical shock may occur from electrical cord.</li> </ul>	<ul style="list-style-type: none"> <li>• Check power cord for signs of crushing, cutting or heat damage. Replace faulty cord before use.</li> <li>• Keep all connections dry and off the ground. Do not allow electrical cords to lay in water or in such a position where water could come in contact with them. Do not touch plug with wet hands.</li> <li>• Do not pull on the electrical cord to disconnect from the outlet.</li> </ul>
	<ul style="list-style-type: none"> <li>• Electrical shock may occur if air compressor is not operated properly.</li> </ul>	<ul style="list-style-type: none"> <li>• Never operate air compressor in wet conditions or outdoors when it is raining.</li> <li>• Never operate air compressor with safety guards/covers removed or damaged.</li> </ul>
	<ul style="list-style-type: none"> <li>• Serious injury or death may occur if electrical repairs are attempted by unqualified persons.</li> </ul>	<ul style="list-style-type: none"> <li>• Any electrical wiring or repairs performed on this air compressor should be done by Authorized Service Personnel in accordance with National and Local electrical codes.</li> <li>• Before opening any electrical enclosure, always shut off the air compressor, relieve pressure and unplug the air compressor from the power source. Allow air compressor to cool down. Never assume the air compressor is safe to work on just because it is not operating. It could restart at any time!</li> </ul>

## Safety Warnings





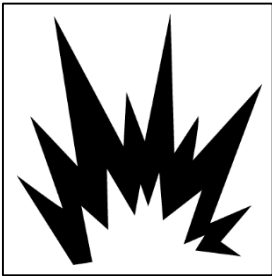

### Read All Safety Warnings Before Using Air Compressor

Hazard	Potential Consequence	Prevention
<p style="text-align: center;"><b>Risk of Explosion or Fire</b></p> <div style="text-align: center;">    </div>	<ul style="list-style-type: none"> <li>• Serious injury or death may occur from normal electrical sparks in motor and pressure switch.</li>   <li>• Serious injury may occur if any air compressor ventilation openings are restricted, causing the air compressor to overheat and start on fire.</li> </ul>	<ul style="list-style-type: none"> <li>• Always operate air compressor in a well ventilated area free of flammable vapors, combustible dust, gases or other combustible materials.</li> <li>• If spraying flammable material, locate the air compressor at least 6 meters away from the spray area. (An additional hose may be required.)</li>   <li>• Never place objects against or on top of air compressor. Operate air compressor at least 30 cm away from any wall or obstruction that would restrict proper ventilation.</li> </ul>
<p style="text-align: center;"><b>Risk of Bursting</b></p> <div style="text-align: center;">  </div>	<ul style="list-style-type: none"> <li>• Serious injury or death may occur from an air tank explosion if air tanks are not properly maintained.</li>   <li>• Serious injury may occur from an air compressor malfunction or exploding accessories if incorrect system components, attachments or accessories are used.</li> </ul>	<ul style="list-style-type: none"> <li>• Drain air tank daily or after each use to prevent moisture buildup in the air tank.</li> <li>• If air tank develops a leak, replace the air tank immediately. Never repair, weld or make modifications to the air tank or its attachments.</li> <li>• Never make adjustments to the factory set pressures.</li>   <li>• Never exceed manufacturer's maximum allowable pressure rating of attachments.</li> <li>• Because of extreme heat, do not use plastic pipe or lead tin soldered joints for a discharge line.</li> <li>• Never use air compressor to inflate small, low pressure objects such as toys.</li> <li>• All hoses and fittings shall be suitable for site use at the maximum allowable working pressure of the portable compressor.</li> <li>• Use only genuine SENCO® repair parts for your air compressor.</li> </ul>

## Safety Warnings

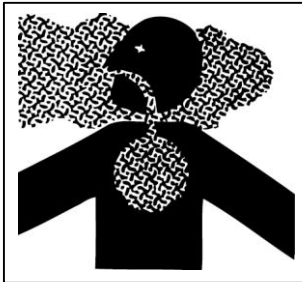



### Read All Safety Warnings Before Using Air Compressor

Hazard	Potential Consequence	Prevention
<p style="text-align: center;"><b>Risk to Breathing</b></p> 	<ul style="list-style-type: none"> <li>• Serious injury or death could occur from inhaling compressed air. The air stream may contain carbon monoxide, toxic vapors or solid particles.</li> <li>• Sprayed materials such as paint, paint solvents, paint remover, insecticides, weed killers, etc. contain harmful vapors and poisons.</li> </ul>	<ul style="list-style-type: none"> <li>• Never inhale air from the air compressor either directly or from a breathing device connected to the air compressor.</li> <li>• Operate air compressor only in a well ventilated area. Follow all safety instructions provided with the materials you are spraying. Use of a respirator may be required when working with some materials.</li> </ul>
<p style="text-align: center;"><b>Risk of Burns</b></p> 	<ul style="list-style-type: none"> <li>• Serious injury could occur from touching exposed metal parts. These areas can remain hot for some time after the air compressor is shut down.</li> </ul>	<ul style="list-style-type: none"> <li>• Never allow any part of your body or other materials to make contact with any exposed metal parts on the air compressor, motor, or pipework.</li> </ul>
<p style="text-align: center;"><b>Risk of Flying Objects</b></p> 	<ul style="list-style-type: none"> <li>• Soft tissue damage can occur from the compressed air stream.</li> </ul>	<ul style="list-style-type: none"> <li>• Always wear OSHA required "Z87" safety glasses to shield the eyes from flying debris.</li> <li>• Never point the air stream at any part of your body, anyone else or animals.</li> <li>• Never leave pressurized air compressor unattended. Shut off air compressor and relieve pressure before attempting maintenance, attaching tools or accessories.</li> </ul>
<p style="text-align: center;"><b>Eye Protection Must Be Worn</b></p> 	<ul style="list-style-type: none"> <li>• Serious injury can occur from loose debris being propelled at a high speed from the compressed air stream.</li> </ul>	<ul style="list-style-type: none"> <li>• Always maintain a safe distance from people and animals while operating the air compressor.</li> <li>• Do not move the air compressor while air tank is under pressure. Do not attempt to move the air compressor by pulling on the hose.</li> </ul>

## Safety Warnings



### Read All Safety Warnings Before Using Air Compressor

Hazard	Potential Consequence	Prevention
<p><b>Risk from Moving Parts</b></p>  <p><b>Warning: Unit May Start Without Warning</b></p> 	<ul style="list-style-type: none"> <li>• Risk of bodily injury from moving parts. This air compressor cycles automatically when the pressure switch is in the <b>ON (1)</b>/Auto position.</li> </ul>	<ul style="list-style-type: none"> <li>• Always turn off air compressor when not in use. Bleed pressure from the air hose and unplug from electrical outlet before performing maintenance. All repairs to the air compressor should be made by an Authorized Service person. Never assume the air compressor is safe to work on just because it is not operating. It could restart at any time!</li> </ul>
<p><b>Risk from Negligence</b></p> 	<ul style="list-style-type: none"> <li>• Risk of injury from negligent use.</li> </ul>	<ul style="list-style-type: none"> <li>• Do not operate without protective covers/guards. Replace damaged covers/guards before using the air compressor.</li> <li>• Never allow children or adolescents to operate this air compressor!</li> <li>• Stay alert -- watch what you are doing. Do not operate the air compressor when fatigued or under the influence of alcohol or drugs.</li> <li>• Know how to stop the air compressor. Be thoroughly familiar with controls.</li> </ul>
<p><b>Risk of Air Compressor Damage</b></p>	<ul style="list-style-type: none"> <li>• Risk of major repair.</li> </ul>	<ul style="list-style-type: none"> <li>• Do not operate air compressor without an air filter.</li> <li>• Do not operate air compressor in a corrosive environment.</li> <li>• Do not incline the air compressor transversely or longitudinally more than 10°.</li> <li>• Always operate the air compressor in a stable, secure position to prevent air compressor from falling.</li> <li>• Follow all maintenance instructions listed in this manual.</li> </ul>

**! SAVE THESE INSTRUCTIONS !**

## Compressor Features

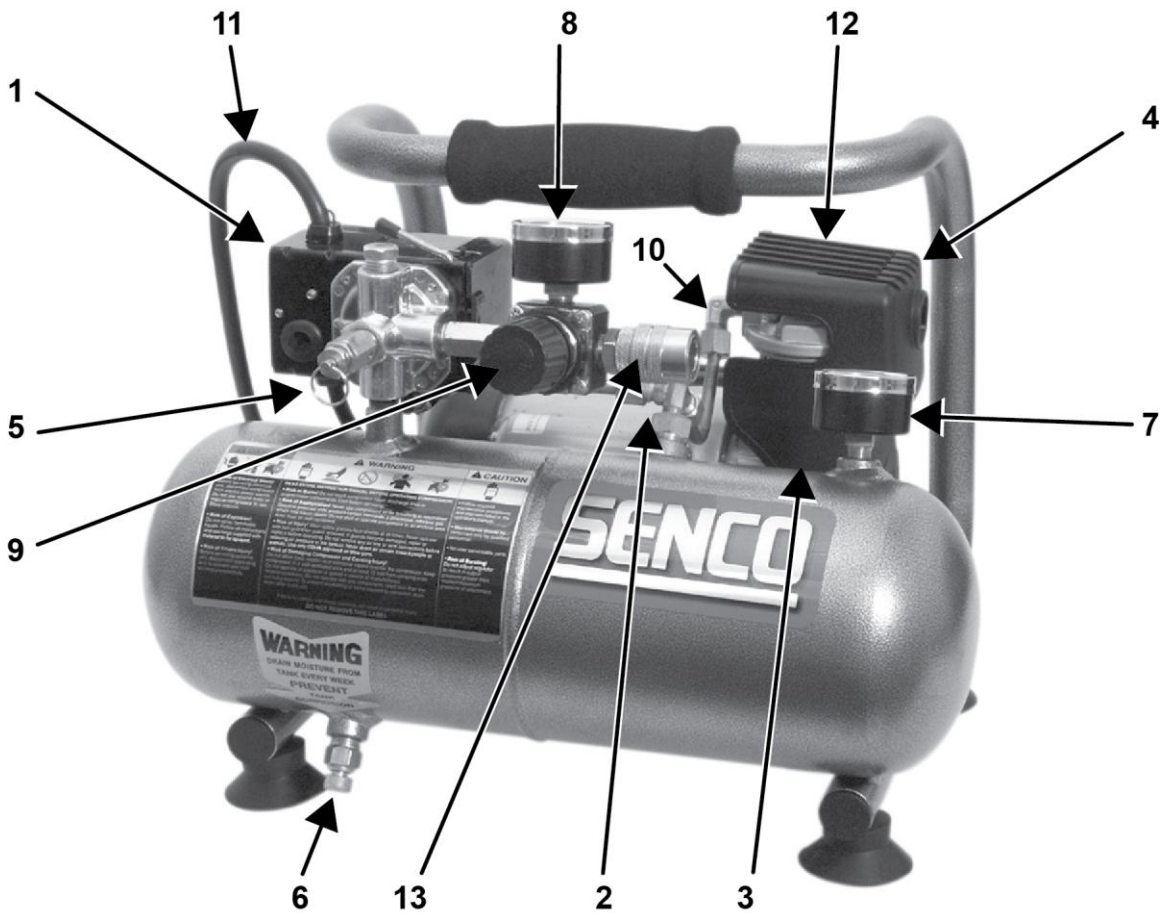

1.	Motor/Pressure Switch
2.	Thermal Overload / Reset
3.	Air Intake Filter
4.	Air Compressor Pump
5.	Safety Relief Valve
6.	Air Tank Drain Valve
7.	Tank Pressure Gauge
8.	Outlet Pressure Gauge
9.	Pressure Regulator
10.	Discharge Line
11.	Electric Power Cord
12.	Ventilation Openings / Protective Shroud
13.	Quick Disconnect



## Compressor Features

**1) Motor/Pressure Switch:** This switch is used to start or stop the air compressor. Moving the switch to the **ON (1)** position will provide automatic power to the pressure switch which will allow the motor to start when the air tank pressure is below the factory set cut-in pressure. When in the **ON (1)** position, the pressure switch stops the motor when the air tank pressure reaches the factory set cut-out pressure. For safety purposes, this switch also has a pressure release valve located on the side of the switch designed to automatically release compressed air from the air compressor pump head and its discharge line when the air compressor reaches cut-out pressure or is shut off. This allows the motor to restart freely. Moving the switch to the **OFF (0)** position will remove power from the pressure switch and stop the air compressor.

**2) Motor Thermal Overload:** Motor has a protective breaker located on the pump. Excessive amperage draw will result in the breaker tripping to protect the motor and operator. Reset the breaker by pushing the black plastic stem back into the housing. Reset switch if it is tripped.

**3) Air Intake Filter:** This filter is designed to clean air coming into the pump. To ensure the pump continually receives a clean, cool, dry air supply, this filter must always be clean and ventilation opening free from obstructions. The filter can be removed for cleaning by using warm, soapy water. Rinse the filter and air dry.

**4) Air Compressor Pump:** To compress air, the piston moves up and down in the cylinder. On the downstroke, air is drawn in through the air intake valve while the exhaust valve remains closed. On the upstroke, air is compressed, the intake valve closes and compressed air is forced out through the exhaust valve, into the discharge line, through the check valve and into the air tank.

**5) Safety Relief Valve:** This valve is designed to prevent system failures by relieving pressure from the system when the compressed air reaches a predetermined level. The valve is preset by the manufacturer and must not be modified in any way. To verify the valve is working properly, pull on the ring. Air pressure should escape. When the ring is released, it will reset.

**6) Air Tank Drain Valve:** The drain valve is used to remove moisture from the air tank(s) after the air compressor is shut off. **NEVER attempt to open the drain valve when more than 0.7 bar of air pressure is in the air tank!** To open the drain valve, turn the knob counter-clockwise. Tilt tank to ensure that all condensation drains through valve.

**7) Air Tank Pressure Gauge:** The air tank pressure gauge indicates the reserve air pressure in the air tank(s).

**8) Outlet Pressure Gauge:** The outlet pressure gauge indicates the air pressure available at the outlet side of the regulator. This pressure is controlled by the regulator and is always less or equal to the air tank pressure.

**9) Pressure Regulator:** The air pressure coming from the air tank is controlled by the regulator knob. Turn the pressure regulation knob clockwise to increase discharge pressure, and counter-clockwise to decrease discharge pressure. Follow tool operating instructions for recommended pressure range.

**10) Discharge Line:** Please note that the discharge line is very hot. **HOT SURFACES: Do not remove protective shroud. High temperature after sustained use.**

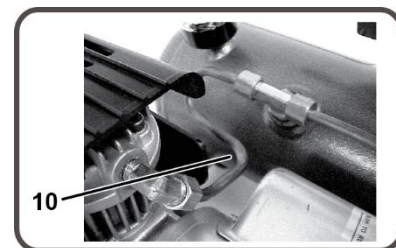
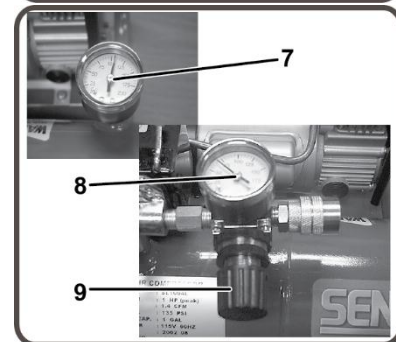
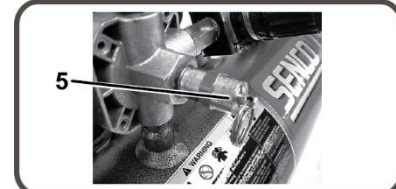
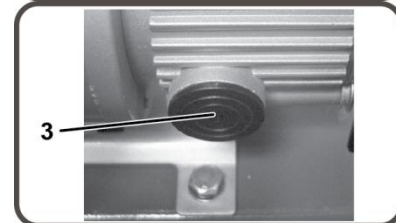
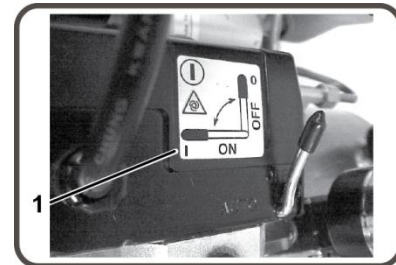

## Preparation

### Initial Set-Up

1. Read safety warnings before setting-up air compressor.

### Location

**Caution** In order to avoid damaging the air compressor, do not incline the air compressor transversely or longitudinally more than 10°.

1. Place air compressor at least 30 cm away from obstacles that may prevent proper ventilation.

Do not place air compressor in an area:

- Where there is evidence of oil or gas leaks.
- Where flammable gas vapors or materials may be present.

**Warning**



Serious injury or death may occur if electrical sparks from motor and pressure switch come in contact with flammable vapors, combustible dust, gases or other combustible materials. When using the air compressor for spray painting, place the air compressor as far away from the work area as possible, using extra air hoses instead of extension cords.

- Where air temperatures fall below 0°C or exceed 40°C.
- Where extremely dirty air or water could be drawn into the air compressor.

### Electrical

**Danger**



Improper connection of the equipment-grounding conductor can result in a risk of shock or electrocution. Check with a qualified electrician or service personnel if you are in doubt as to whether the outlet is properly grounded. Do not use any type of adapter with this product. If repair or replacement of the cord or plug is necessary, do not connect the grounding wire to either flat blade terminal. The wire with insulation having an outer surface that is green with or without yellow stripes is the grounding wire.

**Warning**



This product must be grounded. If there should be a malfunction or breakdown, grounding provides a path of least resistance for electric current to reduce the risk of electric shock. This product is equipped with a cord having an equipment grounding conductor and a grounding type plug. The plug must be plugged into an appropriate outlet that is properly installed and grounded in accordance with all local codes and ordinances.

1. SENCO® DOES NOT RECOMMEND THE USE OF EXTENSION CORDS as this can create power loss and overheating of the motor. Use of an additional air hose is recommended rather than an extension cord. If use of an extension cord is unavoidable, it should be plugged into a GFCI found in circuit boxes or protected receptacles.

When using an extension cord, observe the following:

<u>Cable Length</u>	<u>Wire Gauge</u>
Up to 8 meters	12 AWG
Up to 30 meters	10 AWG
Up to 50 meters	8 AWG
Up to 75 meters	6 AWG

Use only extension cords having an electrical rating not less than the rating of the product. Do not use damaged extension cords. Examine extension cord before using and replace if damaged. Do not abuse extension cord and do not yank on any cord to disconnect. Keep cord away from heat and sharp edges. Always shut off the air compressor switch before removing the plug from the receptacle.

## Operation

### Pre-Start Checklist

1. Remove any moisture in the air compressor tank. Remove excessive pressure by pulling on the safety relief valve ring or with an air tool, then open the air tank drain valve in the bottom of the air tank. Close tightly when drained.

**Warning: Risk of bodily injury. NEVER attempt to open the drain valve when more than 0.7 bar of air pressure is in the air tank!**

2. Make sure the air compressor Motor Switch is in the **OFF (0)** position.
3. Make sure all safety valves are working correctly.
4. Make sure all guards and covers are in place and securely mounted.

### Start-Up

1. Ensure the lever on the pressure switch box is in the **OFF (0)** position.
2. Plug the power cord into the grounded outlet.
3. Move the motor switch to the **ON (1)** position.
4. This will allow the air compressor to **Start** building up pressure in the air tanks and **Stop** when correct pressure is achieved. When pressure drops with usage, the air compressor will **Start** building up pressure again.
5. Set pressure by adjusting the pressure regulator knob counter-clockwise for less pressure and clockwise for more pressure.
6. If you notice any unusual noise or vibration, stop the air compressor and refer to "Troubleshooting."

### Shutdown

1. To stop the air compressor, move the lever on the motor switch to the **OFF (0)** position. NEVER stop the air compressor by unplugging it from the power source. This could result in risk of electrocution.
2. Drain air from the air tank by releasing air with an attached air tool or by pulling on the safety relief valve ring.
3. Once pressure in the air tanks register under 0.7 bar, open the drain valve under each air tank to drain any moisture.
4. Allow the air compressor to cool down.
5. Wipe air compressor clean and store in a safe, non-freezing area.

## Maintenance

Read the instruction manual before performing maintenance. The following procedures must be performed when stopping the air compressor for maintenance or service.

1. Turn off the air compressor.

**Warning: Never assume the air compressor is safe to work on just because it is not operating. It could restart at any time!**

2. Disconnect cord from main power supply.
3. Open all drains.
4. Wait for the air compressor to cool before starting service.

### Maintenance Chart

Procedure	Daily	Weekly	Monthly
Drain condensation in air tank(s)	X		
Check for unusual noise/vibration	X		
Check for air leaks	X		
Inspect air filter		X	
Clean exterior of compressor		X	
Check safety relief valve			X

## Troubleshooting

### Symptom 1. Motor will not run or restart.

Probable Cause	Remedy
<ul style="list-style-type: none"> <li>• Power cord not plugged in.</li> </ul>	<ul style="list-style-type: none"> <li>• Plug cord into grounded outlet.</li> </ul>
<ul style="list-style-type: none"> <li>• Motor/Pressure switch in <b>OFF (0)</b> position.</li> </ul>	<ul style="list-style-type: none"> <li>• Move switch to <b>ON (1)</b> position.</li> </ul>
<ul style="list-style-type: none"> <li>• Motor thermal overload switch has tripped.</li> </ul>	<ul style="list-style-type: none"> <li>• Turn air compressor off, wait until motor is cool, then check motor circuit breaker.</li> </ul>
<ul style="list-style-type: none"> <li>• Fuse blown or circuit breaker has tripped.</li> </ul>	<ul style="list-style-type: none"> <li>• Replace fuse or reset circuit breaker.</li> <li>• Check for proper fuse amperage.</li> <li>• Check for low voltage conditions.</li> <li>• Disconnect any other electrical appliances from circuit or operate air compressor on its own branch circuit.</li> </ul>
<ul style="list-style-type: none"> <li>• Wrong gauge wire or length of extension cord.</li> </ul>	<ul style="list-style-type: none"> <li>• Check chart on page 10 for proper gauge wire and cord length.</li> </ul>
<ul style="list-style-type: none"> <li>• Air tank pressure exceeds motor/pressure switch “cut-in” pressure.</li> </ul>	<ul style="list-style-type: none"> <li>• Motor will start automatically when air tank pressure drops below “cut-in” pressure of motor/pressure switch.</li> </ul>
<ul style="list-style-type: none"> <li>• Pressure release valve on motor/pressure switch has not unloaded pump head pressure.</li> </ul>	<ul style="list-style-type: none"> <li>• Bleed the line by moving the switch to the <b>OFF (0)</b> position.</li> </ul>
<ul style="list-style-type: none"> <li>• Defective motor, motor capacitor, motor/pressure switch, or check valve.</li> </ul>	<ul style="list-style-type: none"> <li>• Contact Senco Customer Service.</li> </ul>

### Symptom 2. When in the **ON (1)** position, motor runs continuously.

Probable Cause	Remedy
<ul style="list-style-type: none"> <li>• Motor/Pressure switch does not shut off motor when air compressor reaches “cut-out” pressure and safety relief valve activates.</li> </ul>	<ul style="list-style-type: none"> <li>• Move the motor/pressure switch to the <b>OFF (0)</b> position. If the motor doesn’t shut off, unplug the air compressor. If the electrical contacts are welded together, replace the pressure switch.</li> </ul>
<ul style="list-style-type: none"> <li>• Air compressor is incorrectly sized.</li> </ul>	<ul style="list-style-type: none"> <li>• Limit the air pressure to the capacity of the air compressor. Either use a smaller tool or a larger air compressor.</li> </ul>

### Symptom 3. Air continues to leak at motor/pressure switch release valve after motor stops.

Probable Cause	Remedy
<ul style="list-style-type: none"> <li>• The check valve is stuck open.</li> </ul>	<ul style="list-style-type: none"> <li>• Remove, clean, or replace.</li> </ul>

### Symptom 4. Air continues to leak at motor/pressure switch release valve after motor is running.

Probable Cause	Remedy
<ul style="list-style-type: none"> <li>• Defective motor/pressure switch.</li> </ul>	<ul style="list-style-type: none"> <li>• Replace.</li> </ul>

### Symptom 5. Air leaks from safety relief valve.

Probable Cause	Remedy
<ul style="list-style-type: none"> <li>• Possible defective safety relief valve.</li> </ul>	<ul style="list-style-type: none"> <li>• Operate safety relief valve manually by pulling on ring. If it still leaks, it should be replaced.</li> </ul>
<ul style="list-style-type: none"> <li>• Excessive air tank pressure.</li> </ul>	<ul style="list-style-type: none"> <li>• Defective motor/pressure switch. Replace.</li> </ul>

## Troubleshooting

### Symptom 6. Air leaks at fittings.

Probable Cause	Remedy
<ul style="list-style-type: none"> <li>Fittings are not tight enough.</li> </ul>	<ul style="list-style-type: none"> <li>Tighten fittings where air can be heard escaping. Check fittings with soapy water solution. <b>Do not overtighten.</b></li> </ul>

### Symptom 7. Air leak in air tank.

Probable Cause	Remedy
<ul style="list-style-type: none"> <li>Defective or rusted air tank.</li> </ul>	<ul style="list-style-type: none"> <li>Air tank must be replaced. <b>Do not attempt to repair air tank!</b> <b>Do not weld, repair or make modifications.</b></li> </ul>

### Symptom 8. Air blowing from inlet filter.

Probable Cause	Remedy
<ul style="list-style-type: none"> <li>Damaged inlet (reed) valve.</li> </ul>	<ul style="list-style-type: none"> <li>Contact SENCO Customer Service.</li> </ul>

### Symptom 9. Insufficient pressure at air tool or accessory.

Probable Cause	Remedy
<ul style="list-style-type: none"> <li>Pressure regulator knob not turned to high enough pressure or defective pressure regulator.</li> </ul>	<ul style="list-style-type: none"> <li>Adjust pressure regulator knob to proper setting or replace.</li> </ul>
<ul style="list-style-type: none"> <li>Restricted air intake filter.</li> </ul>	<ul style="list-style-type: none"> <li>Clean.</li> </ul>
<ul style="list-style-type: none"> <li>Air leaks.</li> </ul>	<ul style="list-style-type: none"> <li>Check for leaks and repair.</li> </ul>
<ul style="list-style-type: none"> <li>Air compressor is not large enough for air requirement.</li> </ul>	<ul style="list-style-type: none"> <li>Check the accessory air requirement. If it is higher than the CFM or pressure supply of the air compressor, you need a larger air compressor.</li> </ul>

### Symptom 10. Air compressor not making enough air.

Probable Cause	Remedy
<ul style="list-style-type: none"> <li>Restricted air intake filter.</li> </ul>	<ul style="list-style-type: none"> <li>Clean.</li> </ul>
<ul style="list-style-type: none"> <li>Defective (reed) valve.</li> </ul>	<ul style="list-style-type: none"> <li>Drain air tank and measure pump up time. Compare to specifications. If lower, remove pump head and inspect valve plate, clean or replace.</li> </ul>

### Symptom 11. Moisture in discharge air.

Probable Cause	Remedy
<ul style="list-style-type: none"> <li>Condensation in air tank caused by high level of atmospheric humidity or air compressor is not run long enough.</li> </ul>	<ul style="list-style-type: none"> <li>Drain air tank after every use. Drain air tank more often in humid weather and use an air line filter.</li> </ul>

## Compressor Specifications

Model #: PC 1010		
<b>Motor</b>	Horsepower	0.5 HP (peak) / 0.3 HP (Running)
	Voltage	230V
	Amperage	2A
	Hz.	50
	Phase	Single
	RPM	2850
<b>Compressor Pump</b>	Number of Cylinders	1
	Compression Stage	1
	Crankcase	Aluminum
	Bearings	Ball
	Cylinder	Aluminum
	Valves	Reed-Single
	Head	Aluminum
	Filter	Insert
<b>Motor/Pressure Switch Setting</b>	Cut-out	8.6 bar (125 PSI)
	Cut-in	6.6 bar (95 PSI)
	Controls	ON (1) / OFF (0)
<b>Air Tank</b>	Capacity	3.8 Liter(1 Gallon)
<b>Performance</b>	L/Min Air Displacement	32 (1.1 CFM)
	L/Min @ 2.8 bar	17 (0.6 CFM @ 40 PSI)
	L/Min @ 6.2 bar	10 (0.35 CFM @ 90 PSI)
	L/Min @ 6.9 bar	9 (0.31 CFM @ 100 PSI)
	Maximum Pressure	8.6 bar (125 PSIG)
	Pump-up Time: 0-9 bar	160 seconds
	Recovery Time: 7-9 bar	48 seconds
<b>Weight</b>	Net	9.1 kg
<b>Dimensions</b>	Basic LxWxH	36 x 33 x 25 cm
<b>Noise</b>	Measured sound power level (dB)	78 dBA
	Guaranteed sound power level (dB)	81 dBA

## Declaration of Conformity

We Senco Brands, Inc.  
of 4270 Ivy Pointe Blvd., Cincinnati, Ohio 45245  
in accordance with the following directive(s):  
**Machine Directive 2006/42/EC**  
**Pressure Vessel Directive 2009/105/EC.**  
**EMC Directive 2004/108/EC**  
**Low Voltage Directive 2006/95/EC**  
**RoHS Directive 2011/65/EU**  
**Noise Emission Directive 2005/88/EC**  
declare under our sole responsibility that Model(s):  
**PC 1010 EU, PC 1010EU-2P, PC 1010EUS, PC 1010EUS-UK110,**  
**PC 1010PL, PC 1010S, PC 1010UK1, PC 1010UK2**  
is in conformity with the applicable essential health and safety requirements of  
the following documents:  
**EN ISO 14121-1:2007, EN ISO 3744:1995, EN ISO 4871:2009,**  
**EN1012-1:2010, EN 60204-1:2006+A1:2009, EN286-1:1998**  
Signed by: Chris Klein  
Position: Director of Engineering  
Place of DOC: Senco Brands, Inc.  
4270 Ivy Pointe Blvd., Cincinnati, Ohio 45245  
On Date: September 4, 2014  
Authorized Representative:  
  
Name: Peter van der Wel  
Address: Senco Brands B.V.  
Geurdeland 17E, 6673 DR Andelst, The Netherlands

**1. Senco Professional End User Warranty Policy**

Considering the following constraints Senco underwrites the reliability and the quality of its supplied authorised Senco branded products.

1.1 Senco warrants to the end user that the following products will be free from defects in construction, assembly and material for the warranty period specified below.

Product	Warranty period
Senco ® XP Series-Red Cap, pneumatic tools	Five years
Senco ® XP Series-Black Cap, pneumatic tools	Two years
Senco Pro Series, pneumatic tools	One year
Senco Semi-Pro Series, pneumatic tools	One year
Senco DuraSpin ® Series, electric and battery tools	One year
Senco Cordless battery tools	Two years
Senco batteries and chargers for tools	One year
Senco gas tools	Two years
Senco Reconditioned Products	One year
Senco other tools	One year
Senco Compressors	One year

1.2 The warranty period starts on the day the end user purchases the product and/or 1 year after the tool has been deleted from the product line, which ever date comes first.

1.3 To claim warranty the end user needs to send the defective products or their parts, including the serial number and the original and dated sales receipt or proof of purchase from the original retailer or dealer, freight prepaid to the original retailer or dealer.

1.4 Senco is not obliged to do any repairs or replacements on any products or their parts on site.

1.5 During the warranty period Senco or its distributors will repair or replace defective products or their parts, exclusively or mainly as a result of an imperfection in construction, assembly or material, at Senco's option and expense, subject to the constraints of this warranty policy.

1.6 The repair or replacement of products or their parts under warranty, does in no case lead to prolongation of the warranty period. For every replacement product or part, the remaining original warranty period of the replaced product or part is applicable.

1.7 Senco will become the owner of the products or parts that have been replaced by Senco or its distributors as a result of being compliant to Senco's warranty, without being obligated any compensation in this matter.

1.8 Excluded from the warranty are:

- Normal wear and tear parts, for example rubber o-rings, seals, driver blades, piston stops, piston/driver assemblies, isolators, drive belts, air filters and fuel systems, bits;
- Any imperfection that is a result of or has evolved from the fact that there has not been used clean, dry regulated compressed air and/or the air pressure applied has exceeded the maximum indicated on the tool casting (pneumatic tools);
- Any imperfection that is a result of or has evolved from normal wear, misapplication, abuse/misuse, improper modifications or storage, shipping/transport, accidents, neglect, operation at other than recommended speeds or voltage (electric units only);
- Any imperfection that is a result of or has evolved from explosions, fires and natural disasters, like hurricanes, floods and earthquakes;
- Any imperfection that is a result of or has evolved from not following operating instructions, specifications and / or maintenance schedules. Read the Operator Manual for use, specifications and maintenance instructions;
- Any imperfection that is caused by repairs, modifications to the product or attempts to do so by the end user or any third party;
- Labour charges or loss or damage resulting from improper operation, maintenance or repairs are not covered by this warranty
- Any warranty claims that have been received after the warranty period, as specified in this end user warranty, has expired.

1.9 Additional costs like shipping/transport, special packaging requirements and costs of travel and accommodation, are at the end users expense.

1.10 If a complaint is unfounded, all costs incurred thereby, including handling, inspection, shipping and administrative costs on the side of Senco or its distributors, will be charged to the end user.

1.11 After expiration of the warranty period, all costs for repair or replacement, including handling, inspection, shipping and administrative costs will be charged to the end user.

1.12 Notwithstanding legal limitation periods, the limitation of all claims and appeals against Senco and third parties involved by Senco for the implementation of the agreement is one year.

1.13 If Senco fails to meet this agreement, it will not discharge the end user from the obligations arising under this or any other contract.

1.14 When the warranty terms can not be met, due to for example import or export prohibitions, strikes or other unforeseen circumstances, the warranty period will be extended accordingly.

1.15 Senco's liability is limited to the warranty. Senco is not liable for damage caused by the functioning or non-functioning of the products as delivered, repaired or modified by Senco or its distributors, including but not limited to, production losses, profit losses, reduced working range, commercial losses or consequential damages or indirect damages whatsoever.

## 1/2 HP Electric Air Compressor

### Parts Reference Guide

NO:RLB-1409

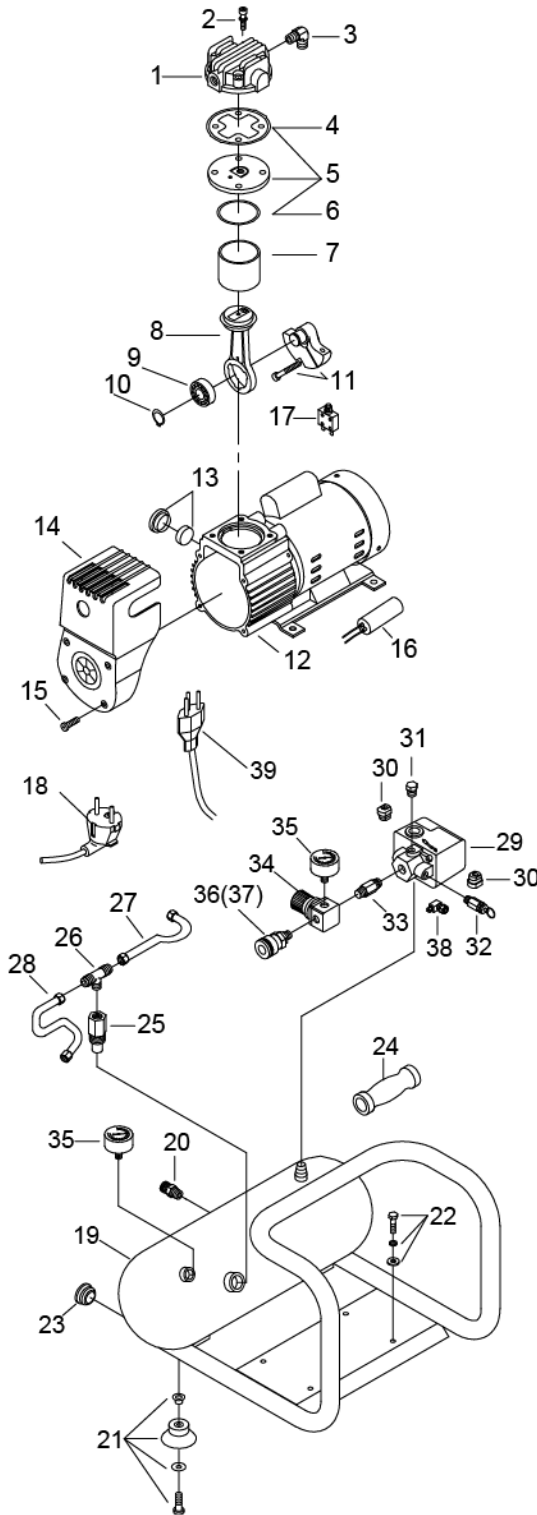

Ref. No.	Description	Part No.	Qty.
1	CYLINDER HEAD	3101063A	1
2	ALLEN BOLT SET	3B01-M05*060V	4
3	EXHAUST ELBOW	2N06-01T02H	1
4	CYLINDER HEAD GASKET	2G01-025H	1
5	EXHAUST VALVE ASSEMBLY	3B11-DC02A	1
6	VALVE SEAT GASKET	2G03-018	1
7	CYLINDER	3201068	1
8	ROD ASSEMBLY	3B3-MB02	1
9	BEARING	2N35-6201ZZC3	1
10	CLIP	2N42-S12	1
11	CRANKSHAFT & BALANCER	3304086	1
12	MOTOR SET	3B8-MB0206S	1
13	AIR FILTER SET	2140026RS	1
14	SHROUD	2428015RS	1
15	BOLT	2B02-FM4*015B	4
16	RUNNING CAPACITOR	2E27-004F4525	1
17	CIRCUIT BREAKER	2E25-01AS	1
18	POWER CABLE (2 PIN)	2E01-029S	1
19	AIR TANK	3401174U	1
20	DRAIN VALVE	2405012	1
21	RUBBER PAD SET	3433011-ARS	4
22	HEXAGON BOLT SET	3B00-FM06*012RS	4
23	PLUG	2N32-W07RS	2
24	GRIP	2432107	1
25	CHECK VALVE	2414033A	1
26	UNLOADING 3-WAY PIPE	2N09-02H01T02H4	1
27	UNLOADING TUBE	3B2-02*190F	1
28	DISCHARGE TUBE	2T02-02*0260RS	1
29	PRESSURE SWITCH	2E21-AA256BPS	1
30	STRAIN RELIEF BUSHING	2E04-008	2
31	PLUG	2N33-009	1
32	PRESSURE RELIEF VALVE	2406021A	1
33	NIPPLE	2N01-058RS	1
34	REGULATOR	2408008RRS	1
35	PRESSURE GAUGE	2D12-15D14BAR	2
36	QUICK COUPLER (FOR PC1010EU ONLY)	07S1/4M-ERS	1
37	QUICK COUPLER (FOR PC1010EU COMBO KIT, PC1010S, 6PR2001N)	07OS1/4M-C	1
38	UNLOADING VALVE	2409015	1
39	POWER CABLE (3 PIN)	2E01-044S	1



# Elektrischer Luftkompressor

## Betriebsanleitung

(Übersetzung Der  
Ursprünglichen Anweisungen)



# SENCO®

Senco Brands, Inc.  
4270 Ivy Pointe Blvd.  
Cincinnati, OH 45245  
1-800-543-4596  
www.senco.com  
EMEA: www.senco-emea.com



Das vorliegende Handbuch enthält Warnungen in Bezug auf die sichere Bedienung dieses Luftkompressors.



Alle Anweisungen lesen und verstehen.

PC1010 • Überarbeitet 11 März 2015 (Ersetzt 1/24/2013)

## Inhalt

Einleitung.....	3
Inspektion .....	3
Sicherheitshinweise .....	4
Leistungsmerkmale des Kompressors.....	8
Vorbereitung.....	10
Einrichten Für Die Erstmalige Inbetriebnahme.....	10
Aufstellort.....	10
Elektrik .....	10
Betrieb .....	11
Checkliste Für Vorbereitung Auf Die Inbetriebnahme .....	11
Inbetriebnahme.....	11
Ausschalten .....	11
Wartung.....	11
Störungsbeseitigung .....	12
Technische Daten .....	14
Konformitätserklärung .....	14
Begrenzte Garantie .....	15
Teile Referenzhandbuch .....	16

## Einleitung

Wir beglückwünschen Sie zum Kauf Ihres neuen SENCO®-Luftkompressors! Sie können sich sicher sein, dass Ihr SENCO-Luftkompressor mit höchster Präzision gebaut wurde. Jede Komponente wurde streng von Technikern geprüft, um Qualität, Haltbarkeit und Leistung dieses Luftkompressors sicherzustellen. Diese Bedienungsanleitung soll Ihnen beim Betrieb helfen. Wenn Sie dieses Handbuch durchlesen und die in ihm enthaltenen einfachen Sicherheits-, Montage- und Bedienungsanweisungen sowie Wartungsschritte beachten, wird Ihr neuer SENCO-Luftkompressor jahrelang störungsfrei funktionieren. Der Inhalt dieses Handbuchs basiert auf den neusten Produktinformationen, die zum Zeitpunkt der Veröffentlichung vorlagen. Der Hersteller behält sich das Recht vor, Preis, Farbe, Werkstoffe, Ausstattung, Spezifikationen oder Modelle jederzeit ohne Vorankündigung zu ändern.



### Sicherheitshinweis!

Jeder Sicherheitshinweis des Typs "GEFAHR", "WARNUNG" oder ACHTUNG" ist mit einem "SICHERHEITSHWEIS-KASTEN" umrandet.

Dieser Kasten dient dazu, Sicherheitshinweise zu markieren und hervorzuheben, die beim Betrieb des Luftkompressors zu beachten sind. Vor den Sicherheitshinweisen finden Sie "Signalwörter", die den Grad bzw. die Größenordnung der Gefahr bezeichnen. Die in diesem Handbuch verwendeten "Signalwörter" lauten wie folgt:

**GEFAHR:** Bezeichnet eine unmittelbar gefährliche Situation, die – falls sie nicht vermieden wird tödlich oder mit Personenschäden enden wird.

**WARNUNG:** Bezeichnet eine potenziell gefährliche Situation, die – falls sie nicht vermieden wird – tödlich oder mit Personenschäden enden könnte.

**ACHTUNG:** Bezeichnet eine potenziell gefährliche Situation, die – falls sie nicht vermieden wird – mit geringfügigen oder minderschweren Personenschäden oder der Beschädigung des Luftkompressors enden könnte.

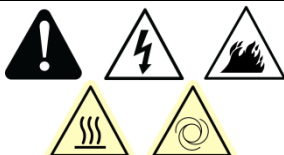

Die Symbole links neben diesem Abschnitt sind so genannte "Sicherheitshinweis-Symbole."

Diese Symbole dienen dazu, auf bestimmte Punkte oder Prozeduren aufmerksam zu machen, die für Sie oder Personen, die dieses Gerät benutzen, gefährlich sein könnten.

**STELLEN SIE JEDER PERSON, DIE DIESES GERÄT BENUTZT, EINE KOPIE DIESES HANDBUCHS ZUR VERFÜGUNG. LESEN SIE ALLE IN DIESEM HANDBUCH ENTHALTENEN ANWEISUNGEN UND SONSTIGEN VON DER HERSTELLER DER ZUBEHÖRTEILE MITGELIEFERTEN ANWEISUNGEN DURCH, EHE SIE DIESEN LUFTKOMPRESSOR BEDIENEN, UND HEBEN SIE BESONDERS DIE "SICHERHEITSHINWEISE" HERVOR, UM DIE GEFAHR ZU VERMEIDEN, DASS SICH DER BEDIENER VERLETZT.**

## Inspektion

Nehmen Sie den Luftkompressor aus der Transportkiste und notieren Sie seine Seriennummer in der unten dafür vorgesehenen Rubrik. Inspizieren Sie den Luftkompressor auf Anzeichen für sichtbare oder verdeckte Transportschäden. Stellen Sie sicher, dass alle beschädigten Teile ausgetauscht und alle mechanischen Probleme behoben werden, bevor Sie den Luftkompressor in Betrieb nehmen.

**Seriennummer** \_\_\_\_\_

Wenn Sie Fragen haben oder Hinweise geben möchten, dann können Sie SENCO gebührenfrei unter folgender Tel.-Nr. anrufen: **1-800-543-4596** oder E-Mail: [toolprof@Senco.com](mailto:toolprof@Senco.com)

Bitte halten Sie bei Service-Anrufen folgende Informationen bereit:



1. Nummer des Modells
2. Seriennummer
3. Datum und Ort des Kaufs

Senco, 4270 Ivy Pointe Blvd., Cincinnati, OH 45245

## Sicherheitshinweise





**Lesen sie alle sicherheitshinweise durch, bevor sie den kompressor betreiben**

Gefahr	Potenzielle Folgen	Unfallverhütung
<p style="text-align: center;"><b>Gefahr Durch Elektrische Schläge oder Tödliche Elektroschocks</b></p> <div style="text-align: center;">      </div>	<ul style="list-style-type: none"> <li>• Wenn der Luftkompressor nicht ordnungsgemäß geerdet wird, kann dies Verletzungen, eventuell mit Todesfolge, nach sich ziehen. Der Luftkompressor wird elektrisch betrieben und kann Quelle elektrischer Schläge oder sogar tödlicher Elektroschocks sein, wenn er nicht ordnungsgemäß betrieben wird.</li> </ul>	<ul style="list-style-type: none"> <li>• Stellen Sie sicher, dass der Luftkompressor an eine ordnungsgemäß geerdete Netzsteckdose angeschlossen wird, die die richtige Spannung führt und angemessen durch eine Sicherung gesichert ist.</li> <li>• Prüfen Sie das Netzkabel auf Anzeichen für Beschädigung durch Quetschung, Schnitte oder Wärme.</li> </ul>
	<ul style="list-style-type: none"> <li>• Das Netzkabel kann Quelle elektrischer Schläge sein.</li> </ul>	<ul style="list-style-type: none"> <li>• Ersetzen Sie das Netzkabel vor Inbetriebnahme, falls es beschädigt ist.</li> <li>• Halten Sie alle Anschlüsse trocken und in ausreichendem Abstand zum Boden. Netzkabel dürfen nicht im Wasser liegen oder an Stellen, an denen sie in Kontakt mit Wasser kommen könnten. Berühren Sie den Stecker niemals mit nassen Händen.</li> </ul>
	<ul style="list-style-type: none"> <li>• Zu elektrischen Schlägen kann es kommen, wenn der Luftkompressor nicht ordnungsgemäß betrieben wird.</li> </ul>	<ul style="list-style-type: none"> <li>• Ziehen Sie nicht am Netzkabel, um den Stecker aus der Steckdose zu ziehen.</li> <li>• Betreiben Sie den Luftkompressor niemals unter feuchten Umgebungsbedingungen oder unter freiem Himmel, wenn es regnet.</li> </ul>
	<ul style="list-style-type: none"> <li>• Wenn unqualifiziertes Personal versucht, den Luftkompressor zu reparieren, kann dies zu Verletzungen führen.</li> </ul>	<ul style="list-style-type: none"> <li>• Betreiben Sie den Luftkompressor niemals, wenn die Schutzverkleidung bzw. die Abdeckungen entfernt oder beschädigt sind.</li> <li>• Der Luftkompressor darf nur von zugelassenen Kundendiensttechnikern in Übereinstimmung mit nationalen und örtlicheelektrotechnischen Vorschriften verdrahtet oder repariert werden.</li> <li>• Vor dem Öffnen des elektrischen Schaltschranks muss der Luftkompressor stets ausgeschaltet werden; anschließend muss der Druck abgelassen und der Luftkompressor von der Spannungsquelle getrennt werden.</li> <li>• Lassen Sie den Luftkompressor abkühlen. Gehen Sie niemals davon aus, dass der Luftkompressor betriebssicher ist, nur weil er gerade nicht läuft. Er könnte jederzeit unvermittelt starten!</li> </ul>

## Sicherheitshinweise



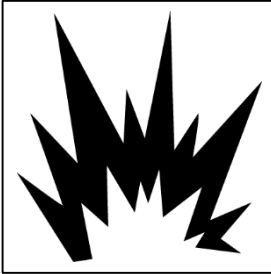

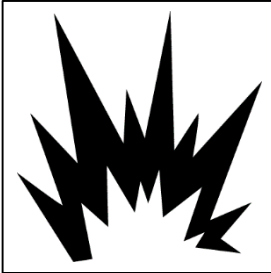

**Lesen sie alle sicherheitshinweise durch, bevor sie den kompressor betreiben**

Gefahr	Potenzielle Folgen	Unfallverhütung
<p style="text-align: center;"><b>Explosions oder Brandgefahr</b></p> <div style="text-align: center;">  </div>	<ul style="list-style-type: none"> <li>• Durch normale elektrische Funken an Motor und Druckschalter kann es zu schweren Verletzungen, eventuell mit Todesfolge, kommen.</li> </ul>	<ul style="list-style-type: none"> <li>• Betreiben Sie den Luftkompressor stets in einer gut gelüfteten Umgebung, in der es keinerlei leicht entzündliche Dämpfe, brennbaren Staub, Gase oder sonstige brennbare Materialien gibt.</li> <li>• Wenn leicht entzündliche Materialien gespritzt werden, muss der Luftkompressor mindestens 6 Meter vom Spritzbereich entfernt aufgestellt werden. (Unter Umständen ist dazu ein Verlängerungsschlauch erforderlich.)</li> </ul>
<div style="text-align: center;">  </div>	<ul style="list-style-type: none"> <li>• Es kann zu schweren Verletzungen kommen, wenn Lüftungsöffnungen des Luftkompressors blockiert werden, so dass er sich überhitzt und in Brand gerät.</li> </ul>	<ul style="list-style-type: none"> <li>• Stellen Sie niemals Gegenstände gegen oder auf den Luftkompressor. Betreiben Sie den Luftkompressor mindestens 30 cm entfernt von jeder Wand bzw. jedem Hindernis, dass eine ordnungsgemäße Luftzufuhr blockieren würde.</li> </ul>
<p style="text-align: center;"><b>Brandgefahr</b></p> <div style="text-align: center;">  </div>	<ul style="list-style-type: none"> <li>• Es kann zu Unfällen mit schweren Verletzungen, eventuell mit Todesfolge, kommen, wenn ein Druckluftbehälter explodiert, weil die Druckluftbehälter nicht ordnungsgemäß gewartet wurden.</li> </ul>	<ul style="list-style-type: none"> <li>• Lassen Sie den Druckluftbehälter täglich nach jedem Einsatz des Luftkompressors ab, um zu verhindern, dass sich Feuchtigkeit im Druckluftbehälter ansammelt.</li> <li>• Wenn der Druckluftbehälter leckt, muss er sofort ausgewechselt werden. Der Druckluftbehälter oder seine Anbauteile dürfen niemals repariert, geschweißt oder modifiziert werden.</li> </ul>
	<ul style="list-style-type: none"> <li>• Es kann zu Unfällen mit schweren Verletzungen, eventuell mit Todesfolge, durch Luftkompressorfehlfunktionen oder explodierende Zubehörteile kommen, wenn falsche Systemkomponenten, Anbauteile oder Zubehörteile verwendet werden.</li> </ul>	<ul style="list-style-type: none"> <li>• Herstellerseitig eingestellte Druckwerte dürfen niemals geändert werden.</li> <li>• Der von den Herstellern für die Anbauteile spezifizizierte Höchstdruck-Nennwert darf niemals überschritten werden.</li> <li>• Verwenden Sie aufgrund möglicher extremer Wärmeentwicklung keine Kunststoffrohre oder gelötete Zinkrohrmuffen für die Druckleitung.</li> <li>• Benutzen Sie den Luftkompressor niemals, um kleine Gegenstände mit niedrigem Druck – z.B. Spielzeuge – aufzupumpen.</li> <li>• Alle Schläuche und Befestigungen sind für Aufstellungsortgebrauch mit dem maximal zulässigen Funktion Druck des beweglichen Kompressors verwendbar.</li> <li>• Verwenden Sie nur Original-Ersatzteile von SENCO für Ihren Luftkompressor.</li> </ul>

## Sicherheitshinweise

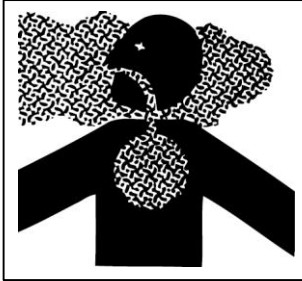



**Lesen sie alle sicherheitshinweise durch, bevor sie den kompressor betreiben**

Gefahr	Potenzielle Folgen	Unfallverhütung
<p style="text-align: center;"><b>Gefahr durch Einatmen</b></p> 	<ul style="list-style-type: none"> <li>• Es kann zu Unfällen mit schweren Verletzungen, eventuell mit Todesfolge, kommen, wenn Druckluft eingeatmet wird. Der Druckluftstrom kann Kohlenmonoxid, giftige Dämpfe oder Festkörper enthalten.</li> <li>• Spritzmittel wie Farbe, Farblösungsmittel, Abbeizmittel, Insektizide, Herbizide usw. enthalten schädliche Dämpfe und Giftstoffe.</li> </ul>	<ul style="list-style-type: none"> <li>• Vom Luftkompressor stammende Druckluft darf weder direkt noch überein an den Luftkompressor angeschlossenes Atemgerät eingeatmet werden. Betreiben Sie den Luftkompressor stets in einer gut gelüfteten Umgebung.</li> <li>• Befolgen Sie alle Sicherheitshinweise, die den Materialien beiliegen, die Sie im Spritzverfahren verarbeiten. Bei der Arbeit mit bestimmten Materialien kann es notwendig sein, ein Atemschutzgerät zu benutzen.</li> </ul>
<p style="text-align: center;"><b>Gefahr von Verbrennungen</b></p> 	<ul style="list-style-type: none"> <li>• Das Berühren zugänglicher Metallteile kann erhebliche Verletzungen verursachen. Diese Bereiche können auch einige Zeit nach Ausschalten des Luftkompressors noch heiß sein.</li> </ul>	<ul style="list-style-type: none"> <li>• Achten Sie stets darauf, dass Sie weder mit Ihren Körperteilen noch mit irgendwelchen Materialien frei zugängliche Teile des Luftkompressors berühren, Motor, oder Rohrleitungen.</li> </ul>
<p style="text-align: center;"><b>Gefahr durch Herumfliegende Gegenstände</b></p> 	<ul style="list-style-type: none"> <li>• Durch den Druckluftstrom kann es zu Weichgewebeschäden kommen.</li> </ul>	<ul style="list-style-type: none"> <li>• Tragen Sie stets eine von der OSHA (US-Arbeitsschutzbehörde) vorgeschriebene "Z87"-Schutzbrille, um Ihre Augen gegen herumfliegende Fremdkörper zu schützen.</li> <li>• Halten Sie den Druckluftstrom niemals auf einen Teil Ihres eigenen Körpers odeauf Körperteile anderer Personen oder auf Tiere. r</li> <li>• Lassen Sie den Luftkompressor niemals unbeaufsichtigt, während Druckluft anliegt. Schalten Sie den Luftkompressoaus und lassen Sie den Druck ab, bevor Sie Wartungsarbeiten durchführen oder Werkzeuge oder Zubehör anschließen.</li> </ul>
<p style="text-align: center;"><b>Immer Schutzbrillen Verwenden</b></p> 	<ul style="list-style-type: none"> <li>• Durch lose Fremdkörper, die durch den Druckluftstrom stark beschleunigt werden, kann es zu schweren Verletzungen kommen.</li> </ul>	<ul style="list-style-type: none"> <li>• Halten Sie stets einen Sicherheitsabstand zu anderen Personeneund zu Tieren ein, wenn Sie den Luftkompressor betreiben.</li> <li>• Transportieren Sie den Luftkompressor nicht, während der Druckluftbehälter unter Druck steht. Versuchen Sie nicht, den Luftkompressor zu bewegen, indem Sie am Netzkabel ziehen.</li> </ul>

## Sicherheitshinweise

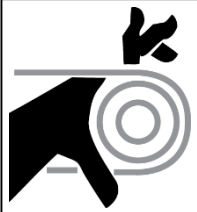

Lesen sie alle sicherheitshinweise durch, bevor sie den kompressor betreiben

Gefahr	Potenzielle Folgen	Unfallverhütung
<p><b>Gefahr durch Nachlässigkeit</b></p>  <p><b>Achtung: Gerät Läuft Ohne Signal An</b></p> 	<ul style="list-style-type: none"> <li>Gefahr von Personenschäden durch bewegliche Bauteile. Dieser Luftkompressor beginnt automatisch mit dem Arbeitszyklus, wenn der Druckschalter in Position <b>EIN (1)</b>/Auto ist.</li> <li>Gefahr von Personenschäden durch nachlässige Bedienung.</li> </ul>	<ul style="list-style-type: none"> <li>Schalten Sie den Luftkompressor immer aus, wenn er nicht gebraucht wird. Lassen Sie den Druck aus dem Druckluftschlauch ab und ziehen Sie deStecker aus der Steckdose, bevor Sie Wartungsarbeiten durchführen. Alle Reparaturen am Luftkompressor sollten durch einen zugelassenen Kundendiensttechniker durchgeführt werden. Gehen Sie niemals davon aus, dass der Luftkompressor betriebssicher ist, nur weil er gerade nicht läuft. Er könnte jederzeit unvermittelt starten!</li> <li>Betreiben Sie den Luftkompressor niemals ohne die Schutzabdeckungen bzw. -verkleidung. Tauschen Sie beschädigte Schutzabdeckungen bzw. -verkleidungsteile aus, bevor Sie den Luftkompressor benutzen.</li> </ul>
<p><b>Gerfahr durch Beschädigung des Kompressors</b></p> 		<ul style="list-style-type: none"> <li>Lassen Sie den Luftkompressor niemals durch Kinder oder Jugendliche bedienen. Gehen Sie immer vorsichtig vor.</li> <li>Betreiben Sie den Luftkompressor nicht, wenn Sie übermüdet sind oder unter deEinfluss von Alkohol oder Drogen stehen.</li> <li>Sie sollten wissen, wie der Luftkompressor angehalten werden kan. Machen Sie sich von dem Einsatz gründlich mit den Bedienelementen vertraut.</li> </ul>
<p><b>Gefahr durch Bewegliche Bauteile</b></p>	<ul style="list-style-type: none"> <li>Gefahr, dass größere Reparaturen erforderlich werden.</li> </ul>	<ul style="list-style-type: none"> <li>Betreiben Sie den Luftkompressor nicht ohne Luftfilter.</li> <li>Betreiben Sie den Luftkompressor nicht in einer Umgebung, die korrosiv wirkt.</li> <li>Betreiben Sie den Luftkompressor immin einer stabilen, sicheren Aufstellpositioum zu verhindern, dass er umkippt.</li> <li>Befolgen Sie die in diesem Handbuch abgedruckte Wartungsanleitung.</li> </ul>

**! Bewahren Sie Diese Anleitung Gut Auf !**

## Leistungsmerkmale des Kompressors

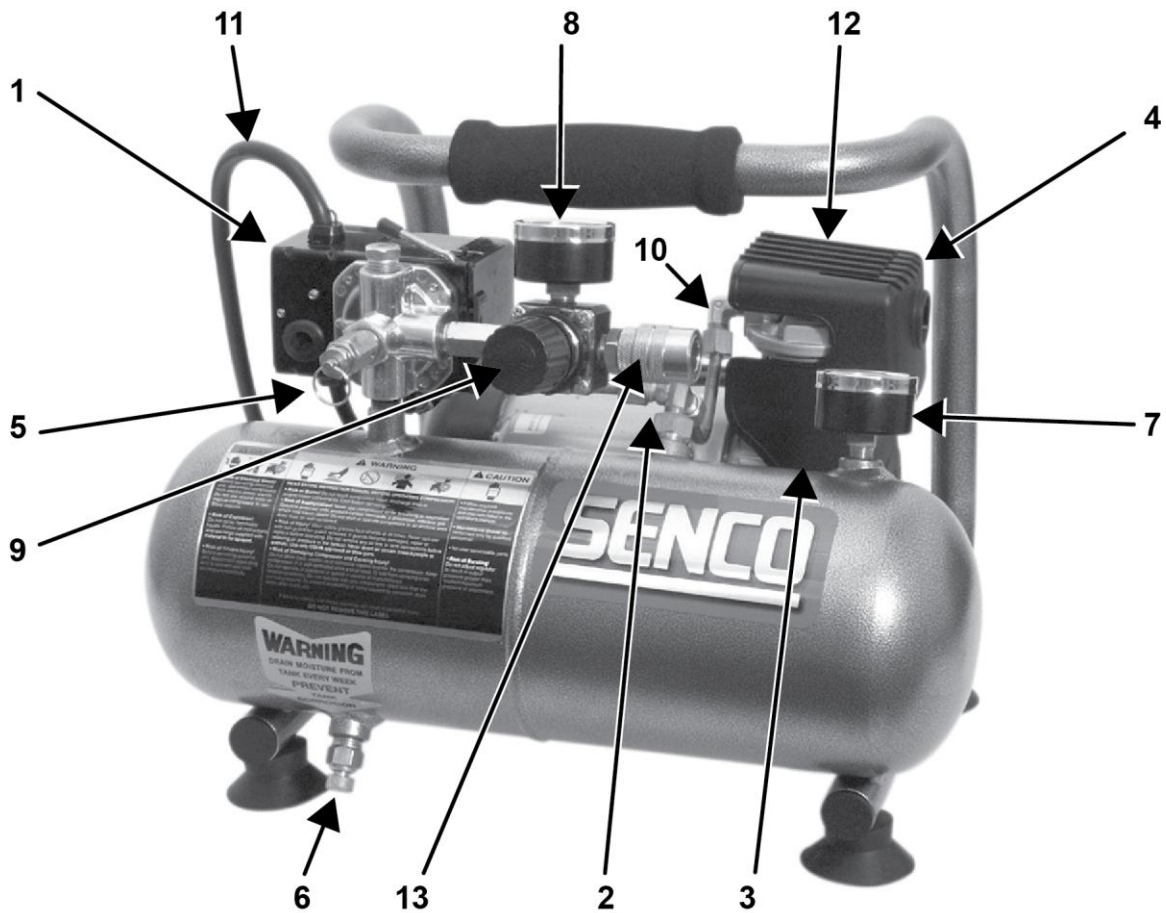

1.	Motor / Druckschalter
2.	Thermoschalter / Reset-Schalter
3.	Lufteinlassfilter
4.	Luftkompressorpumpe
5.	Sicherheitsüberdruckventil
6.	Druckluftbehälter-Ablassventil
7.	Manometer des Druckluftbehälters
8.	Manometer an der Auslassöffnung
9.	Druckregler
10.	Druckleitung
11.	Netzkabel
12.	Lüftungsöffnungen / Schutzabdeckung
13.	Schnellkupplung



## Leistungsmerkmale des Kompressors

**1) Motor / Druckschalter:** Dieser Schalter dient dazu, den Luftkompressor zu starten und zu stoppen. Wenn dieser Schalter in Position **ON (1)** gelegt wird, wird automatisch Spannung an den Druckschalter gelegt, mit der der Motor anlaufen kann, wenn der Druck im Druckluftbehälter unter den herstellerseitig eingestellten Einschaltdruck fällt. Wenn die **ON (1)**-Option eingeschaltet ist, stoppt der Druckschalter den Motor, wenn der Druck im Druckluftbehälter den herstellerseitig eingestellten Ausschaltdruck erreicht. Aus Sicherheitsgründen ist dieser Schalter außerdem seitlich mit einem Druckablassventil ausgestattet, das so ausgelegt ist, dass es automatisch Druckluft vom Luftkompressorumpfenkopf und seiner Druckleitung ablässt, wenn der Luftkompressor den Ausschaltdruck erreicht oder ausgeschaltet wird. Auf diese Weise kann der Motor dann druckfrei neu gestartet werden. Wenn der Schalter in Position **OFF (0)** gelegt wird, wird der Druckschalter spannungsfrei gesetzt und der Luftkompressor gestoppt.

**2) Überlastung des Motors:** Der Motor verfügt zum Schutz vor Überlastungen über einen Unterbrechungsschalter an der Pumpe. Dieser Unterbrechungsschalter wird bei übermäßiger Stromabnahme zum Schutz des Motors und des Betreibers ausgelöst. Setzen Sie den Unterbrechungsschalter zurück, indem Sie den schwarzen Kunststoffstift in das Gehäuse zurückdrücken. Zurücksetzen Schalters nach dem Auslösen.

**3) Lufteinlassfilter:** Dieser Filter soll die der Pumpe zugeführte Luft reinigen. Um sicherzustellen, dass die Pumpe laufend mit sauberer, kalter und trockener Luft versorgt wird, muss dieser Filter immer sauber sein, und die Ansaugöffnungen dürfen nicht blockiert werden. Um den Filter mit warmem Seifenwasser reinigen zu können, muss er ausgebaut werden. Spülen Sie anschließend den Filter und trocknen Sie ihn an der Luft.

**4) Luftkompressorpumpe:** Zwecks Drucklufterzeugung bewegt sich der Kolben im Zylinder auf und ab. Beim Abwärtshub wird Luft durch das Einlassventil angesaugt, während das Auslassventil geschlossen bleibt. Beim Aufwärtshub wird die Luft verdichtet, das Einlassventil wird geschlossen, und die Druckluft wird durch das Auslassventil in die Druckleitung und durch das Rückschlagventil in den Druckluftbehälter gedrückt.

**5) Sicherheitsüberdruckventil:** Dieses Ventil ist so ausgelegt, dass es Systemausfälle durch Ablassen des Drucks aus dem System verhindert, wenn die Druckluft einen voreingestellten Druckwert erreicht. Das Ventil ist herstellerseitig voreingestellt und darf auf keinen Fall verstellt werden. Ziehen Sie am Ring, um zu prüfen, ob dieses Ventil ordnungsgemäß funktioniert. Daraufhin muss Luft entweichen. Sobald der Ring losgelassen wird, schließt das Ventil wieder.

**6) Druckluftbehälter-Ablassventil:** Das Ablassventil dient dazu, Feuchtigkeit aus dem bzw. den Druckluftbehältern zu entfernen, nachdem der Luftkompressor ausgeschaltet wurde. **Versuchen Sie NIEMALS, das Ablassventil zu öffnen, wenn im Druckluftbehälter noch ein Druck von mehr als 690 hPa 0.7 bar herrscht!** Drehen Sie den Ventilknopf nach links, um das Ablassventil zu öffnen. Kippen Sie den Druckluftbehälter, um sicher zu gehen, dass das gesamte Kondenswasser durch das Ventil ablaufen kann.

**7) Manometer Am Druckluftbehälter:** Das Manometer am Druckluftbehälter zeigt den Druck der in dem bzw. den Druckluftbehältern gepufferten Druckluft an.

**8) Manometer An Der Auslassöffnung:** Das Manometer an der Auslassöffnung zeigt den Druck der an der Auslassöffnung des Druckreglers anliegenden Druckluft an. Dieser Druck wird durch den Druckregler geregelt und entspricht immer höchstens dem Druck in dem bzw. den Druckluftbehältern.

**9) Druckregler:** Der Druck der Luft, die aus dem Druckluftbehälter kommt, wird mit Hilfe des Reglerknopfes geregelt. Drehen Sie den Druckreglerknopf nach rechts, um den Auslassdruck zu erhöhen, und nach links, um den Auslassdruck zu reduzieren. Für den empfohlenen Druckbereich befolgen Sie bitte die Betriebsanleitung des Geräts.

**10) Druckleitung:** Bitte beachten Sie, dass sich die Druckleitung stark erwärmt. **Heiße Oberfläche Abdeckung nicht entfernen. Hohe Temperatur nach Dauerbetrieb.**

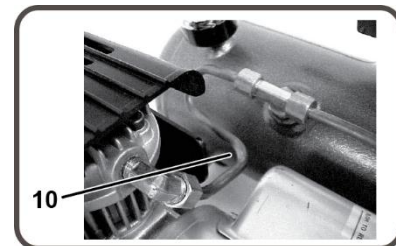
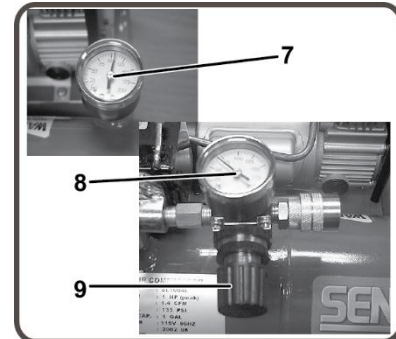
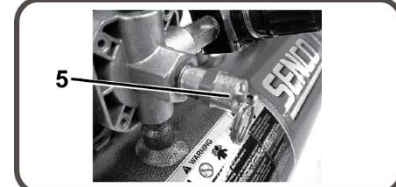
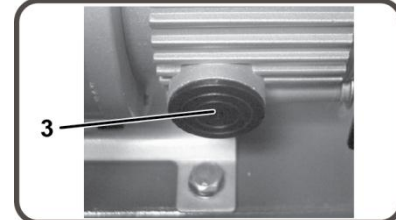
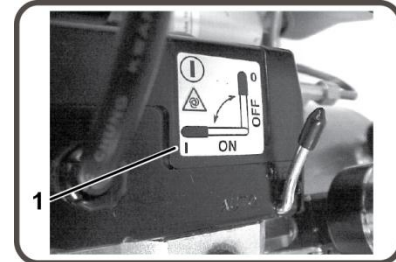

## Vorbereitung

### Einrichten Für Die Erstmalige Inbetriebnahme

1. Lesen Sie alle Sicherheitshinweise, bevor Sie mit dem Einrichten des Luftkompressors beginnen.

### Aufstellort

#### Achtung

Um Beschädigungen am Luftkompressor zu vermeiden, darf er in Längs- oder Querrichtung nicht um mehr als 10 gekippt werden.

1. Stellen Sie dem Luftkompressor mindestens 30 cm von Hindernissen entfernt auf, die eine ordnungsgemäße Luftzufuhr blockieren könnten.

Stellen Sie den Luftkompressor nicht in einer Umgebung auf, in der:

- Es Hinweise auf das Vorhandensein von Öl- oder Gaslecks gibt.
- Leicht entzündliche Gasdämpfe oder Materialien vorhanden sein können.

#### Warnung



Es besteht die Gefahr schwerer Verletzungen, eventuell mit Todesfolge, wenn elektrische Funken aus dem Motor und Druckschalter in Kontakt mit leicht entzündlichen Dämpfen, brennbarem Staub, Gasen oder sonstigen brennbaren Materialien kommen. Wenn der Luftkompressor für Farbspritzarbeiten benutzt wird, sollte er so weit wie möglich vom Arbeitsbereich entfernt aufgestellt werden, wobei Verlängerungsschläuche und nicht Verlängerungskabel verwendet werden sollten.

- Wenn die Lufttemperatur unter 0°C fällt oder über 40°C steigt.
- Wenn die Luft extrem verschmutzt ist oder Wasser vom Luftkompressor angesogen werden könnte.

### Elektrik

#### Gefahr



Unsachgemäßer Anschluss des Erdleiters des Luftkompressors kann die Gefahr elektrischer Schläge, ggf. mit tödlichen Folgen, nach sich ziehen. Bitte Sie einen ausgebildeten Elektrotechniker oder Kundendiensttechniker um Rat, wenn Sie nicht sicher sind, ob die Steckdose ordnungsgemäß geerdet ist. Verwenden Sie keinen Adapter – gleich welcher Art – für dieses Gerät. Wenn das Netzkabel oder der Netzstecker repariert oder ausgetauscht werden muss, dürfen Sie den Erdungsdraht nicht an einen der Flachstifte (gilt nur für die USA) anschließen. Der Draht mit der grünen Isolierung mit oder ohne gelbe Streifen ist der Erdungsdraht.

#### Warnung



Dieses Gerät muss geerdet werden. Sollte es eine Störung geben oder das Gerät vollständig ausfallen, so bietet die Erdung dem elektrischen Strom einen Weg mit geringstem Widerstand, um die Gefahr elektrischer Schläge zu vermeiden. Dieses Gerät ist mit einem Netzkabel ausgerüstet, das einen Geräteerdungsleiter sowie einen Stecker mit Erdungsstift hat. Der Stecker muss in eine ordnungsgemäß installierte und entsprechend örtlichen Vorschriften und Verordnungen geerdete, passende Steckdose gesteckt werden.

1. SENCO® EMPFIEHLT NICHT DIE VERWENDUNG VON VERLÄNGERUNGSKABELN, da dies zu Spannungsverlusten und Überhitzung des Motors führen kann. Empfohlen wird vielmehr die Verwendung eines Verlängerungsschlauchs und nicht die Benutzung eines Verlängerungskabels. Wenn die Benutzung eines Verlängerungskabels unvermeidbar ist, so sollte dieses an einen Erdschluss-Schutzschalter angeschlossen werden, wie er in Schaltkästen oder geschützten Steckdosen installiert ist.

Bei der Benutzung eines Verlängerungskabels ist Folgendes zu beachten:

<u>Kabellänge</u>	<u>Drahtdurchmesser</u>
Bis 7,5 m	12 AWG
Bis 30 m	10 AWG
Bis 50 m	8 AWG
Bis 75 m	6 AWG

Verwenden Sie ausschließlich Verlängerungskabel, die mindestens elektrische Nennwerte haben, die denen des Geräts entsprechen. Benutzen Sie niemals beschädigte Verlängerungskabel. Prüfen Sie das Verlängerungskabel vor dem Gebrauch und ersetzen Sie es, wenn es beschädigt ist. Benutzen Sie das Verlängerungskabel nicht unsachgemäß und ziehen Sie nicht an dem Kabel, um den Stecker von der Steckdose zu trennen. Halten Sie das Kabel fern von Wärmequellen und scharfen Kanten. Schalten Sie immer zuerst den Hauptschalter des Luftkompressors aus, bevor Sie den Stecker aus der Steckdose ziehen.

## Betrieb

### Checkliste Für Vorbereitung Auf Die Inbetriebnahme

1. Lassen Sie ggf. vorhandene Feuchtigkeit vollständig aus dem Druckluftbehälter des Luftkompressors ab. Lassen Sie dazu den überschüssigen Druck über ein Druckluftwerkzeug ab und öffnen Sie anschließend das Ablassventil an der Unterseite des Druckluftbehälters. Regulieren Sie übermäßigen Druck durch Ziehen am Ring des Sicherheitsventils oder mithilfe eines Druckluftwerkzeugs, öffnen Sie anschließend das Luftdruckventil am Boden des Druckluftbehälters. Schließen Sie das Ventil nach dem Ablassvorgang wieder dicht zu.



**WARNUNG: Verletzungsgefahr. Versuchen Sie NIEMALS, das Ablassventil zu öffnen, wenn im Druckluftbehälter noch ein Druck von mehr als 700 hPa herrscht!**

2. Stellen Sie sicher, dass der Motorschalter des Luftkompressors in Position **OFF (0)** ist.
3. Stellen Sie sicher, dass alle Sicherheitsüberdruckventile ordnungsgemäß funktionieren.
4. Stellen Sie sicher, dass alle Schutzabdeckungen und -verkleidungsteile installiert und sicher befestigt sind.

### Inbetriebnahme

1. Stellen Sie sicher, dass der Hebel am Druckschalterkasten in Position **OFF (0)** ist.
2. Stecken Sie den Netzstecker in eine geerdete Steckdose.
3. Legen Sie den Hebel am Druckschalterkasten in Position **ON (1)**.
4. So kann der Luftkompressor **STARTEN**, um Druck in den Druckluftbehältern aufzubauen, und dann wieder **STOPPEN**, sobald der richtige Druck erreicht wird. Wenn der Druck dann während der Arbeit wieder fällt, **STARTET** der Luftkompressor erneut, um Druck aufzubauen.
5. Stellen Sie den Druck durch Drehen des Druckreglerknopfes nach links auf niedrigeren Druck und durch Drehen nach rechts auf höheren Druck ein.
6. Wenn Sie ungewöhnliche Geräusche oder Vibrationen bemerken, müssen Sie den Luftkompressor stoppen und den Abschnitt "Störungsbeseitigung" Konsultieren.

### Ausschalten

1. Legen Sie den Hebel am Druckschalterkasten in Position **OFF (0)**, um den Luftkompressor zu stoppen. Stoppen Sie den Luftkompressor NIEMALS durch Herausziehen des Steckers aus der Netzsteckdose. Andernfalls kann es zu einem tödlichen Elektroschocks kommen.
2. Lassen Sie die Luft aus dem Druckluftbehälter ab, indem Sie die Luft über eines der angeschlossenen Druckluftwerkzeuge ablassen oder indem Sie den Ring am Sicherheitsüberdruckventil ziehen.
3. Sobald der Druck in den Druckluftbehältern unter 700 hPa gefallen ist, können Sie das Ablassventil am Boden jedes Druckluftbehälters öffnen.
4. Lassen Sie den Luftkompressor abkühlen.
5. Reiben Sie den Luftkompressor sauber und bewahren Sie ihn an einem sicheren, frostfreien Ort auf.

## Wartung

Lesen Sie diese Anleitung durch, bevor Sie Wartungsarbeiten durchführen. Die folgenden Prozeduren sind zu befolgen, wenn der Luftkompressor zwecks Wartungs- oder Servicearbeiten gestoppt werden soll.

1. Schalten Sie den Luftkompressor aus.



**Warnung: Gehen Sie niemals davon aus, dass der Luftkompressor betriebssicher ist, nur weil er gerade nicht läuft. Er könnte jederzeit unvermittelt starten!**

2. Trennen Sie das Netzkabel von der Spannungsversorgung.
3. Öffnen Sie alle Ablassventile.
4. Warten Sie, bis sich der Luftkompressor abgekühlt hat, bevor Sie mit den Servicearbeiten beginnen.

Wartungstabelle			
PROZEDUR	TÄGL.	WÖCHENTL.	MONATL.
Kondenswasser aus Druckluftbehälter(n) ablassen	X		
Auf ungewöhnliche Geräusche/Vibrationen prüfen	X		
Auf Luftlecks prüfen	X		
Luftfilter prüfen		X	
Außenseite des Kompressors reinigen		X	
Sicherheitsüberdruckventil prüfen			X

## Störungsbeseitigung

### Symptom 1: Motor läuft nicht oder startet nicht neu.

Mögliche Ursache	Störungsbeseitigungsmassnahme
• Netzstecker ist nicht eingesteckt.	• Netzstecker in eine geerdete Netzsteckdose stecken.
• Motor-/Druckschalter ist in Position <b>OFF (0)</b> .	• Schalter in Position <b>ON (1)</b> legen.
• Thermoschalter des Motors wurde ausgelöst.	• Luftkompressor einschalten, warten, bis sich der Motor abgekühlt hat und dann Motorleistungsschalter prüfen.
• Sicherung ist durchgebrannt, oder Leistungsschalter wurde ausgelöst.	<ul style="list-style-type: none"> <li>• Sicherung auswechseln oder Leistungsschalter nullstellen.</li> <li>• Ampere-Nennwert der Sicherung prüfen.</li> <li>• Prüfen, ob die Spannung zu niedrig ist.</li> <li>• Andere Elektrogeräte vom Stromkreis trennen oder Luftkompressor an eigenen Nebenstromkreis anschließen.</li> </ul>
• Falscher Drahtdurchmesser bzw. zu langes Verlängerungskabel.	• Tabelle auf Seite 10 konsultieren, um richtigen Drahtdurchmesser und richtige Netzkabellänge zu ermitteln.
• Druck in Druckluftbehältern höher als der für den Motor-/Druckschalter eingestellte "Einschaltdruck."	• Motor startet automatisch, wenn der Druck im Druckluftbehälter unter den "Einschaltdruck" des Motor-/Druckschalters fällt.
• Druckablassventil am Motor-/Druckschalter hat nicht den Druck aus dem Kompressorumpfenkopf abgelassen.	• Leitung entleeren, indem Schalter in Position <b>OFF (0)</b> gelegt wird.
• Defekter Motor, Motorkondensator, Motor-/Druckschalter oder defektes Rückschlagventil.	• Senco-Kundendienst verständigen.

### Symptom 2: Wenn die Start-/Stopp-Option eingeschaltet wurde, läuft der Motor ununterbrochen.

Mögliche Ursache	Störungsbeseitigungsmassnahme
• Motor-/Druckschalter schaltet Motor nicht aus, wenn der Luftkompressor den "Einschaltdruck" erreicht, und das Sicherheitsüberdruckventil wird geöffnet.	• Motor-/Druckschalter in Position <b>OFF (0)</b> legen. Wenn der Motor nicht ausgeschaltet wird, Netzstecker des Luftkompressors ziehen. Wenn die elektrischen Kontakte zusammengeschmolzen sind, Druckschalter auswechseln.
• Der Luftkompressor ist falsch dimensioniert.	• Druck auf die Nennkapazität des Luftkompressors begrenzen. Entweder ein kleineres Druckluftwerkzeug oder einen größeren Luftkompressor benutzen.

### Symptom 3: Aus dem Ablassventil am Motor-/Druckschalter entweicht weiter Luft, nachdem der Motor gestoppt wurde.

Mögliche Ursache	Störungsbeseitigungsmassnahme
• Rückschlagventil "hängt" in Position <b>Offen</b> .	• Entfernen, reinigen oder auswechseln.

### Symptom 4: Aus dem Ablassventil am Motor-/Druckschalter entweicht weiter Luft, wenn der Motor läuft.

Mögliche Ursache	Störungsbeseitigungsmassnahme
• Defekter Motor-/Druckschalter.	• Auswechseln.

### Symptom 5: Aus dem Sicherheitsüberdruckventil entweicht Luft.

Mögliche Ursache	Störungsbeseitigungsmassnahme
• Möglicherweise defektes Sicherheitsüberdruckventil.	• Sicherheitsüberdruckventil manuell durch Ziehen des Rings betätigen. Wenn es immer noch leckt, muss es ausgewechselt werden.
• Zu hoher Druck in Druckluftbehältern.	• Defekter Motor-/Druckschalter. Auswechseln.

<b>Störungsbeseitigung</b>	
<b>Symptom 6: Aus den Armaturen entweicht Luft.</b>	
<b>Mögliche Ursache</b>	<b>Störungsbeseitigungsmassnahme</b>
<ul style="list-style-type: none"> <li>• Armaturen sind nicht dicht genug.</li> </ul>	<ul style="list-style-type: none"> <li>• Armaturen an der Stelle festziehen, wo entweichende Luft zu hören ist. Armaturen mit Seifenwasser auf Dichtigkeit prüfen. Nicht übermäßig festziehen.</li> </ul>
<b>Symptom 7: Aus dem Druckluftbehälter entweicht Luft.</b>	
<b>Mögliche Ursache</b>	<b>Störungsbeseitigungsmassnahme</b>
<ul style="list-style-type: none"> <li>• Defekter oder korrodierter Druckluftbehälter.</li> </ul>	<ul style="list-style-type: none"> <li>• Druckluftbehälter muss ausgewechselt werden. Nicht versuchen, den Druckluftbehälter zu reparieren! Schweißen, reparieren, und modifizieren nicht erlaubt.</li> </ul>
<b>Symptom 8: Aus dem Einlassfilter entweicht Luft.</b>	
<b>Mögliche Ursache</b>	<b>Störungsbeseitigungsmassnahme</b>
<ul style="list-style-type: none"> <li>• Beschädigtes Einlassventil (Reed-Ventil).</li> </ul>	<ul style="list-style-type: none"> <li>• SENCO-Kundendienst anrufen.</li> </ul>
<b>Symptom 9: Ungenügender Druck im Druckluftwerkzeug oder Zubehörteil.</b>	
<b>Mögliche Ursache</b>	<b>Störungsbeseitigungsmassnahme</b>
<ul style="list-style-type: none"> <li>• Druckreglerknopf nicht auf ausreichend hohen Druckwert eingestellt oder defekter Druckregler.</li> </ul>	<ul style="list-style-type: none"> <li>• Druckreglerknopf auf richtigen Wert einstellen oder auswechseln.</li> </ul>
<ul style="list-style-type: none"> <li>• Lufteinlassfilter blockiert.</li> </ul>	<ul style="list-style-type: none"> <li>• Reinigen.</li> </ul>
<ul style="list-style-type: none"> <li>• Luftlecks.</li> </ul>	<ul style="list-style-type: none"> <li>• Auf Lecks prüfen und reparieren.</li> </ul>
<ul style="list-style-type: none"> <li>• Luftkompressor ist für das Druckluftwerkzeug nicht ausreichend dimensioniert.</li> </ul>	<ul style="list-style-type: none"> <li>• Druckluftanforderungen der Zubehörteile prüfen. Wenn diese höher sind als der m_/min-Wert bzw. die Druckluftleistung des Luftkompressors, benötigen Sie einen größer dimensionierten Luftkompressor.</li> </ul>
<b>Symptom 10: Luftkompressor produziert nicht genug Druckluft.</b>	
<b>Mögliche Ursache</b>	<b>Störungsbeseitigungsmassnahme</b>
<ul style="list-style-type: none"> <li>• Lufteinlassfilter blockiert.</li> </ul>	<ul style="list-style-type: none"> <li>• Reinigen.</li> </ul>
<ul style="list-style-type: none"> <li>• Beschädigtes Ventil (Reed-Ventil).</li> </ul>	<ul style="list-style-type: none"> <li>• Druckluftbehälter entleeren und Auffüllzeit messen. Mit den Spezifikationen vergleichen. Wenn Istwert niedriger ist, Pumpenkopf ausbauen und Ventilplatte prüfen, reinigen oder auswechseln.</li> </ul>
<b>Symptom 11: Feuchtigkeit im Druckluftbehälter.</b>	
<b>Mögliche Ursache</b>	<b>Störungsbeseitigungsmassnahme</b>
<ul style="list-style-type: none"> <li>• Kondenswasser im Druckluftbehälter, das durch hohe Luftfeuchtigkeit oder dadurch verursacht wird, dass der Luftkompressor nicht lange genug läuft.</li> </ul>	<ul style="list-style-type: none"> <li>• Druckluftbehälter nach jedem Einsatz entleeren. Bei feuchtem Wetter den Druckluftbehälter ablassen und Lufteinlassfilter benutzen.</li> </ul>

## Technische Daten

**Modell-Nr.: PC 1010**

<b>Motor</b>	Leistung	0.5 HP (Spitze)
	Spannung	230V
	Stromstärke	2A
	Hz.	50
	Wechselstrom	1
	Drehzahl	2850
<b>Kompressorpumpe</b>	Anzahl der Zylinder	1
	Kompressionsphasen	1
	Kurbelgehäuse	Aluminium
	Lager	Kugellager
	Zylinder	Aluminium
	Ventile	Reed, 1
	Pumpenkopf	Aluminium
	Filter	Einsatz
<b>Motor-/Druckschalteinstellung</b>	Ausschalt-Druck	8.6 bar (125 PSI)
	Einschalt-Druck	6.6 bar (95 PSI)
	Reglage	ON (1) / OFF (0)
<b>Druckluftbehälter</b>	Kapazität	3.8 Liter (1 Gallon)
<b>Druckluftleistung</b>	L/Min Luft Verdrängung	32 (1.1 CFM)
	Durchsatz bei @ 2.8 bar	17 (0.6 CFM @ 40 PSI)
	Durchsatz bei @ 6.2 bar	10 (0.35 CFM @ 90 PSI)
	Durchsatz bei @ 6.9 bar	9 (0.31 CFM @ 100 PSI)
	Höchstdruck	8.6 bar (125 PSIG)
	Aufpumpzeit: 0-9 bar	160 sekunden
	Erholungszeit: 7-9 bar	48 sekunden
<b>Gewicht</b>	Netto	9.1 kg
<b>Maße</b>	Grundversion L x B x H	36 x 33 x 25 cm
<b>Noise</b>	Measured sound power level (dB)	78 dBA
	Guaranteed sound power level (dB)	81 dBA

## Konformitätserklärung

Wir Senco Brands, Inc.  
 von 4270 Ivy Pointe Blvd., Cincinnati, Ohio 45245  
 in Übereinstimmung mit den folgenden Richtlinien:  
**Maschinenrichtlinie 2006/42/EG**  
**Pressure Vessel Directive 2009/105/EC.**  
**EMC Directive 2004/108/EC**  
**Low Voltage Directive 2006/95/EC**  
**RoHS Directive 2011/65/EU**  
**Noise Emission Directive 2005/88/EC**  
 erklären in alleiniger Verantwortung, dass: Modell/Modelle:  
**P C 10 10 EU, P C 10 10 EU-2 P, P C 10 10 EUS, P C 10 10 EUS-UK110,**  
**P C 10 10 P L, P C 10 10 S, P C 10 10 UK1, P C 10 10 UK2**  
 den geltenden Gesundheits- und Sicherheitsanforderungen entspricht, so wie  
 sie in den folgenden Dokumenten festgehalten werden:  
**EN ISO 14121-1:2007, EN ISO 3744:1995, EN ISO 4871:2009,**  
**EN 1012-1:2010, EN 60204-1:2006+A1:2009, EN 286-1:1998**  
 Unterschriften von: Chris Klein  
 Position: Director of Engineering  
 Ort der Erklärung: Senco Brands, Inc.  
 4270 Ivy Pointe Blvd., Cincinnati, Ohio 45245  
 Ursprüngliche Herausgabe: 4. September 2014  
 Autorisierter Repräsentant:  
 (autorisiert, die technische Dokumentation zusammenzustellen)  
 Name: Peter van der Wel  
 Adresse: Senco Brands B.V.  
 Geurdeland 17E, 6673 DR Andelst, The Netherlands

**1. Senco Professional End User Warranty Policy**

Considering the following constraints Senco underwrites the reliability and the quality of its supplied authorised Senco branded products.

1.1 Senco warrants to the end user that the following products will be free from defects in construction, assembly and material for the warranty period specified below.

Product	Warranty period
Senco ® XP Series-Red Cap, pneumatic tools	Five years
Senco ® XP Series-Black Cap, pneumatic tools	Two years
Senco Pro Series, pneumatic tools	One year
Senco Semi-Pro Series, pneumatic tools	One year
Senco DuraSpin ® Series, electric and battery tools	One year
Senco Cordless battery tools	Two years
Senco batteries and chargers for tools	One year
Senco gas tools	Two years
Senco Reconditioned Products	One year
Senco other tools	One year
Senco Compressors	One year

1.2 The warranty period starts on the day the end user purchases the product and/or 1 year after the tool has been deleted from the product line, whichever date comes first.

1.3 To claim warranty the end user needs to send the defective products or their parts, including the serial number and the original and dated sales receipt or proof of purchase from the original retailer or dealer, freight prepaid to the original retailer or dealer.

1.4 Senco is not obliged to do any repairs or replacements on any products or their parts on site.

1.5 During the warranty period Senco or its distributors will repair or replace defective products or their parts, exclusively or mainly as a result of an imperfection in construction, assembly or material, at Senco's option and expense, subject to the constraints of this warranty policy.

1.6 The repair or replacement of products or their parts under warranty, does in no case lead to prolongation of the warranty period. For every replacement product or part, the remaining original warranty period of the replaced product or part is applicable.

1.7 Senco will become the owner of the products or parts that have been replaced by Senco or its distributors as a result of being compliant to Senco's warranty, without being obligated any compensation in this matter.

1.8 Excluded from the warranty are:

- Normal wear and tear parts, for example rubber o-rings, seals, driver blades, piston stops, piston/driver assemblies, isolators, drive belts, air filters and fuel systems, bits;
- Any imperfection that is a result of or has evolved from the fact that there has not been used clean, dry regulated compressed air and/or the air pressure applied has exceeded the maximum indicated on the tool casting (pneumatic tools);
- Any imperfection that is a result of or has evolved from normal wear, misapplication, abuse/misuse, improper modifications or storage, shipping/transport, accidents, neglect, operation at other than recommended speeds or voltage (electric units only);
- Any imperfection that is a result of or has evolved from explosions, fires and natural disasters, like hurricanes, floods and earthquakes;
- Any imperfection that is a result of or has evolved from not following operating instructions, specifications and / or maintenance schedules. Read the Operator Manual for use, specifications and maintenance instructions;
- Any imperfection that is caused by repairs, modifications to the product or attempts to do so by the end user or any third party;
- Labour charges or loss or damage resulting from improper operation, maintenance or repairs are not covered by this warranty
- Any warranty claims that have been received after the warranty period, as specified in this end user warranty, has expired.

1.9 Additional costs like shipping/transport, special packaging requirements and costs of travel and accommodation, are at the end users expense.

1.10 If a complaint is unfounded, all costs incurred thereby, including handling, inspection, shipping and administrative costs on the side of Senco or its distributors, will be charged to the end user.

1.11 After expiration of the warranty period, all costs for repair or replacement, including handling, inspection, shipping and administrative costs will be charged to the end user.

1.12 Notwithstanding legal limitation periods, the limitation of all claims and appeals against Senco and third parties involved by Senco for the implementation of the agreement is one year.

1.13 If Senco fails to meet this agreement, it will not discharge the end user from the obligations arising under this or any other contract.

1.14 When the warranty terms can not be met, due to for example import or export prohibitions, strikes or other unforeseen circumstances, the warranty period will be extended accordingly.

1.15 Senco's liability is limited to the warranty. Senco is not liable for damage caused by the functioning or non-functioning of the products as delivered, repaired or modified by Senco or its distributors, including but not limited to, production losses, profit losses, reduced working range, commercial losses or consequential damages or indirect damages whatsoever.

## Elektrischer Luftkompressor Teile Referenzhandbuch

NO:RLB-1409

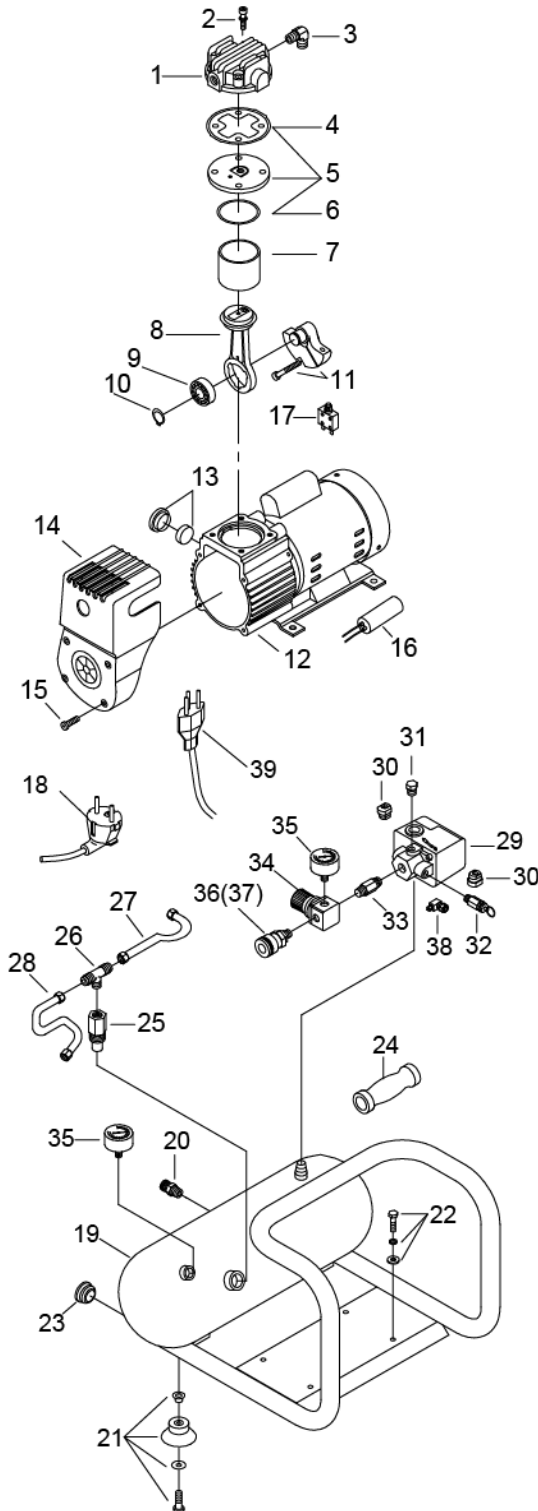

Ref. No.	Description	Part No.	Qty.
1	CYLINDER HEAD	3101063A	1
2	ALLEN BOLT SET	3B01-M05*060V	4
3	EXHAUST ELBOW	2N06-01T02H	1
4	CYLINDER HEAD GASKET	2G01-025H	1
5	EXHAUST VALVE ASSEMBLY	3B11-DC02A	1
6	VALVE SEAT GASKET	2G03-018	1
7	CYLINDER	3201068	1
8	ROD ASSEMBLY	3B3-MB02	1
9	BEARING	2N35-6201ZZC3	1
10	CLIP	2N42-S12	1
11	CRANKSHAFT & BALANCER	3304086	1
12	MOTOR SET	3B8-MB0206S	1
13	AIR FILTER SET	2140026RS	1
14	SHROUD	2428015RS	1
15	BOLT	2B02-FM4*015B	4
16	RUNNING CAPACITOR	2E27-004F4525	1
17	CIRCUIT BREAKER	2E25-01AS	1
18	POWER CABLE (2 PIN)	2E01-029S	1
19	AIR TANK	3401174U	1
20	DRAIN VALVE	2405012	1
21	RUBBER PAD SET	3433011-ARS	4
22	HEXAGON BOLT SET	3B00-FM06*012RS	4
23	PLUG	2N32-W07RS	2
24	GRIP	2432107	1
25	CHECK VALVE	2414033A	1
26	UNLOADING 3-WAY PIPE	2N09-02H01T02H4	1
27	UNLOADING TUBE	3B2-02*190F	1
28	DISCHARGE TUBE	2T02-02*0260RS	1
29	PRESSURE SWITCH	2E21-AA256BPS	1
30	STRAIN RELIEF BUSHING	2E04-008	2
31	PLUG	2N33-009	1
32	PRESSURE RELIEF VALVE	2406021A	1
33	NIPPLE	2N01-058RS	1
34	REGULATOR	2408008RRS	1
35	PRESSURE GAUGE	2D12-15D14BAR	2
36	QUICK COUPLER (FOR PC1010EU ONLY)	07S1/4M-ERS	1
37	QUICK COUPLER (FOR PC1010EU COMBO KIT, PC1010S, 6PR2001N)	07OS1/4M-C	1
38	UNLOADING VALVE	2409015	1
39	POWER CABLE (3 PIN)	2E01-044S	1



# Elektrische Luchtcompressor

## Gebruiksaanwijzing

(Vertaling Van De  
Oorspronkelijke  
Gebruiksaanwijzing)



# SENCO®

Senco Brands, Inc.  
4270 Ivy Pointe Blvd.  
Cincinnati, OH 45245  
1-800-543-4596  
www.senco.com  
EMEA: www.senco-emea.com



Waarschuwingen voor het veilige gebruik van deze compressor staan in deze handleiding vermeld.



Lees alle instructies en zorg dat u ze begrijpt.

PC1010 • Herziene 11 Maart 2015 (Vervangt 1/24/2013)

## Inhoudsopgave

Inleiding .....	3
Inspectie .....	3
Veiligheidswaarschuwingen .....	4
Compressorkenmerken .....	8
Vorbereiding .....	10
Eerste Instelling .....	10
Locatie .....	10
Elektriciteit .....	10
Bediening .....	11
Controlelijst Vóór Start .....	11
Opstarten .....	11
Uitschakelen .....	11
Onderhoud .....	11
Storingen Verhelpen .....	12
Specificaties .....	14
Conformiteitsverklaring .....	14
Beperkte Garantie .....	15
Parts Reference Guide .....	16

## Inleiding

Hartelijk gefeliciteerd met de aankoop van uw nieuwe SENCO®-luchtcompressor! U kunt er zeker van zijn dat uw SENCO-luchtcompressor met de grootst mogelijke precisie en nauwkeurigheid is geconstrueerd. Elk onderdeel is uitvoerig getest door technici om de kwaliteit, duurzaamheid en prestaties van deze luchtcompressor te kunnen waarborgen.

Deze gebruiksaanwijzing is voor uw gemak samengesteld. Door het lezen en opvolgen van de eenvoudige veiligheids-, installatie en bedienings- en onderhoudsstappen in deze handleiding kunt u jarenlang storingsvrij gebruik maken van uw nieuwe SENCO-luchtcompressor. De inhoud van deze handleiding is gebaseerd op de meest recente productinformatie ten tijde van de publicatie. De fabrikant behoudt zich het recht voor om zonder bericht vooraf op elk gewenst moment wijzigingen aan te brengen in prijs, kleur, materialen, apparatuur, specificaties of modellen.



### Veiligheidsattentie!

Een veiligheidsattentie "GEVAAR, WAARSCHUWING of LET OP" is altijd omgeven door een "VEILIGHEIDSATTENTIEKADER."

Dit kader wordt gebruikt om veiligheidswaarschuwingen aan te duiden en te benadrukken die moeten worden opgevolgd tijdens het gebruik van deze luchtcompressor. Deze veiligheidswaarschuwingen worden vergezeld van "signaalwoorden" die de mate of de ernst van het gevaar aangeven. De "signaalwoorden" die in deze handleiding worden gebruikt, zijn als volgt::

**Gevaar:** Geeft een dreigende, gevaarlijke situatie aan die, indien niet vermeden, ZAL resulteren in fataal of ernstig letsel.

**Waarschuwing:** Geeft een potentieel gevaarlijke situatie aan die, indien niet vermeden, KAN resulteren in fataal of ernstig letsel.

**Let Op:** Dit symbool duidt op een mogelijk gevaarlijke situatie die, indien de instructies niet worden opgevolgd, licht of matig letsel of schade aan de luchtcompressor tot gevolg kan hebben.



De symbolen die links van deze paragraaf staan, zijn de "Veiligheidsattentiesymbolen."

Deze symbolen worden gebruikt om de aandacht te vestigen op items of procedures die gevaarlijk kunnen zijn voor u of andere personen die deze apparatuur gebruiken.

**GEEF ALTIJD EEN EXEMPLAAR VAN DEZE HANDLEIDING AAN IEDEREEN DIE DEZE APPARATUUR GEBRUIKT. LEES ALLE AANWIJZINGEN IN DEZE HANDLEIDING EN EVENTUELE INSTRUCTIES DIE DOOR DE FABRIKANTEN VAN DE ONDERSTEUNENDE APPARATUUR WORDEN MEEGELEVERD, VOORDAT U DEZE LUCHTCOMPRESSOR GEBRUIKT EN WIJS MET NAME OP DE "VEILIGHEIDSWAARSCHUWINGEN" OM DE MOGELIJKHEID VAN PERSOONLIJK LETSEL VAN DE GEBRUIKER TE VOORKOMEN.**

## Inspectie

Pak de luchtcompressor uit en noteer het serienummer in de onderstaande ruimte. Controleer of er tekenen van zichtbare of verborgen transportschade zijn. Zorg ervoor dat alle beschadigde onderdelen vervangen worden en eventuele mechanische problemen worden gecorrigeerd voorafgaand aan het gebruik van de luchtcompressor.

**Serienummer** \_\_\_\_\_

Voor vragen of opmerkingen neemt u contact op met de gratis SENCO-actielijn: **1-800-543-4596** alleen VS of e-mail: [toolprof@senco.com](mailto:toolprof@senco.com)

Houd de volgende informatie gereed voor alle servicegesprekken:



1. Modelnummer
2. Serienummer
3. Datum en plaats van aankoop

Senco, 4270 Ivy Pointe Blvd., Cincinnati, OH 45245

## Veiligheidswaarschuwingen





**Lees Alle Veiligheidswaarschuwingen Voordat De Luchtcompressor Wordt Gebruikt**

Gevaar	Potentiële Gevolgen	Preventie
<p style="text-align: center;"><b>Risico Van Elektrische Schokken Of Elektrocutie</b></p> <div style="text-align: center;">      </div>	<ul style="list-style-type: none"> <li>• Wanneer de luchtcompressor niet juist geaard is, kan dit ernstig of fataal letsel tot gevolg hebben. Uw luchtcompressor wordt door elektriciteit gevoed en kan een elektrische schok of elektrocutie veroorzaken indien deze niet juist wordt gebruikt.</li> </ul>	<ul style="list-style-type: none"> <li>• Controleer of de luchtcompressor oeen stopcontact is aangesloten dat op de juiste wijze geaard is, en dat voorziet in de juiste spanning en voldoende beveiliging via een zekering.</li> </ul>
	<ul style="list-style-type: none"> <li>• Elektrische schokken kunnen worden veroorzaakt door het elektriciteits snoer.</li> </ul>	<ul style="list-style-type: none"> <li>• Controleer het netsnoer of dit niet beschadigd is door afknelling, scherpe voorwerpen of hitte. Vervang het defecte snoer voor gebruik.</li> <li>• Houd alle aansluitingen droog en vrran de grond. Voorkom dat de elektriciteits snoeren in water liggen of in een dusdanige positie dat watehiermee in contact kan komen. Raade stekker niet aan met natte handen.</li> <li>• Trek niet aan het elektriciteits snoer om dstekker uit het stopcontact te trekken.</li> </ul>
	<ul style="list-style-type: none"> <li>• Elektrische schokken kunnen worden veroorzaakt wanneer de luchtcompressor niet juist functioneert.</li> </ul>	<ul style="list-style-type: none"> <li>• Gebruik de luchtcompressor nooit in vochtige omstandigheden of buitenshuis wanneer het regent.</li> <li>• Gebruik de luchtcompressor nooit wanneer veiligheidskappen/afdichtingen verwijderd of beschadigd zijn.</li> </ul>
	<ul style="list-style-type: none"> <li>• Ernstig of fataal letsel kan plaatsvinden wanneer elektrische reparaties uitgevoerd zijn door niet-gekwalificeerd personeel.</li> </ul>	<ul style="list-style-type: none"> <li>• Eventuele elektrische bedradingswerkzaamheden of reparaties aan deze luchtcompressor moet worden uitgevoerd door geautoriseerd onderhoudspersoneel conform de landelijke regionale elektriciteitsnormen.</li> <li>• Voordat een compartiment met elektrische onderdelen wordt geopend, altijd de luchtcompressor uitschakelen, ddruk verlagen en de stekker van luchtcompressor uit het stopcontact verwijderen. Laat de luchtcompressor afkoelen. Ga er nooit vanuit dat het veilig is om aan de luchtcompressor te werken omdat deze niet ingeschakeld is. Deze kan elk moment inschakelen!</li> </ul>

## Veiligheidswaarschuwingen





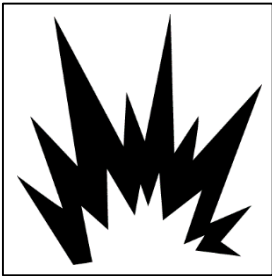

**Lees Alle Veiligheidswaarschuwingen Voordat De Luchtcompressor Wordt Gebruikt**

Gevaar	Potentiële Gevolgen	Preventie
<p style="text-align: center;"><b>Risico Van Explosie Of Brand</b></p> <div style="text-align: center;">    </div>	<ul style="list-style-type: none"> <li>• Ernstig of fataal letsel kan veroorzaakt worden door normale elektrische vonken in de motor en de drukschakelaar.</li> <li>• Ernstig letsel kan worden veroorzaakt wanneer de ventilatieopeningen in de luchtcompressor geblokkeerd zijn, waardoor de luchtcompressor oververhit raakt en vlam kan vatten.</li> </ul>	<ul style="list-style-type: none"> <li>• Gebruik een luchtcompressor altijd in een goed geventileerde ruimte vrij van ontvlambare dampen, explosief stof, gas of andere explosieve materialen.</li> <li>• Wanneer ontvlambare materialen worden gespoten, plaats de luchtcompressor dan tenminste 6 meter verwijderd van het spuitgebied (Wellicht is een extra slang noodzakelijk.)</li> <li>• Plaats nooit voorwerpen tegen of op de luchtcompressor. Plaats de luchtcompressor voor gebruik altijd minimaal 30 cm van muren of hindernissen die de juiste ventilatie kunnen beperken.</li> </ul>
<p style="text-align: center;"><b>Risico Van Barsten</b></p> <div style="text-align: center;">  </div>	<ul style="list-style-type: none"> <li>• Ernstig of fataal letsel kan worden veroorzaakt door een explosie van de luchttanks wanneer luchttanks niet correct onderhouden zijn.</li> <li>• Ernstig of fataal letsel kan worden veroorzaakt door een storing in de luchtcompressor of exploderende accessoires wanneer onjuiste systeemonderdelen, randapparaten of accessoires worden gebruikt.</li> </ul>	<ul style="list-style-type: none"> <li>• Tap de luchttank dagelijks af of na gebruik om vochtophoping in de luchttank te voorkomen.</li> <li>• Als de luchttank gaat lekken, dient u de luchttank nooit te vervangen. Probeer de luchttank nooit te repareren of te lassen probeer de luchttank en diens randapparaten nooit aan te passen.</li> <li>• Verander nooit de fabrieksinstelwaarden voor de druk.</li> <li>• Overschrijdt nooit de door de fabrikant aangegeven maximum toegestane drukwaarden voor de randapparaten.</li> <li>• Gebruik vanwege de extreme hitte nooit kunststof pijpen of met tin gesoldeerde koppelingen voor een afvoerleiding.</li> <li>• Gebruik de luchtcompressor nooit om kleine voorwerpen met een lage druk zoals speelgoed, op te pompen.</li> <li>• Alle slangen en hulpstukken zullen geschikt zijn voor plaatsgebruik aan het maximaal toelaatbare werkingsdruk van de draagbare compressor.</li> <li>• Gebruik uitsluitend originele Senco reserveonderdelen als u uw perspomp wilt repareren.</li> </ul>

## Veiligheidswaarschuwingen

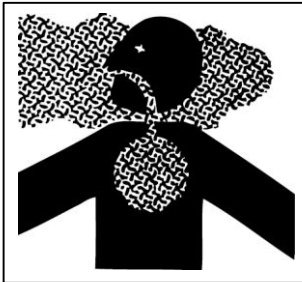



**Lees Alle Veiligheidswaarschuwingen Voordat De Luchtcompressor Wordt Gebruikt**

Gevaar	Potentiële Gevolgen	Preventie
<p style="text-align: center;"><b>Risico Voor Ademhaling</b></p> 	<ul style="list-style-type: none"> <li>• Het inhaleren van perslucht kan ernstig of fataal letsel tot gevolg hebben. De luchtstroom kan koolmonoxide, giftige dampen of vaste deeltjes bevatten.</li> <li>• Spuitmaterialen, zoals verf/lak, verfverduunners, verfverwijderaars, insecticiden, onkruidbestrijdingsmiddelen, enz. bevatten schadelijke dampen en giften.</li> </ul>	<ul style="list-style-type: none"> <li>• Adem nooit lucht in van de luchtcompressor dat rechtstreeks of via een ademapparaat dat op de luchtcompressor is aangesloten, wordt aangevoerd.</li> <li>• Gebruik de luchtcompressor alleen in een goed geventileerde ruimte. Volg alle veiligheidsaanwijzingen die bij de materialen worden geleverd die u gaat spuiten. Bij het gebruik van sommige materialen is het dragen van een ademhalingsapparaat noodzakelijk.</li> </ul>
<p style="text-align: center;"><b>Risico Van Brandwonden</b></p> 	<ul style="list-style-type: none"> <li>• Het aanraken van blootliggende metalen onderdelen kan ernstig letsel veroorzaken. Deze delen kunnen lange tijd heet blijven na uitschakeling van de luchtcompressor.</li> </ul>	<ul style="list-style-type: none"> <li>• Voorkom dat lichaamsdelen of andere materialen in contact komen met blootliggende metalen delen vade luchtcompressor, onderdelen voor motor en leidingen.</li> </ul>
<p style="text-align: center;"><b>Risico Van Rondvliegende Voorwerpen</b></p> 	<ul style="list-style-type: none"> <li>• Zacht weefsel kan beschadigd worden door de persluchtstroom.</li> </ul>	<ul style="list-style-type: none"> <li>• Draag altijd een veiligheidsbril die voldoet aan de van toepassing zijndArbo-normen om de ogen tegen rondvliegend vuil te beschermen.</li> <li>• Richt de luchtstroom nooit op lichaamsdelen, andere personen of dieren.</li> <li>• Laat een luchtcompressor onder druk nooit zonder toezicht. Schakel de luchtcompressor uit en verlaag ddruk voordat onderhoud wordt uitgevoerd of gereedschappen of accessoires worden aangesloten.</li> </ul>
<p style="text-align: center;"><b>Draag Altijd Oogbescherming</b></p> 	<ul style="list-style-type: none"> <li>• Los vuil dat met hoge snelheid door de persluchtstroom wordt weggeslingerd, kan ernstig letsel veroorzaken.</li> </ul>	<ul style="list-style-type: none"> <li>• Zorg altijd voor een veilige afstand tot mensen en dieren wanneer de luchtcompressor wordt gebruikt.</li> <li>• Verplaats de luchtcompressor niet wanneer de lucht tank onder druk staat. Probeer de luchtcompressor niet te verplaatsen door aan de slang te trekken</li> </ul>

## Veiligheidswaarschuwingen

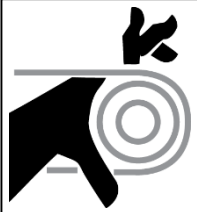

Lees Alle Veiligheidswaarschuwingen Voordat De Luchtcompressor Wordt Gebruikt

Gevaar	Potentiële Gevolgen	Preventie
<p style="text-align: center;"><b>Risico Van Bewegende Onderdelen</b></p>  <p style="text-align: center;"><b>Pas Op: Apparaat Kan Zomaar Starten</b></p> 	<ul style="list-style-type: none"> <li>• Risico van lichamelijk letsel door bewegende onderdelen. Deze luchtcompressor schakelt automatisch in wanneer de drukschakelaar in de stand <b>ON (1)</b>/Auto staat.</li> </ul>	<ul style="list-style-type: none"> <li>• Schakel de luchtcompressor altijd wanneer deze niet wordt gebruikt. Verlaag de druk in de luchtslang en trek de stekker uit het stopcontact voordat u onderhoud gaat uitvoeren. Alle reparaties aan de luchtcompressor moeten worden uitgevoerd door geautoriseerd onderhoudspersoneel. Ga er nooit vanuit dat het veilig is om aan de luchtcompressor te werken omdat deze niet in bedrijf is. Deze kan elk moment inschakelen!</li> <li>• Niet gebruiken zonder veiligheidsafdichtingen/kappen. Vervang beschadigde afdichtingen/kappen voordat de luchtcompressor wordt gebruikt.</li> </ul>
<p style="text-align: center;"><b>Risico Van Nalatigheid</b></p> 	<ul style="list-style-type: none"> <li>• Risico van letsel door nalatig gebruik.</li> </ul>	<ul style="list-style-type: none"> <li>• Laat kinderen of jongeren nooit de luchtcompressor bedienen!</li> <li>• Blijf alert - let op wat u doet. Gebruik de luchtcompressor niet wanneer u moe bent of onder invloed van alcohol of medicijnen.</li> <li>• Weet hoe u de luchtcompressor moet stoppen. Zorg dat u voldoende vertrouwd bent met de besturingselementen.</li> </ul>
<p style="text-align: center;"><b>Risico Van Luchtcompressor Schade</b></p>	<ul style="list-style-type: none"> <li>• Risico van grote reparatie.</li> </ul>	<ul style="list-style-type: none"> <li>• Gebruik de luchtcompressor niet zonder een luchtfilter.</li> <li>• Gebruik de luchtcompressor niet in een corrosieve omgeving.</li> <li>• Gebruik de luchtcompressor altijd in een stabiele, veilige positie om te voorkomen dat de luchtcompressor omvalt.</li> <li>• Volg alle onderhoudsinstructies die in deze handleiding vermeld staan.</li> </ul>

**! BEWAAR DEZE INSTRUCTIES !**

## Compressorkenmerken

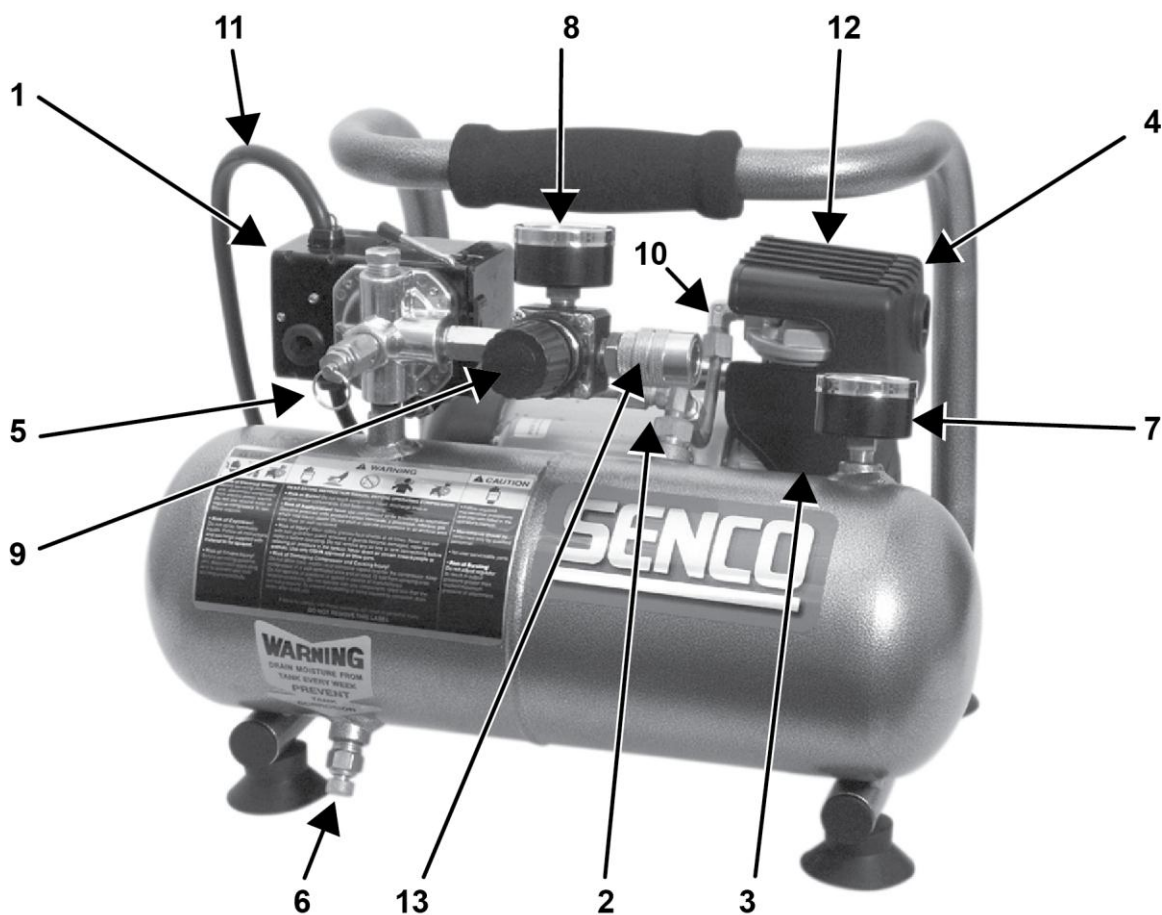

1.	Motor/drukschakelaar
2.	Thermische overbelasting / Reset
3.	Luchtinlaatfilter
4.	Luchtcompressorpomp
5.	Veiligheidsontlastingsklep
6.	Aftapklep luchttank
7.	Tankdrukmeter
8.	Uitlaatdrukmeter
9.	Drukregelaar
10.	Afvoerleiding
11.	Netsnoer, 230 volt
12.	Ventilatie-openingen / Beschermingsversterking
13.	Snelkoppeling



## Compressorkenmerken

**1) Motor/Drukschakelaar:** Deze schakelaar wordt gebruikt om de luchtcompressor te starten en te stoppen. Door de schakelaar in de stand **ON (1)** te plaatsen, wordt er automatisch spanning naar de drukschakelaar gevoerd waarmee de motor kan worden gestart wanneer de druk in de luchttank daalt tot beneden de fabrieksmatig ingestelde inschakeldruk. In de stand **ON (1)** stopt de drukschakelaar de motor wanneer de druk in de luchttank de fabrieksmatig ingestelde uitschakeldruk bereikt. Als veiligheidsvoorziening beschikt deze schakelaar ook over een drukregelklep die zich aan de zijde van de schakelaar bevindt en die ontworpen is om automatisch de perslucht af te laten uit de pompkop van de luchtcompressor en diens afvoerleiding wanneer de luchtcompressor de uitschakeldruk bereikt of wordt uitgeschakeld. Hierdoor kan de motor normaal opnieuw starten. Door de schakelaar in de stand **OFF (0)** te plaatsen, wordt de spanning naar de drukschakelaar onderbroken en stopt de luchtcompressor.

**2) Overbelasting Van De Motor:** De motor heeft een veiligheidsvoorziening op de pomp. Als er overmatig veel stroom op staat wordt alles uitgeschakeld, ter bescherming van de motor en degene die hem bedient. Deze veiligheidsschakelaar kan opnieuw worden ingeschakeld door de zwarte plastic knop in te drukken. Doe dit als deze omhoog is gekomen.

**3) Luchtinlaatfilter:** Dit filter is ontworpen om de instromende lucht in de pomp te reinigen. Om ervoor te zorgen dat de pomp continu wordt voorzien van schone, koele, droge aanvoer van lucht, moet dit filter altijd schoon zijn en de ventilatie-openingen vrij van obstakels. Het filter kan worden verwijderd voor reiniging in een warm sopje. Spoel het filter en laat het aan de lucht drogen.

**4) Luchtcompressorpomp:** Om de lucht samen te persen, beweegt de zuiger omhoog en omlaag in de cilinder. Tijdens de slag omlaag wordt de lucht via de luchtinlaatklep naar binnen gezogen terwijl de uitlaatklep gesloten blijft. Tijdens de slag omhoog wordt de lucht samengeperst, de inlaatklep wordt gesloten en perslucht wordt naar buiten geperst via de uitlaatklep, in de afvoerleiding, via de keerklep in de luchttank.

**5) Veiligheidsontlastingsklep:** Deze klep is ontwikkeld om systeemstoringen te voorkomen door de druk in het systeem te verlagen wanneer de perslucht een vooraf ingesteld niveau bereikt. De klep is vooraf ingesteld door de fabrikant en mag op geen enkele wijze worden aangepast. Om de juiste werking van de klep te controleren, trekt u aan de ring. De perslucht moet ontsnappen. Wanneer de ring wordt losgelaten, sluit de klep weer.

**6) Aftapklep Luchttank:** De aftapklep wordt gebruikt om vocht uit de luchttank(s) te verwijderen nadat de luchtcompressor uitgeschakeld is. **Probeer NOOIT de aftapklep te openen wanneer de luchtdruk in de luchttank 0.7 bar of meer is!** Om de aftapklep te openen, draait u de knop linksom. Kantel de tank om er zeker van te zijn dat alle condensatie via de klep wordt afgetapt.

**7) Luchttankdrukmeter:** De luchttankdrukmeter geeft de reserveluchtdruk in de luchttank(s) aan.

**8) Uitlaatdrukmeter:** De uitlaatdrukmeter geeft de luchtdruk aan die beschikbaar is aan de uitlaatzijde van de drukregelaar. Deze druk wordt geregeld door de drukregelaar en is altijd minder of gelijk aan de luchttankdruk.

**9) Drukregelaar:** De luchtdruk van de luchttank wordt geregeld met de regelknop. Draai de drukregelaarknop rechtsom om de uitlaatdruk te vergroten en linksom om de uitlaatdruk te verkleinen. Volg de aanwijzingen om het apparaat te gebruiken, met de aanbevolen minimale en maximale druk.

**10) Afvoerleiding:** Let op: de afvoerleiding is zeer heet. **HEET! Verwijder de bescherming niet. Hoge temperaturen na langdurig gebruik.**

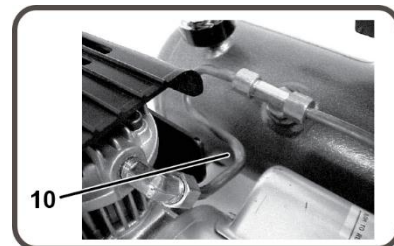
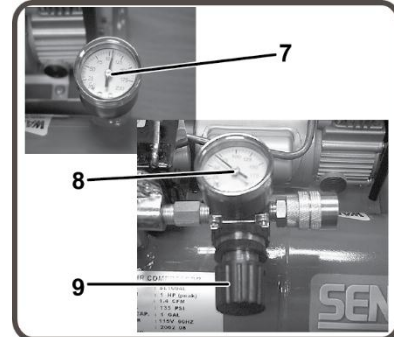
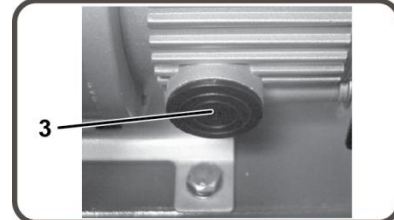
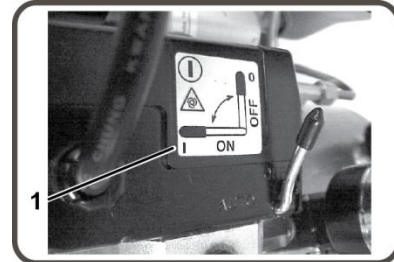

## Vorbereiding

### Eerste Instelling

1. Lees de veiligheidswaarschuwingen voordat u de luchtcompressor instelt.

### Locatie

**Let Op** Om schade aan de luchtcompressor te voorkomen, mag de luchtcompressor niet meer dan 10 overdwers of in de lengte worden gekanteld.

1. Plaats de luchtcompressor minimaal 30 cm van hindernissen die de juiste ventilatie kunnen verhinderen.

Plaats de luchtcompressor niet in een van de volgende ruimten:

- Waar aanwijzingen zijn voor olie- of gaslekken.
- Waar brandbare gasdampen of materialen aanwezig kunnen zijn.

### Waarschuwing



Ernstig of fataal letsel kan worden veroorzaakt wanneer elektrische vonken van motor en drukschakelaar in contact komen met brandbare dampen, explosief stof, gassen of andere explosieve materialen. Wanneer de luchtcompressor wordt gebruikt voor het spuiten van lak, plaats de luchtcompressor dan zo ver mogelijk verwijderd van het werkgebied als mogelijk is, zo nodig met behulp van extra luchtslangen in plaats van verlengsnoeren.

- Waar de luchttemperatuur lager is dan 0C of hoger is dan 40C.
- Waar zeer vuile lucht of water in de luchtcompressor kan worden gezogen.

### Elektriciteit

### GEVAAR



Onjuiste aansluiting van de aardingsaansluiting van de apparatuur kan resulteren in risico van schokken of elektrocutie. Neem contact op met een gekwalificeerde elektromonteur of onderhoudspersoneel wanneer u twijfelt of het stopcontact wel juist geaard is. Gebruik geen enkel type adapter met dit product. Wanneer reparatie of vervanging van het snoer of de stekker noodzakelijk is, sluit de aardingsdraad dan niet aan op een van de twee stekkerpennen. De draad met de groen/geel gestreepte of groene isolatie is de aardingsdraad.

### Waarschuwing



Dit product moet worden geaard. Wanneer er een storing of een defect is, biedt de aarding een verbinding met de minste weerstand voor de elektrische stroom om het risico van een elektrische schok te verkleinen. Dit product is voorzien van een snoer dat voorzien is van een stekker met randaarde. De stekker moet in een geschikt stopcontact worden aangesloten dat op de juiste wijze geïnstalleerd en geaard is conform de plaatselijke voorschriften en richtlijnen.

1. SENCO® RAADT HET GEBRUIK VAN VERLENGSNOEREN AF omdat deze spanningsverlies en oververhitting van de motor kunnen veroorzaken. Het gebruik van een extra luchtslang heeft de voorkeur boven een verlengsnoer. Wanneer het gebruik van een verlengsnoer onvermijdelijk is, moet deze worden aangesloten op een stroomkring met aardlekschakelaar (in de zekeringenkast) of een stopcontact met randaarde.

Bij gebruik van een verlengsnoer, dient u het volgende in acht te nemen:

<u>Kabellengte</u>	<u>Draaddoorsnede</u>
Tot 7,5 meters	2,05 mm
Tot 30 meters	2,59 mm
Tot 50 meters	3,26 mm
Tot 75 meters	4,11 mm

Gebruik alleen verlengsnoeren waarvan de elektrische belasting tenminste gelijk is aan die van het product. Gebruik geen beschadigde verlengsnoeren. Controleer het verlengsnoer voor gebruik en vervang het indien het beschadigd is. Mishandel een verlengsnoer niet en trek niet aan snoeren om stekkers uit stopcontacten te verwijderen. Houd het snoer uit de buurt van hitte en scherpe randen. Zet de schakelaar van de luchtcompressor altijd in de uit-stand voordat u de stekker uit het stopcontact verwijderd.

## Bediening

### Controlelijst Vóór Start

1. Verwijder eventueel vocht uit de luchttank van de luchtcompressor. Verwijder overtollige druk met een persluchtgereedschap, open vervolgens de aftapklep van de luchttank aan de onderzijde van de luchttank. Laat overmatige druk ontsnappen door te trekken aan het veiligheidsventiel, of met een ventileergereedschap. Open daarna pas het afvoerventiel aan de onderkant van de tank. Na aftappen stevig sluiten.



**Waarschuwing:: Risico van lichamelijk letsel. Probeer NOOIT de aftapklep te openen wanneer de luchtdruk in de luchttank 0.7 bar of meer is!!**

2. Zorg ervoor dat motorschakelaar van de luchtcompressor in de stand **OFF (0)** staat.
3. Controleer of alle veiligheidskleppen juist werken.
4. Controleer of alle veiligheidskappen en -afdichtingen aanwezig zijn en stevig vastzitten.

### Opstarten

1. Controleer of de schakelhendel op de drukschakelaarkast in de stand **OFF (0)** staat.
2. Steek de stekker van het netsnoer in een geaard stopcontact.
3. Plaats de schakelhendel op de drukschakelaarkast in de stand **ON (1)**.
4. Met **Start** kan de luchtcompressor de druk in de luchttanks verhogen en met **Stop** wordt het verhogen van de druk gestopt wanneer het juiste drukniveau bereikt is. Wanneer de druk tijdens het gebruik daalt, zal de luchtcompressor met **Start** de druk opnieuw verhogen.
5. Stel de druk in door de drukregelaarknop linksom te draaien voor een lagere druk en rechtsom voor een hogere druk.
6. Wanneer u ongebruikelijke geluiden hoort of trillingen voelt, stopt u de luchtcompressor en raadpleegt u "Storingen Verhelpen."

### Uitschakelen

1. Om de luchtcompressor te stoppen, plaatst u de schakelhendel van de drukschakelaarkast in de stand **OFF (0)**. Stop de luchtcompressor NOOIT door de stekker ervan uit het stopcontact te trekken. Dit kan resulteren in risico van elektrocutie.
2. Laat de lucht af van de luchttank door lucht met een aangesloten persluchtapparaat af te blazen of door aan de ring van de veiligheidsontlastingsklep te trekken.
3. Zodra de druk in de luchttanks gedaald is tot minder dan 0.7 bar, opent u de aftapklep onder elke luchttank om eventueel vocht af te tappen.
4. Laat de luchtcompressor afkoelen.
5. Veeg luchtcompressor schoon en berg het apparaat op in een veilige, vorstvrije ruimte.

## Onderhoud

Lees de gebruiksaanwijzing voordat u onderhoud gaat uitvoeren. De onderstaande procedures moeten worden uitgevoerd wanneer de luchtcompressor wordt gestopt voor onderhoud of service.

1. Schakel de luchtcompressor uit.



**Waarschuwing: Ga er nooit vanuit dat het veilig is om aan de luchtcompressor te werken omdat deze niet in bedrijf is. Deze kan elk moment inschakelen!**

2. Trek de stekker van het netsnoer uit het stopcontact.
3. Open alle aftapkleppen.
4. Wacht tot de luchtcompressor afgekoeld is, voordat u aan de service begint.

Onderhoudsoverzicht			
Procedure	Dagelijks	Wekelijks	Maandelijks
Condensatie van luchttank(s) aftappen	X		
Ongebruikelijke geluiden/trillingen controleren	X		
Luchtlekkages controleren	X		
Luchtfilter inspecteren		X	
Buitenkant van de compressor schoonmaken		X	
Veiligheidsontlastingsklep controleren			X

## Storingen Verhelpen

### Symptoom 1. Motor draait niet of kan niet opnieuw worden gestart.

Mogelijke Oorzaak	Remedie
<ul style="list-style-type: none"> <li>• Stekker van netsnoer niet in het stopcontact.</li> </ul>	<ul style="list-style-type: none"> <li>• Steek de stekker van het netsnoer in een geaard stopcontact.</li> </ul>
<ul style="list-style-type: none"> <li>• Motor/drukschakelaar in stand <b>OFF (0)</b>.</li> </ul>	<ul style="list-style-type: none"> <li>• Zet de schakelaar in de stand <b>ON (1)</b>.</li> </ul>
<ul style="list-style-type: none"> <li>• Thermische overbelastingsschakelaar van de motor geactiveerd.</li> </ul>	<ul style="list-style-type: none"> <li>• Schakel de luchtcompressor uit, wacht tot de motor is afgekoeld, controleer vervolgens de stroomonderbreker van de motor.</li> </ul>
<ul style="list-style-type: none"> <li>• Zekering gesmolten of aardlekschakelaar geactiveerd.</li> </ul>	<ul style="list-style-type: none"> <li>• Vervang de zekering of schakel de stroomonderbreker weer in. Controleer de juiste stroomsterkte van de zekering. Controleer of de spanning te laag is. Schakel eventuele andere elektrische apparaten binnen de stroomkring uit, of sluit de luchtcompressor aan op diens eigen stroomkring.</li> </ul>
<ul style="list-style-type: none"> <li>• Verkeerde draaddoorsnede of verkeerde lengte verlengsnoer.</li> </ul>	<ul style="list-style-type: none"> <li>• Controleer het overzicht op pagina 10 voor de juiste draaddoorsnede en snoerlengte.</li> </ul>
<ul style="list-style-type: none"> <li>• Druk luchttank groter dan "inschakel"-druk motor/drukschakelaar.</li> </ul>	<ul style="list-style-type: none"> <li>• Motor start automatisch, wanneer de druk in de luchttank daalt tot beneden de "inschakel"-druk van de motor/drukschakelaar.</li> </ul>
<ul style="list-style-type: none"> <li>• Drukregelklep op de motor/drukschakelaar heeft de druk in de pompkop niet verlaagd.</li> </ul>	<ul style="list-style-type: none"> <li>• Ontlucht de leiding door de schakelaar in de stand <b>OFF (0)</b> te plaatsen.</li> </ul>
<ul style="list-style-type: none"> <li>• Defecte motor, motorcondensator, motor/drukschakelaar of ontlastingsklep.</li> </ul>	<ul style="list-style-type: none"> <li>• Neem contact op met de klantenservice van Senco.</li> </ul>

### Symptoom 2. In de stand Start/Stop draait de motor continu.

Mogelijke Oorzaak	Remedie
<ul style="list-style-type: none"> <li>• Motor/drukschakelaar schakelt de motor niet uit wanneer de luchtcompressor de "uitschakel"-druk bereikt en veiligheidsontlastingsklep wordt ingeschakeld.</li> </ul>	<ul style="list-style-type: none"> <li>• Zet de motor/drukschakelaar in de stand <b>OFF (0)</b>. Wanneer de motor niet uitschakelt, trekt u de stekker van de luchtcompressor uit het stopcontact. Wanneer de elektrische contactpunten aan elkaar gesmolten zijn, vervangt u de drukschakelaar.</li> </ul>
<ul style="list-style-type: none"> <li>• Het vermogen van de luchtcompressor is niet juist berekend.</li> </ul>	<ul style="list-style-type: none"> <li>• Beperk de luchtdruk tot de capaciteit van de luchtcompressor. Gebruik een kleiner persluchtapparaat of een grotere luchtcompressor.</li> </ul>

### Symptoom 3. Lucht blijft lekken bij de regelklep van de motor/drukschakelaar nadat de motor gestopt is.

Mogelijke Oorzaak	Remedie
<ul style="list-style-type: none"> <li>• De ontlastingsklep klemt in de geopende stand</li> </ul>	<ul style="list-style-type: none"> <li>• Verwijderen, schoonmaken of vervangen</li> </ul>

### Symptoom 4. Lucht blijft lekken bij de regelklep van de motor/drukschakelaar terwijl de motor draait.

Mogelijke Oorzaak	Remedie
<ul style="list-style-type: none"> <li>• Defecte motor/drukschakelaar</li> </ul>	<ul style="list-style-type: none"> <li>• Vervangen</li> </ul>

### Symptoom 5. Lucht lekt bij de veiligheidsontlastingsklep.

Mogelijke Oorzaak	Remedie
<ul style="list-style-type: none"> <li>• Mogelijk defecte veiligheidsontlastingsklep.</li> </ul>	<ul style="list-style-type: none"> <li>• Bedien de veiligheidsontlastingsklep handmatig door aan de ring te trekken.</li> </ul>
<ul style="list-style-type: none"> <li>• Te hoge druk in de luchttank.</li> </ul>	<ul style="list-style-type: none"> <li>• Wanneer de klep nog steeds lekt, moet deze worden vervangen. Defecte motor/drukschakelaar. Vervangen.</li> </ul>

## Storingen Verhelpen

### Symptoom 6. Lucht lekt bij de fittingen.

Mogelijke Oorzaak	Remedie
<ul style="list-style-type: none"> <li>Fittingen zijn niet vast genoeg aangedraaid</li> </ul>	<ul style="list-style-type: none"> <li>Haal de fittingen aan waar hoorbaar is dat er lucht ontsnapt. Controleer de fittingen met een sopje. Draai ze niet te vast</li> </ul>

### Symptoom 7. Luchtlek in de luchttank.

Mogelijke Oorzaak	Remedie
<ul style="list-style-type: none"> <li>Defecte of roestende luchttank</li> </ul>	<ul style="list-style-type: none"> <li>Luchttank moet worden vervangen. Probeer een luchttank niet te repareren! Niet lassen, repareren of modificeren</li> </ul>

### Symptoom 8. Lucht ontsnapt via inlaatfilter.

Mogelijke Oorzaak	Remedie
<ul style="list-style-type: none"> <li>Beschadigde inlaatklep.</li> </ul>	<ul style="list-style-type: none"> <li>Neem contact op met de klantenservice van Senco.</li> </ul>

### Symptom 9: For lavt trykk på luftverktøy eller tilbehør.

Mogelijke Oorzaak	Remedie
<ul style="list-style-type: none"> <li>Drukregelaarknop niet ingesteld op een druk die hoog genoeg is, of een defecte drukregelaar.</li> </ul>	<ul style="list-style-type: none"> <li>Stel de drukregelaarknop in op de juiste instelling of vervang deze.</li> </ul>
<ul style="list-style-type: none"> <li>Verstopt luchtinlaatfilter.</li> </ul>	<ul style="list-style-type: none"> <li>Schoonmaken.</li> </ul>
<ul style="list-style-type: none"> <li>Lucht lekt.</li> </ul>	<ul style="list-style-type: none"> <li>Controleer op lekken en repareer.</li> </ul>
<ul style="list-style-type: none"> <li>Luchtcompressor niet groot genoeg voor vereiste luchtdruk.</li> </ul>	<ul style="list-style-type: none"> <li>Controleer de vereiste luchtdruk voor de accessoire. Wanneer deze hoger is dan het debiet (m<sup>3</sup>/min) of de geleverde luchtdruk van de luchtcompressor, dan heeft u een grotere luchtcompressor nodig.</li> </ul>

### Symptoom 10. Luchtcompressor genereert onvoldoende luchtdruk.

Mogelijke Oorzaak	Remedie
<ul style="list-style-type: none"> <li>Verstopt luchtinlaatfilter.</li> </ul>	<ul style="list-style-type: none"> <li>Schoonmaken.</li> </ul>
<ul style="list-style-type: none"> <li>Defecte (reed)klep.</li> </ul>	<ul style="list-style-type: none"> <li>Tap de luchttank af en meet de pomptijd. Vergelijk deze met de specificaties. Indien lager, dient u de pompkop te verwijderen en de klepplaat te controleren, reinigen of te vervangen.</li> </ul>

### Symptoom 11. Vocht in uitlaatlucht.

Mogelijke Oorzaak	Remedie
<ul style="list-style-type: none"> <li>Condensatie in de luchttank veroorzaakt door een hoge luchtvochtigheid of luchtcompressor heeft niet lang genoeg gedraaid</li> </ul>	<ul style="list-style-type: none"> <li>Tap luchttank na elk gebruik af. Tap luchttank vaker af bij vochtig weer en gebruik een filter in de luchtleiding.</li> </ul>

## Specificaties

Modell-Nr.: PC 1010		
<b>Motor</b>	Vermogen (pk)	0.5 pk (piek) 0.3 KW
	Spanning	230V
	Stroomsterkte	2A
	Hz.	50
	Fase	Enkelvoudig
	TPM	2850
<b>Compressorpompe</b>	Aantal cilinders	1
	Compressiefase	1
	Carter	Aluminium
	Lagers	Kogel
	Cilinder	Aluminium
	Kleppen	Enkelvoudige reedklep
	Kop	Aluminium
	Filter	Invoegen
<b>Instelling Motor/Drukschakelaar</b>	Uitschakeldruk	8.6 bar (125 PSI)
	Inschakeldruk	6.6 bar (95 PSI)
	Bedieningselementen	ON (1) / OFF (0)
<b>Luchttank</b>	Inhoud	3.8 Liter (1 Gallon)
<b>Prestaties</b>	L/Min Luchtverplaatsing	32 (1.1 CFM)
	L/Min @ 2.8 bar	17 (0.6 CFM @ 40 PSI)
	L/Min @ 6.2 bar	10 (0.35 CFM @ 90 PSI)
	L/Min @ 6.9 bar	9 (0.31 CFM @ 100 PSI)
	Maximumdruk	8.6 bar (125 PSIG)
	Pomptijd: 0-9 bar	160 seconden
	Hersteltijd: 7-9 bar	48 seconden
<b>Gewicht</b>	Netto	9.1 kg
<b>Afmetingen</b>	Basis L x B x H	48.5 x 30 x 31 cm
<b>Noise</b>	Measured sound power level (dB)	78 dBA
	Guaranteed sound power level (dB)	81 dBA

## Conformiteitsverklaring

Wij Senco Brands, Inc.  
 uit 4270 Ivy Pointe Blvd., Cincinnati, Ohio 45245  
 in overeenstemming met de volgende richtlijn(en):  
**Machinerichtlijn 2006/42/EC**  
**Pressure Vessel Directive 2009/105/EC.**  
**EMC Directive 2004/108/EC**  
**Low Voltage Directive 2006/95/EC**  
**RoHS Directive 2011/65/EU**  
**Noise Emission Directive 2005/88/EC**  
 verklaren onder onze eigen verantwoordelijkheid dat: Model(len):  
**PC 1010 EU, PC 1010EU-2P, PC 1010EUS, PC 1010EUS-UK110,**  
**PC 1010PL, PC 1010S, PC 1010UK1, PC 1010UK2**  
 in overeenstemming is met de toepasselijke essentiële gezondheids-en  
 veiligheidseisen van de volgende documenten:  
**EN ISO 14121-1:2007, EN ISO 3744:1995, EN ISO 4871:2009,**  
**EN1012-1:2010, EN 60204-1:2006+A1:2009, EN286-1:1998**  
 Ondertekend door: Chris Klein  
 Functie: Engineeringdirecteur  
 Locatie van doc.: Senco Brands, Inc.  
 4270 Ivy Pointe Blvd., Cincinnati, Ohio 45245  
 Originale uitgave: 4 September 2014  
 Geautoriseerde vertegenwoordiger:  
 (gemaakt om het technisch dossier samen te stellen)  
 Naam: Peter van der Wel  
 Adres: Senco Brands B.V.  
 Geurdeland 17E, 6673 DR Andelst, The Netherlands

**1. Senco Professional End User Warranty Policy**

Considering the following constraints Senco underwrites the reliability and the quality of its supplied authorised Senco branded products.

1.1 Senco warrants to the end user that the following products will be free from defects in construction, assembly and material for the warranty period specified below.

Product	Warranty period
Senco ® XP Series-Red Cap, pneumatic tools	Five years
Senco ® XP Series-Black Cap, pneumatic tools	Two years
Senco Pro Series, pneumatic tools	One year
Senco Semi-Pro Series, pneumatic tools	One year
Senco DuraSpin ® Series, electric and battery tools	One year
Senco Cordless battery tools	Two years
Senco batteries and chargers for tools	One year
Senco gas tools	Two years
Senco Reconditioned Products	One year
Senco other tools	One year
Senco Compressors	One year

1.2 The warranty period starts on the day the end user purchases the product and/or 1 year after the tool has been deleted from the product line, which ever date comes first.

1.3 To claim warranty the end user needs to send the defective products or their parts, including the serial number and the original and dated sales receipt or proof of purchase from the original retailer or dealer, freight prepaid to the original retailer or dealer.

1.4 Senco is not obliged to do any repairs or replacements on any products or their parts on site.

1.5 During the warranty period Senco or its distributors will repair or replace defective products or their parts, exclusively or mainly as a result of an imperfection in construction, assembly or material, at Senco's option and expense, subject to the constraints of this warranty policy.

1.6 The repair or replacement of products or their parts under warranty, does in no case lead to prolongation of the warranty period. For every replacement product or part, the remaining original warranty period of the replaced product or part is applicable.

1.7 Senco will become the owner of the products or parts that have been replaced by Senco or its distributors as a result of being compliant to Senco's warranty, without being obligated any compensation in this matter.

1.8 Excluded from the warranty are:

- Normal wear and tear parts, for example rubber o-rings, seals, driver blades, piston stops, piston/driver assemblies, isolators, drive belts, air filters and fuel systems, bits;
- Any imperfection that is a result of or has evolved from the fact that there has not been used clean, dry regulated compressed air and/or the air pressure applied has exceeded the maximum indicated on the tool casting (pneumatic tools);
- Any imperfection that is a result of or has evolved from normal wear, misapplication, abuse/misuse, improper modifications or storage, shipping/transport, accidents, neglect, operation at other than recommended speeds or voltage (electric units only);
- Any imperfection that is a result of or has evolved from explosions, fires and natural disasters, like hurricanes, floods and earthquakes;
- Any imperfection that is a result of or has evolved from not following operating instructions, specifications and / or maintenance schedules. Read the Operator Manual for use, specifications and maintenance instructions;
- Any imperfection that is caused by repairs, modifications to the product or attempts to do so by the end user or any third party;
- Labour charges or loss or damage resulting from improper operation, maintenance or repairs are not covered by this warranty
- Any warranty claims that have been received after the warranty period, as specified in this end user warranty, has expired.

1.9 Additional costs like shipping/transport, special packaging requirements and costs of travel and accommodation, are at the end users expense.

1.10 If a complaint is unfounded, all costs incurred thereby, including handling, inspection, shipping and administrative costs on the side of Senco or its distributors, will be charged to the end user.

1.11 After expiration of the warranty period, all costs for repair or replacement, including handling, inspection, shipping and administrative costs will be charged to the end user.

1.12 Notwithstanding legal limitation periods, the limitation of all claims and appeals against Senco and third parties involved by Senco for the implementation of the agreement is one year.

1.13 If Senco fails to meet this agreement, it will not discharge the end user from the obligations arising under this or any other contract.

1.14 When the warranty terms can not be met, due to for example import or export prohibitions, strikes or other unforeseen circumstances, the warranty period will be extended accordingly.

1.15 Senco's liability is limited to the warranty. Senco is not liable for damage caused by the functioning or non-functioning of the products as delivered, repaired or modified by Senco or its distributors, including but not limited to, production losses, profit losses, reduced working range, commercial losses or consequential damages or indirect damages whatsoever.

## Elektrische Luchtcompressor

### Parts Reference Guide

NO:RLB-1409

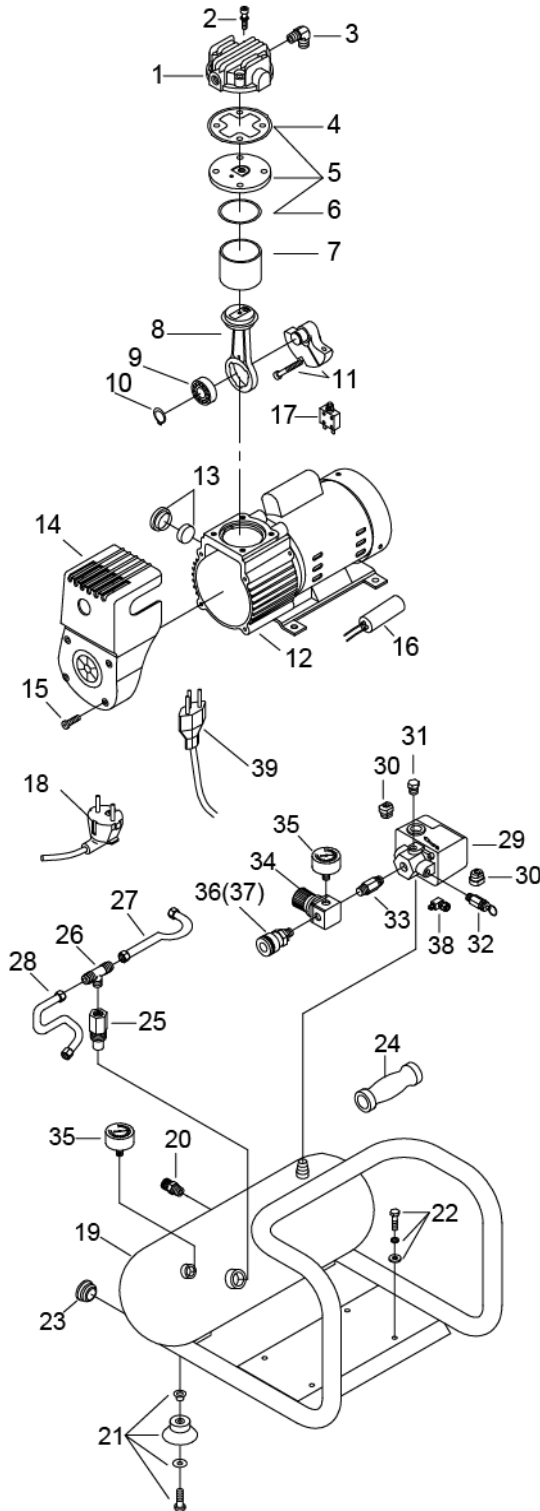

Ref. No.	Description	Part No.	Qty.
1	CYLINDER HEAD	3101063A	1
2	ALLEN BOLT SET	3B01-M05*060V	4
3	EXHAUST ELBOW	2N06-01T02H	1
4	CYLINDER HEAD GASKET	2G01-025H	1
5	EXHAUST VALVE ASSEMBLY	3B11-DC02A	1
6	VALVE SEAT GASKET	2G03-018	1
7	CYLINDER	3201068	1
8	ROD ASSEMBLY	3B3-MB02	1
9	BEARING	2N35-6201ZZC3	1
10	CLIP	2N42-S12	1
11	CRANKSHAFT & BALANCER	3304086	1
12	MOTOR SET	3B8-MB0206S	1
13	AIR FILTER SET	2140026RS	1
14	SHROUD	2428015RS	1
15	BOLT	2B02-FM4*015B	4
16	RUNNING CAPACITOR	2E27-004F4525	1
17	CIRCUIT BREAKER	2E25-01AS	1
18	POWER CABLE (2 PIN)	2E01-029S	1
19	AIR TANK	3401174U	1
20	DRAIN VALVE	2405012	1
21	RUBBER PAD SET	3433011-ARS	4
22	HEXAGON BOLT SET	3B00-FM06*012RS	4
23	PLUG	2N32-W07RS	2
24	GRIP	2432107	1
25	CHECK VALVE	2414033A	1
26	UNLOADING 3-WAY PIPE	2N09-02H01T02H4	1
27	UNLOADING TUBE	3B2-02*190F	1
28	DISCHARGE TUBE	2T02-02*0260RS	1
29	PRESSURE SWITCH	2E21-AA256BPS	1
30	STRAIN RELIEF BUSHING	2E04-008	2
31	PLUG	2N33-009	1
32	PRESSURE RELIEF VALVE	2406021A	1
33	NIPPLE	2N01-058RS	1
34	REGULATOR	2408008RRS	1
35	PRESSURE GAUGE	2D12-15D14BAR	2
36	QUICK COUPLER (FOR PC1010EU ONLY)	07S1/4M-ERS	1
37	QUICK COUPLER (FOR PC1010EU COMBO KIT, PC1010S, 6PR2001N)	07OS1/4M-C	1
38	UNLOADING VALVE	2409015	1
39	POWER CABLE (3 PIN)	2E01-044S	1



# Electric Air Kompressorori

## Käyttöohjeet

(Alkuperäisten Ohjeiden Käännös)



# SENCO®

Senco Brands, Inc.  
4270 Ivy Pointe Blvd.  
Cincinnati, OH 45245  
1-800-543-4596  
www.senco.com  
EMEA: www.senco-emea.com



Tämä käyttöopas sisältää kompressorin turvallista käyttöä koskevia varoituksia.



Lue ja ymmärrä kaikki ohjeet.

PC1010 • Tarkistettu 11 Maaliskuu 2015 (Korvaa 1/24/2013)

## Sisällysluettelo

Johdanto.....	3
Tarkastus.....	3
Turvavaroitukset.....	4
Kompressorin Ominaisuudet.....	8
Alkuvalmistelut .....	10
Ensimmäinen Käyttöönotto.....	10
Sijainti .....	10
Sähkö.....	10
Käyttö .....	11
Tehtävä Ennen Käynnistystä.....	11
Käynnistys .....	11
Sammutus.....	11
Huolto .....	11
Vianetsintä.....	12
Tekniset Tiedot.....	14
Vaatimustenmukaisuusvakuutus .....	14
Rajoitettu Takuu .....	15
Parts Reference Guide.....	16

## Johdanto

Onnittelut uuden SENCO®-paineilmakompressorin hankinnasta! Voit luottaa siihen, että SENCO-paineilmakompressorin on valmistettu tarkasti ja virheettömästi. Kukin osa on läpäissyt tiukan teknisen testin, jolla varmistetaan tämän paineilmakompressorin laatu, kestävyys ja suorituskyky.

Tämä käyttäjän opas on laadittu huolella sinua varten. Kun luet ja noudatat oppaassa kuvattuja yksinkertaisia turvallisuus-, asennus-, käyttö- ja huolto-ohjeita, voit käyttää uutta SENCO-paineilmakompressoriasi huoletta vuosien ajan. Tämä ohjekirja on tehty julkaisuajankohdasta saatavilla olleiden tuoreimpien tuotetietojen perusteella. Valmistaja varaa itselleen oikeuden muuttaa hintaa, värejä, valmistusaineita, varusteita, teknisiä yksityiskohtia tai malleja milloin tahansa ilman ennakoilmoitusta.



### Turvallisuusvaroitukset

”VAARA-, VAROITUS- tai HUOMIO-” turvavaroitusten ympärillä on ”VAROITUSKEHYKSET.”

Näillä kehyksillä merkitään ja korostetaan turvavaroituksia, joita täytyy noudattaa tätä paineilmakompressorin käytettäessä. Turvavaroitusten yhteydessä käytetään ”tunnussanoja”, jotka osoittavat vaaran vakavuuden. Tässä käyttöoppassa käytetään seuraavia ”tunnussanoja”:

**VAARA:** Tarkoittaa välittömästi vaarallista tilannetta, joka johtaa **VARMASTI** kuolemaan tai vakavaan vammaan, jos sitä ei voida välttää.

**VAROITUS:** Tarkoittaa mahdollisesti vaarallista tilannetta, joka **SAATTAA** johtaa kuolemaan tai vakavaan vammaan, jos sitä ei voida välttää.

**HUOMIO:** Tarkoittaa mahdollisesti vaarallista tilannetta, joka **SAATTAA** johtaa lievään vammaan tai paineilmakompressorin rikkoutumiseen, jos sitä ei vältetä.



Tämän kappaleen vasemmalla puolella olevat symbolit ovat ”varoitus symboleja”. Näillä symboleilla merkitään esineitä tai toimenpiteitä, jotka voivat olla vaarallisia laitteen käyttäjälle.

**ANNA AINA LAITTEEN KÄYTTÄJÄLLE TÄMÄ KÄYTTÖOHJE. LUE KOKONAISUUDESSAAN TÄMÄ KÄYTTÖOHJE SEKÄ MAHDOLLISET LISÄLAITTEIDEN KÄYTTÖOHJEET, ENNEN KUIN KÄYTÄT TÄTÄ PAINEILMAKOMPRESSORIA JA KIINNITÄ ERITYISTÄ HUOMIOTA ”TURVAVAROITUKSIIN”, JOTTA KÄYTTÄJÄN MAHDOLLINEN LOUKKAANTUMINEN VOIDAAN VÄLTÄÄ.**

## Tarkastus

Ota paineilmakompressorin ulos laatikosta ja kirjoita sen sarjanumero alla olevaan tilaan. Tutki, onko laite vaurioitunut kuljetuksen aikana. Älä käytä paineilmakompressorin ennen kuin kaikki vaurioituneet osat on korvattu uusilla ja mekaaniset viat on korjattu.

**SARJANUMERO** \_\_\_\_\_

Jos sinulla on kysymyksiä tai kommentoitavaa, soita SENCO:n palvelunumeroon: **1-800-543-4596** tai kirjoita sähköpostiviesti: [toolprof@Senco.com](mailto:toolprof@Senco.com)

Seuraavia tietoja kysytään, kun soitat huoltoon liittyvissä asioissa:



1. Mallin numero
2. Sarjanumero
3. Ostopaikka ja -päivämäärä

Senco, 4270 Ivy Pointe Blvd., Cincinnati, OH 45245

## Turvavaroitukset





Lue Kaikki Varoitukset Ennen Kuin Käytät  
Paineilmakompressoria

Vaara	Mahdolliset Seuraukset	Ehkäisy
<p style="text-align: center;"><b>Vammauttavan Tai Kuolettavan Sähköiskun Vaara</b></p> <div style="text-align: center;">      </div>	<ul style="list-style-type: none"> <li>• Vakava vamma tai kuolema, jos paineilmakompressoria ei ole maadoitettu oikein. Paineilmakompressori toimii sähköllä ja saattaa aiheuttaa sähköiskun, jos sitä ei käytetä oikein.</li> <li>• Sähköiskun voi saada sähköjohdosta.</li> <li>• Sähköisku on mahdollinen, jos kompressoria käytetään väärin.</li> <li>• Epäpätevän henkilön tekemät sähkölaitteen huoltotyöt voivat johtaa vakavaan vammaan tai kuolemaan.</li> </ul>	<ul style="list-style-type: none"> <li>• Varmista, että kompressori on kytketty maadoitettuun pistorasiaan, jonka jännite on oikea ja sulakkeet riittävät.</li> <li>• Tarkista, että virtajohto ei ole murskautunut, katkennut tai sulanut. Vaihda viallinen johto ennen käyttöä.</li> <li>• Pidä kaikki kytkennät kuivina ja irti maasta. Älä anna sähköjohtojen lojua vedessä tai paikassa, jossa ne saattavat kastua. Älä kosketa pistoketta, kun kätesi ovat märät.</li> <li>• Irrota johto virtalähteestä vetämällä pistokkeesta, ei johdosta.</li> <li>• Älä käytä kompressoria kosteissa tiloissa tai ulkona sateella.</li> <li>• Älä käytä kompressoria, jos suojukset/kannet eivät ole paikoillaan tai ne ovat vioittuneet. Lain mukaan vain pätevä huoltohenkilö saa korjata tai huoltaa tätä paineilmakompressoria.</li> <li>• Aina ennen sähkökotelon avaamistasammuta paineilmakompressori, vapauta paine ja irrota kompressori virtalähteestä. Anna kompressorin jäähtyä. Älä milloinkaan oleta, että oturvallista avata kompressori vain, koska se ei ole käynnissä. Se saattaa käynnistyä uudestaan minä hetkenä tahansa!</li> </ul>

## Turvavaroitukset







### Lue Kaikki Varoitukset Ennen Kuin Käytät Paineilmakompressoria

Vaara	Mahdolliset Seuraukset	Ehkäisy
<p><b>Räjähdyks- Tai Tulipalovaara</b></p>  	<ul style="list-style-type: none"> <li>• Moottorista ja painekykimestä lähtevät kipinät saattaavat aiheuttaa vakavia vammoja tai kuoleman.</li> <li>• Vakava vamma on mahdollinen, jos kompressorin ilmanvaihtoaukko tukkiintuu, jolloin kompressori ylikuumenee ja syttyy palamaan.</li> </ul>	<ul style="list-style-type: none"> <li>• Käytä paineilmakompressoria vain tiloissa, joissa on hyvä ilmanvaihto, kaukana tulenaroista höyryistä, palavista pölyistä, kaasuista tai muista palonaroista materiaaleista.</li> <li>• Jos ruiskutat palonarkaa ainetta, sijoita paineilmakompressori vähintään kuuden metrin päähän ruiskutusalueesta (pidempi letku saattaa olla tarpeen).</li> <li>• Älä jätä tavaroita kompressorin päälle tai nojaamaan sitä vasten. Käytä kompressoria vähintään 30 cm etäisyydellä seinästä tai muusta rakenteesta, joka saattaisi rajoittaa ilmanvaihtoa.</li> </ul>
<p><b>Räjähdyksvaara</b></p> 	<ul style="list-style-type: none"> <li>• Ilmasäiliön räjähtäminen voi aiheuttaa vakavia vammoja tai kuoleman, jos säiliötä ei huolleta oikein.</li> <li>• Kompressorin toimintahäiriö tai räjähtävät lisälaitteet voivat aiheuttaa vakavia vammoja, jos käytetään vääränlaisia lisäosia.</li> </ul>	<ul style="list-style-type: none"> <li>• Tyhjennä ilmasäiliö päivittäin tai jokaisen käytön jälkeen, jotta säiliöön ei kertyisi kosteutta.</li> <li>• Jos ilmasäiliö alkaa vuotaa, vaihda se välittömästi. Älä yritä korjata, hitsata tai muunnella ilmasäiliötä tai siihen liittyviä osia.</li> <li>• Älä muuta paineen oletusasetuksia.</li> <li>• Älä ylitä lisäosien valmistajan määrittelemiä maksimipaineasetuksia.</li> <li>• Älä käytä poistoputkessa muovisia tai tinajuotettuja liitoskappaleita kuumuuden takia.</li> <li>• Älä käytä paineilmakompressoria pienille esineille, kuten ilman pumppaamiseen leluihin.</li> <li>• Käytä kompressorissasi yksinomaan alkuperäisiä SENCO-varaosia.</li> </ul>

## Turvavaroitukset



**Lue Kaikki Varoitukset Ennen Kuin Käytät Paineilmakompressoria**

Vaara	Mahdolliset Seuraukset	Ehkäisy
<p><b>Vaarallista Hengittää</b></p> 	<ul style="list-style-type: none"> <li>Paineilman hengittäminen voi aiheuttaa vakavia vammoja tai kuoleman. Ilmavirta voi sisältää hääkää, myrkyllisiä höyryjä tai hiukkasia.</li> </ul>	<ul style="list-style-type: none"> <li>Älä hengitä paineilmakompressorist tulevaa ilmaa suoraan tai siihen kytketyn hengityslaitteen kautta.</li> <li>Käytä paineilmakompressoria vain tiloissa, joissa on hyvä ilmanvaihto. Noudata ruiskuttamiesi aineiden turvaohjeita. Kaasunaamarin käyttö saattaa olla pakollista joitakin aineita käsiteltäessä.</li> </ul>
<p><b>Palovamman Vaara</b></p> 	<ul style="list-style-type: none"> <li>Ruiskutetut aineet, kuten maalit, liuotteet, maalin poistoaineet, hyönteismyrkyt, rikkaruohojen torjunta-aineet jne. sisältävät haitallisia höyryjä ja myrkyä.</li> </ul>	<ul style="list-style-type: none"> <li>Älä anna minkään kehon osan tai esineiden koskettaa paineilmakompressorin metalliosia, moottorin tai putkiston.</li> </ul>
<p><b>Lentävien Esineiden Vaara</b></p> 	<ul style="list-style-type: none"> <li>Metalliosien koskettaminen voi aiheuttaa vakavia vammoja. Nämä alueet voivat olla kuumia senkin jälkeen, kun kompressori on sammutettu.</li> </ul>	<ul style="list-style-type: none"> <li>Suojaa aina silmäsi lentäviltä roskiltä käyttämällä työsuojeluehdot täyttävä ”Z87”-suojalaseja.</li> <li>Älä osoita ilmasuihkulla itseäsi, muihimisiä tai eläimiä.</li> <li>Älä jätä paineistettua paineilmakompressoria valvomatta. Sammuta laite ja vapauta paine ennen kuin huollat sitä tai kiinnität siihen välineitä tai lisäosia.</li> <li>Pidä ihmiset ja eläimet turvallisella etäisyydellä, kun käytät paineilmakompressoria.</li> </ul>
<p><b>Käytä Aina Suojalaseja</b></p> 	<ul style="list-style-type: none"> <li>Paineilmasuihku voi aiheuttaa pehmeiden kudosten vaurioitumista. Paineilmasuihkun mukana lentävät irtoroskat voivat aiheuttaa vakavia vammoja.</li> </ul>	<ul style="list-style-type: none"> <li>Älä siirrä paineilmakompressoria, kun sen ilmasäiliö on paineistettu. Älä yritä siirtää paineilmakompressoria vetämällä sitä letkusta.</li> </ul>

## Turvavaroitukset



Lue Kaikki Varoitukset Ennen Kuin Käytät  
Paineilmakompressoria

Vaara	Mahdolliset Seuraukset	Ehkäisy
<p style="text-align: center;"><b>Huolimattomuudesta Aiheutuva Vaara</b></p> <div style="text-align: center;"> </div> <p style="text-align: center;"><b>Variotus: Laite Voi Käynnistyä Varoittamatta</b></p> <div style="text-align: center;"> </div>	<ul style="list-style-type: none"> <li>• Liikkuvat osat voivat aiheuttaa ruumiinvamman. Tämä paineilmakompressori toimii automaattisesti, kun painekeytkin on <b>ON (1)</b>/Auto-asennossa.</li> </ul>	<ul style="list-style-type: none"> <li>• Sammuta kompressori aina, kun lopetat sen käytön. Laske paine ulos ilmaletkusta ja irrota laite virtalähteestä ennen huoltotoimenpiteitä. Vain pätevä huoltohenkilö saa korjata kompressorin. Älä milloinkaan oletta, että on turvallista avata kompressori vain, koska se ei ole käynnissä. Se saattaa käynnistyä uudestaan minä hetkenä tahansa!</li> <li>• Älä käytä laitetta ilman suojakantta tai suojuksia. Vaihda vialliset suojakannet tai suojuukset ennen käyttöä.</li> </ul>
<p style="text-align: center;"><b>Kompressorin Vaurioitumisriski</b></p> <div style="text-align: center;"> </div>	<ul style="list-style-type: none"> <li>• Huolimattomasta käytöstä johtuva vammautumiseriski.</li> </ul>	<ul style="list-style-type: none"> <li>• Älä anna lasten tai nuorten käyttää tätä paineilmakompressoria!</li> <li>• Pysy valppaana - keskity siihen, mitteet. Älä käytä paineilmakompressoria, jos olet väsynyt tai alkoholin tai huumaavien lääkkeiden vaikutuksen alaisena.</li> <li>• Opettele sammuttamaan paineilmakompressori. Tutustu perusteellisesti ohjauslaitteisiin.</li> </ul>
<p style="text-align: center;"><b>Liikkuvien Osien Aiheuttama Vaara</b></p>	<ul style="list-style-type: none"> <li>• Vakavan vaurioitumisen riski.</li> </ul>	<ul style="list-style-type: none"> <li>• Älä käytä paineilmakompressoria ilman ilmansuodatinta.</li> <li>• Älä käytä paineilmakompressoria syöpymistä aiheuttavassa ympäristössä.</li> <li>• Käytä paineilmakompressoria vain, kun se on tukevasti vakaassa asennossa, jotta se ei kaatuisi.</li> <li>• Noudata kaikkia tässä oppaassa mainittuja huolto-ohjeita.</li> </ul>

**! SÄILYTÄ NÄMÄ OHJEET!**

## Kompressorin Ominaisuudet

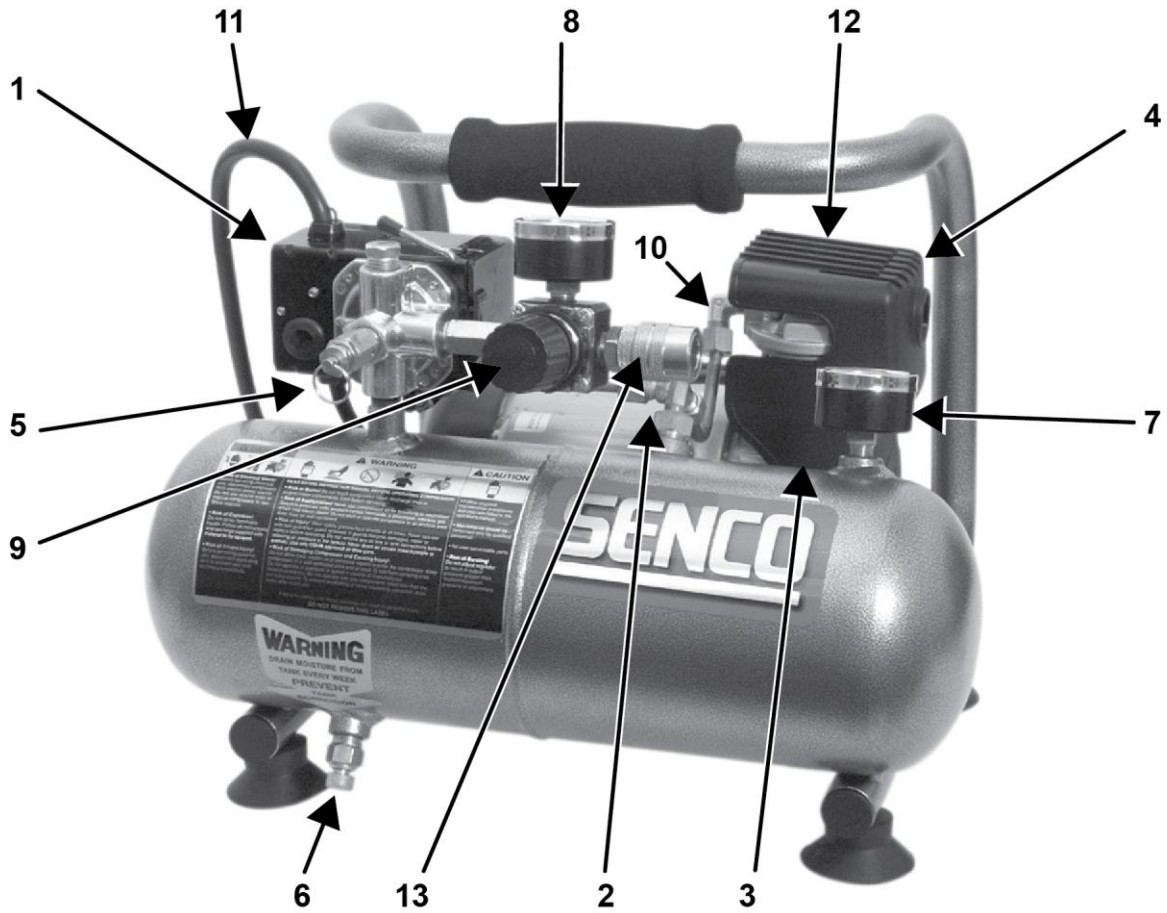

1.	Moottori-/painekeytkin
2.	Yliämpökytkin / Palautus
3.	Sisäänottoilman suodatin
4.	Paineilmakompressorin pumppu
5.	Varoventtiili
6.	Ilmasäiliön tyhjennysventtiili
7.	Ilmasäiliön painemittari
8.	Lähtöpaineen mittari
9.	Paineensäädin
10.	Poistoputki
11.	Sähköjohto
12.	Ilmanvaihtoaukot / Suojus
13.	Pikairrotus



## Compressor

**1) Moottori-/Painekytin:** Tätä kytkintä käytetään paineilmakompressorin käynnistämiseen ja pysäyttämiseen. Kun kytkin käännetään **ON (1)**-asentoon, painekytin saa automaattisesti virtaa, minkä ansiosta moottori voi käynnistyä, kun ilmasäiliön paine on alempi kuin tehtaalla asetettu ala-arvo. **ON (1)**-valinnassa painekytin pysäyttää moottorin, kun ilmasäiliön paine nousee tehtaalla asetettuun yläarvoon. Turvallisuussyistä tämän kytkimen sivussa on myös ylipaineventtiili, joka on suunniteltu vapauttamaan paineistettu ilma automaattisesti kompressorin pumpun päästä ja sen päästöventtiilistä, kun kompressorin paine nousee yläarvoon tai laite sammutetaan. Tämän ansiosta moottori voi vapaasti käynnistyä uudelleen. Kun kytkin käännetään **OFF (0)**-asentoon, painekytin ei saa virtaa ja kompressorin sammuu.

**2) Moottorin Ylikuormitus:** Moottorissa on suojakatkaisin, joka sijaitsee pumpulla. Liiallisen virrankulutuksen seurauksena katkaisin laukeaa suojatakseen moottoria ja käyttäjää. Palauta katkaisin painamalla musta muovikahva takaisin koteloon. Palauta katkaisin, jos se on lauennut.

**3) Sisäänottoilman Suodatin:** Tämä ilmansuodatin puhdistaa pumppuun menevän ilman. Jotta pumppuun pääsee jatkuvasti puhdasta, viileää ja kuivaa ilmaa, tämän suodattimen täytyy aina olla puhdas ja ilmanvaihtoaukon esteetön. Ilmansuodattimen voi irrottaa ja sen voi puhdistaa lämpimällä saippuavedellä. Huuhto suodatin ja anna sen kuivua.

**4) Paineilmakompressorin Pumppu:** Mäntä liikkuu ylös alas sylinterissä ja puristaa ilmaa kokoon. Kun se menee alaspäin, ilmaa tulee sisään ilmanottoventtiilin kautta ja poistoventtiili pysyy kiinni. Kun mäntä menee ylöspäin, ilma paineistuu, ilmanottoventtiili menee kiinni, ja paineistettu ilma puristuu ulos poistoventtiilin kautta, poistoputkeen, sulkuventtiilin läpi ja ilmasäiliöön.

**5) Varoventtiili:** Tämän venttiilin tarkoitus on estää laitteen vioittuminen vapauttamalla painetta laitteesta, kun ilmanpaine nousee tietylle tasolle. Valmistaja on säätänyt venttiilin oikein, eikä sitä saa muuttaa millään tavalla. Voit tarkistaa venttiilin toiminnan vetämällä renkaasta. Paineistettua ilmaa pitäisi päästä ulos. Kun renkaasta päästetään irti, venttiili palaa istukkaan.

**6) Ilmasäiliön Tyhjennysventtiili:** Tyhjennysventtiiliä käytetään kosteuden poistamiseen ilmasäiliö(i)stä, sen jälkeen kun paineilmakompressorin on sammutettu. **ÄLÄ yritä avata tyhjennysventtiiliä, kun ilmasäiliössä on yli 0.7 bar paine!**

Tyhjennysventtiili avataan kääntämällä nuppia vastapäivään. Kallista säiliötä niin, että kaikki kosteus valuu venttiilistä ulos.

**7) Ilmasäiliön Painemittari:** Ilmasäiliön painemittari näyttää, kuinka paljon ilmanpainetta ilmasäiliö(i)ssä on jäljellä.

**8) Lähtöpaineen Mittari:** Lähtöpaineen mittari näyttää säätimen ulostulopuolella olevan ilmanpaineen. Tätä painetta säädetään säätimellä ja se on aina enintään sama kuin ilmasäiliön paine.

**9) Paineensäädin:** Ilmasäiliöstä tulevaa ilmanpainetta säädellään paineensäätimellä. Poistuspainetta kasvatetaan kääntämällä nuppia myötöpäivään ja pienennetään kääntämällä sitä vastapäivään. Noudata työkalun käyttöohjeissa annettuja painealue-suosituksia.

**10) Poistoputki:** Huom! Poistoputki on todella kuuma.

**Kuumia pintoja-Älä poista suojaa. Korkea lämpötila kovassa käytössä.**

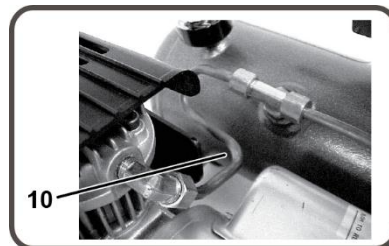
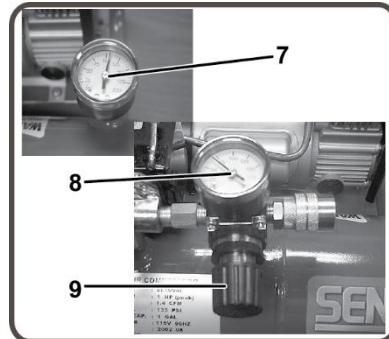
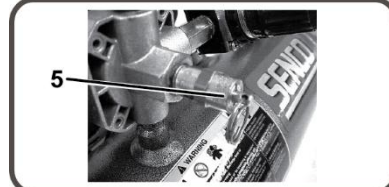
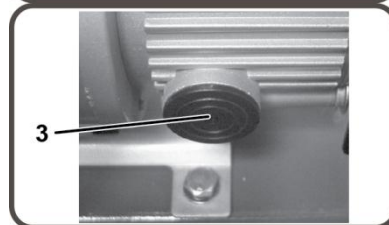
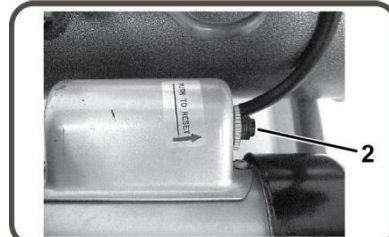
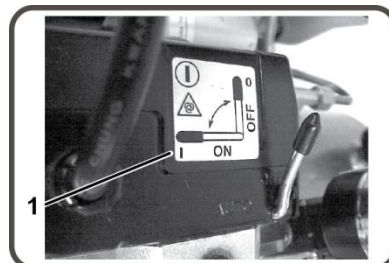

### Ensimmäinen Käyttöönotto

1. Lue turvavaroitukset ennen kuin otat paineilmakompressorin käyttöön.

### Sijainti

**Huomio** Jotta paineilmakompressorin ei vahingoittuisi, älä kallista sitä poikittain tai pitkittäin yli 10 kulmaan.

1. Sijoita paineilmakompressorin vähintään 30 cm etäisyydelle esineistä, jotka saattavat häiritä ilmanvaihtoa.

Älä laita paineilmakompressorin paikkaan:

- Jossa on öljy- tai kaasuvuotoja.
- Jossa voi olla palonarkoja kaasuja tai materiaaleja.

**Varoitus**  Jos moottori- ja paineitykimistä lähtevät kipinät joutuvat kosketuksiin palonarkojen höyryjen, palavien tomujen, kaasujen tai muiden palonarkojen materiaalien kanssa, seurauksena voi olla vakavia vammoja tai kuolema. Kun käytät paineilmakompressorin ruiskumaalaukseen, sijoita paineilmakompressorin mahdollisimman etäälle työskentelyalueelta ja käytä pidempää ilmaletkua jatkojohdon sijasta.

- Jossa ilman lämpötila on alle 0C (32 F) tai yli 40C (104 F).
- Jossa hyvin likaista vettä tai ilmaa voi joutua paineilmakompressorin sisään.

### Sähkö

**Vaara**  Laitteen maadoittavan johdon virheellinen kytkentä voi johtaa vammauttavan tai kuolettavan sähköiskun vaaraan. Jos et ole varma, onko käyttämäsi pistorasia kunnolla maadoitettu, pyydä sähköasentajaa tai pätevää huoltohenkilöä tarkistamaan asia. Älä käytä mitä tahansa välikappaletta tämän tuotteen kanssa. Jos johto tai pistoke täytyy korjata tai vaihtaa, älä kytke maadoitusjohtoa kumpaankaan litteäsiipinapaan. Maadoitusjohdon tunnistaa eristeestä, jonka ulkopuoli on vihreä, ja siinä voi olla keltaisia juovia.

**Varoitus**  Tämä tuote täytyy maadoittaa. Jos laitteeseen tulee toimintahäiriö tai se menee epäkuntoon, maadoitus tarjoaa sähkövirralle pienimmän vastuksen reitin, mikä pienentää sähköiskun vaaraa. Tässä tuotteessa on sähköjohto, jossa on laitteen maadoittava johdin ja maadoituspistoke. Pistoke pitää kytkeä pistorasiaan, joka on asennettu ja maadoitettu kaikkien määräysten mukaisesti.

1. SENCO® EI SUOSITTELE JATKOJOHTOJEN KÄYTTÄMISTÄ, sillä niiden käyttö voi aiheuttaa tehohäviötä ja moottorin ylikuumentumista. Ylimääräisen ilmaletkun käyttö on suositeltavampaa kuin jatkojohdon käyttö. Jos jatkojohdon käyttö on välttämätöntä, se pitää kytkeä kytkentärasiaan olevaan maavuotokatkaisimeen (GFCI) tai koteloituun pistorasiaan.

Kun käytät jatkojohtoa, ota seuraavat asiat huomioon:

<u>Johdon pituus</u>	<u>Johdon paksuus</u>
7,5 m saakka	12 AWG
30 m saakka	10 AWG
45 m saakka	8 AWG
75 m saakka	6 AWG

Käytä vain jatkojohtoja, joiden nimellisteho on vähintään sama kuin tuotteen nimellisteho. Älä käytä viallisia jatkojohtoja. Tutki jatkojohto ennen käyttöä ja vaihda se tarvittaessa uuteen. Älä pahoinpitele jatkojohtoa äläkä kisko mitään johtoa irti pistorasiasta. Pidä johto kaukana kuumasta ja terävistä reunoista. Sammuta paineilmakompressorin aina kytkimestä ennen pistokkeen irrottamista pistorasiasta.

## Käyttö

### Tehtävä Ennen Käynnistystä

1. Poista kosteus paineilmakompressorin ilmasäiliöstä. Vapauta ylimääräinen paine ilmaustyökalulla ja avaa ilmasäiliön alaosassa oleva tyhjennysventtiili. Poista liika paine vetämällä ylipaineventtiilin rengasta tai käyttämällä paineilmatyökalua, ja avaa sitten ilmasäiliön tyhjennysventtiili ilmasäiliön pohjassa. Sulje tiukasti tyhjennyksen jälkeen.



**Varoitus: Kehon vamman vaara. ÄLÄ yritä avata tyhjennysventtiiliä, kun ilmasäiliössä on yli 0.7 bar ilmanpaine!**

2. Varmista, että paineilmakompressorin moottorikytkin on **OFF (0)**-asennossa.
3. Varmista, että kaikki varoventtiilit toimivat kunnolla.
4. Varmista, että kaikki suojukset ja kannet ovat paikoillaan ja tiukasti kiinni.

### Käynnistys

1. Varmista, että painekeytkimen kahva on **OFF (0)**-asennossa.
2. Kytke virtajohto maadoitettuun pistorasiaan.
3. Siirrä painekeytkimen kahva **ON (1)**-asentoon.
4. Näin paineilmakompressorin voi alkaa **Start** kasvattaa painetta ilmasäiliössä lopettaa **Stop**, kun oikea paine on saavutettu. Kun paine laskee käytön aikana, paineilmakompressorin alkaa taas kasvattaa painetta.
5. Painetta voi säätää kääntämällä paineensäätimen nuppia vastapäivään (vähemmän painetta) tai myötäpäivään (lisää painetta).
6. Jos huomaat epätavallisia ääniä tai tärinää, pysäytä paineilmakompressorin ja katso kappaletta "Vianetsintä."

### Sammutus

1. Kun haluat pysäyttää paineilmakompressorin, käännä painekeytkimen kahva **OFF (0)**-asentoon. ÄLÄ sammuta paineilmakompressorin irrottamalla pistoke pistorasiasta. Tästä voi seurata kuolettavan sähköiskun vaara.
2. Tyhjennä ilmasäiliö päästämällä ilma ulos laitteen mukana tulleella ilmaustyökalulla tai vetämällä varoventtiilin renkaasta.
3. Kun ilmasäiliöiden paine laskee alle 0.7 bar, avaa kunkin ilmasäiliön alaosassa oleva tyhjennysventtiili ja anna kosteuden valua ulos.
4. Anna kompressorin jäähtyä.
5. Pyyhi kompressorin puhtaaksi ja varastoi se varmaan paikkaan, jossa se ei pääse jäätymään.

## Huolto

Lue käyttöopas ennen kuin huollat laitetta. Paineilmakompressorin täytyy sammuttaa seuraavalla tavalla, ennen kuin sitä voi huoltaa tai korjata.

1. Sammuta paineilmakompressorin.



**Varoitus: Älä milloinkaan oletta, että on turvallista avata paineilmakompressorin vain, koska se ei ole käynnissä. Se voi käynnistyä uudelleen minä hetkenä tahansa!**

2. Irrota virtajohto verkkovirrasta.
3. Avaa kaikki tyhjennysventtiilit.
4. Odota, että paineilmakompressorin jäähtyy, ennen kuin alat huoltaa sitä.

Huoltotaulukko			
TOIMENPIDE	PÄIVITTÄIN	VIIKOITTAIN	KUUKAUSITTAIN
Poista kosteus ilmasäiliö(i)stä	X		
Tarkista epätavalliset äänet/tärinä	X		
Tarkista laite ilmavuotojen varalta	X		
Tutki ilmasuodatin		X	
Puhdista kompressorin ulkopinta		X	
Tarkista varoventtiili			X

## Vianetsintä

### Symptomi 1. Moottori ei käy tai käynnisty.

Todennäköinen Syy	Korjauskeino
<ul style="list-style-type: none"> <li>• Virtajohtoa ei ole kytketty.</li> </ul>	<ul style="list-style-type: none"> <li>• Kytke johto maadoitettuun pistorasiaan.</li> </ul>
<ul style="list-style-type: none"> <li>• Moottori-/painekeytkin <b>OFF (0)</b>-asennossa.</li> </ul>	<ul style="list-style-type: none"> <li>• Käännä kytkin <b>ON (1)</b>-asentoon.</li> </ul>
<ul style="list-style-type: none"> <li>• Moottorin yllämpökytkin on lauennut.</li> </ul>	<ul style="list-style-type: none"> <li>• Sammuta paineilmakompressorin, odota kunnes moottori on jäähtynyt, tarkista sitten moottorin virrankatkaisin.</li> </ul>
<ul style="list-style-type: none"> <li>• Sulake palanut tai virrankatkaisin lauennut.</li> </ul>	<ul style="list-style-type: none"> <li>• Vaihda sulake tai käännä virrankatkaisin takaisin.</li> <li>• Tarkista, että sulakkeiden ampeeriluku on oikea.</li> <li>• Tarkista alhaisen jännitteen olosuhteet.</li> <li>• Irrota kaikki muut sähkölaitteet virtapiiristä tai käytä paineilmakompressorin erillisessä haaroituskytkennässä.</li> </ul>
<ul style="list-style-type: none"> <li>• Väärä johdon paksuus tai jatkojohdon pituus.</li> </ul>	<ul style="list-style-type: none"> <li>• Tarkista oikea johdon paksuus ja pituus sivun 10 taulukosta.</li> </ul>
<ul style="list-style-type: none"> <li>• Ilmasäiliön paine on korkeampi kuin moottori-/painekeytkimen ala-arvo.</li> </ul>	<ul style="list-style-type: none"> <li>• Moottori käynnistyy automaattisesti, kun ilmanpaine laskee moottori-/painekeytkimen ala-arvon alapuolelle.</li> </ul>
<ul style="list-style-type: none"> <li>• Moottori-/painekeytkimen varoventtiili ei ole laskenut pumpun päälle painetta.</li> </ul>	<ul style="list-style-type: none"> <li>• Laske putki tyhjäksi kääntämällä kytkin <b>OFF (0)</b>-asentoon.</li> </ul>
<ul style="list-style-type: none"> <li>• Viallinen moottori, moottorin kondensaattori, moottori-/painekeytkin tai sulkuventtiili.</li> </ul>	<ul style="list-style-type: none"> <li>• Ota yhteys Sencon asiakaspalveluun.</li> </ul>

### Symptomi 2. Kun kompressorin ei käynnisty/pysähdy, vaan jatkaa käyntiä.

Todennäköinen Syy	Korjauskeino
<ul style="list-style-type: none"> <li>• Moottori-/painekeytkin ei sammuta moottoria, kun paineilmakompressorin ilmanpaine nousee yli yläarvon ja varoventtiili avautuu.</li> </ul>	<ul style="list-style-type: none"> <li>• Käännä moottori-/painekeytkin <b>OFF (0)</b>-asentoon. Jos moottori ei sammuta, irrota paineilmakompressorin johto pistorasiasta. Jos koskettimet ovat hitsautuneet yhteen, vaihda painekeytkin uuteen.</li> </ul>
<ul style="list-style-type: none"> <li>• Paineilmakompressorin on väärän kokoinen.</li> </ul>	<ul style="list-style-type: none"> <li>• Käytä ilmanpainetta, joka vastaa paineilmakompressorin kapasiteettia. Käytä joko pienempää työkalua tai suurempaa paineilmakompressorin.</li> </ul>

### Symptomi 3. Ilman vuoto jatkuu kompressorin käynnistä/pysäyksistä huolimatta.

Todennäköinen Syy	Korjauskeino
<ul style="list-style-type: none"> <li>• Sulkuventtiili on juuttunut auki.</li> </ul>	<ul style="list-style-type: none"> <li>• Irrota ja puhdista tai vaihda uuteen.</li> </ul>

### Symptomi 4. Moottorin käydessä ilmaa vuotaa jatkuvasti painekeytkimestä.

Todennäköinen Syy	Korjauskeino
<ul style="list-style-type: none"> <li>• Viallinen moottori-/painekeytkin.</li> </ul>	<ul style="list-style-type: none"> <li>• Vaihda uuteen.</li> </ul>

### Symptomi 5. Ilma vuotaa ylipaineventtiilistä.

Todennäköinen Syy	Korjauskeino
<ul style="list-style-type: none"> <li>• Mahdollisesti viallinen varoventtiili.</li> </ul>	<ul style="list-style-type: none"> <li>• Avaa varoventtiili käsin vetämällä renkaasta. Jos se vuotaa senkin jälkeen, vaihda se uuteen.</li> </ul>
<ul style="list-style-type: none"> <li>• Liian suuri ilmanpaine ilmasäiliössä.</li> </ul>	<ul style="list-style-type: none"> <li>• Viallinen moottori-/painekeytkin. Vaihda uuteen.</li> </ul>

<b>Vianetsintä</b>	
<b>Symptomi 6. Ilma vuotaa liittimistä.</b>	
<b>Todennäköinen Syy</b>	<b>Korjauskeino</b>
<ul style="list-style-type: none"> <li>• Liittimet eivät ole tarpeeksi kireällä.</li> </ul>	<ul style="list-style-type: none"> <li>• Kiristä liittimiä siellä, mistä ilmaa pääsee ulos. Tarkista liittimet saippuaveden avulla. Älä kiristä liikaa.</li> </ul>
<b>Symptomi 7. Ilma vuotaa säiliöstä.</b>	
<b>Todennäköinen Syy</b>	<b>Korjauskeino</b>
<ul style="list-style-type: none"> <li>• Viallinen tai ruostunut ilmasäiliö.</li> </ul>	<ul style="list-style-type: none"> <li>• Ilmasäiliö täytyy vaihtaa uuteen. Älä yritä korjata ilmasäiliötä! Älä hitsaa, dorjaa tai tee muutoksia.</li> </ul>
<b>Symptomi 8. Ilma vuotaa sisäänmenoventtiilistä.</b>	
<b>Todennäköinen Syy</b>	<b>Korjauskeino</b>
<ul style="list-style-type: none"> <li>• Vioittunut tuloventtiili (kieliventtiili).</li> </ul>	<ul style="list-style-type: none"> <li>• Ota yhteyttä SENCON asiakaspalveluun.</li> </ul>
<b>Symptomi 9. Riittämätön paine käytettävälle työkalulle.</b>	
<b>Todennäköinen Syy</b>	<b>Korjauskeino</b>
<ul style="list-style-type: none"> <li>• Paineensäätönappi on liian pienen paineen kohdalla tai paineensäädin on viallinen.</li> </ul>	<ul style="list-style-type: none"> <li>• Käännä paineensäätönappi oikeaan asentoon tai vaihda se uuteen.</li> </ul>
<ul style="list-style-type: none"> <li>• Sisäänottoilman suodattimessa on tukos.</li> </ul>	<ul style="list-style-type: none"> <li>• Puhdista.</li> </ul>
<ul style="list-style-type: none"> <li>• Ilmavuotoja.</li> </ul>	<ul style="list-style-type: none"> <li>• Etsi vuodot ja korjaa.</li> </ul>
<ul style="list-style-type: none"> <li>• Paineilmakompressori on liian pieni ilman tarpeeseen nähden.</li> </ul>	<ul style="list-style-type: none"> <li>• Tarkista lisälaitteen ilman tarve. Jos se on suurempi kuin paineilmakompressorin CFM tai painekapasiteetti, tarvitset suuremman paineilmakompressorin.</li> </ul>
<b>Symptomi 10. Kompressori ei tuota tarpeeksi ilmaa.</b>	
<b>Todennäköinen Syy</b>	<b>Korjauskeino</b>
<ul style="list-style-type: none"> <li>• Sisäänottoilman suodattimessa on tukos.</li> </ul>	<ul style="list-style-type: none"> <li>• Puhdista.</li> </ul>
<ul style="list-style-type: none"> <li>• Viallinen (kieli-)venttiili.</li> </ul>	<ul style="list-style-type: none"> <li>• Tyhjennä ilmasäiliö ja tarkista kuinka kauan täyden paineen pumpaamiseen menee aikaa. Vertaa teknisissä tiedoissa annettuun arvoon. Jos aika on lyhyempi, irrota pumpun pää ja tarkista venttiilin levy, puhdista tai vaihda uuteen.</li> </ul>
<b>Symptomi 11. Kosteutta, joka purkautuu ilmaan.</b>	
<b>Todennäköinen Syy</b>	<b>Korjauskeino</b>
<ul style="list-style-type: none"> <li>• Korkean ilmankosteuden aiheuttama kondensaatio ilmasäiliössä tai paineilmakompressori ei ole ollut päällä tarpeeksi kauan.</li> </ul>	<ul style="list-style-type: none"> <li>• Tyhjennä ilmasäiliö joka käytön jälkeen. Tyhjennä ilmasäiliö useammin kostealla säällä ja käytä ilmalinjan suodatinta</li> </ul>

<b>Tekniset Tiedot</b>		
<b>Malli # PC 1010EU</b>		
<b>Moottori</b>	Hevosvoima	0.5 HP (huippu) 0.3 KW
	Jännite	230V
	Virranvoimakkuus (amp)	2A
	Hz.	50
	Vaihe	Yksivaiheinen
	RPM	2850
<b>Kompressorin pumppu</b>	Sylinterien lukumäärä	1
	Kompressiovaihe	1
	Kampikammio	Alumiinia
	Laakerit	Kuulalaakerit
	Sylinteri	Alumiinia
	Venttiilit	Yksinkertainen kieliventtiili
	Pää	Alumiinia
	Suodatin	Irto-osa
<b>Moottori-/painekeytkimen asetukset</b>	Yläarvo	8.6 bar (125 PSI)
	Ala-arvo	6.6 bar (95 PSI)
	Säätövivut	ON (1) / OFF (0)
<b>Ilmasäiliö</b>	Kapasiteetti	3.8 Liter(1 Gallon)
<b>Suorituskyky</b>	L/Min Ilman siirtymä	32 (1.1 CFM)
	L/Min @ 2.8 bar	17 (0.6 CFM @ 40 PSI)
	L/Min @ 6.2 bar	10 (0.35 CFM @ 90 PSI)
	L/Min @ 6.9 bar	9 (0.31 CFM @ 100 PSI)
	Maksimipaine	8.6 bar (125 PSIG)
	Täyteenpumppausaika: 0-9 bar	160 seconds
	Palautumisaika: 7-9 bar	48 seconds
<b>Paino</b>	Netto	Netto
<b>Mitat</b>	P x L x K	36 x 33 x 25 cm
<b>Äänitaso</b>	Measured sound power level (dB)	78 dBA
	Guaranteed sound power level (dB)	81 dBA

### Vaatimustenmukaisuusvakuutus

Me Senco Brands, Inc.  
osoitteesta 4270 Ivy Pointe Blvd., Cincinnati, Ohio 45245  
seuraavien direktiivien mukaisesti:  
**Konedirektiivi 2006/42/EY**  
**Pressure Vessel Directive 2009/105/EC.**  
**EMC Directive 2004/108/EC**  
**Low Voltage Directive 2006/95/EC**  
**RoHS Directive 2011/65/EU**  
**Noise Emission Directive 2005/88/EC**  
julistamme yksinomaisella vastuullamme, että: Malli(t):  
**PC 1010 EU, PC 1010EU-2P, PC 1010EUS, PC 1010EUS-UK110,**  
**PC 1010PL, PC 1010S, PC 1010UK1, PC 1010UK2**  
on seuraavien asiakirjojen soveltuvin olennaisten työsuojeluvälineiden mukainen:  
**EN ISO 14121-1:2007, EN ISO 3744:1995, EN ISO 4871:2009,**  
**EN1012-1:2010, EN 60204-1:2006+A1:2009, EN286-1:1998**  
Allekirjoitus: Chris Klein  
Asema: Koneenrakennusjohtaja  
Antopaikka: Senco Brands, Inc.  
4270 Ivy Pointe Blvd., Cincinnati, Ohio 45245  
Alkuperäisjulkaisu: 4 Syyskuu 2014  
Valtuutettu edustaja:  
(jolla on teknisen tiedoston koontivaltuudet)  
Nimi: Peter van der Wel  
Osoite: Senco Brands B.V.  
Geurdeland 17E, 6673 DR Ardeist, The Netherlands

**1. Senco Professional End User Warranty Policy**

Considering the following constraints Senco underwrites the reliability and the quality of its supplied authorised Senco branded products.

1.1 Senco warrants to the end user that the following products will be free from defects in construction, assembly and material for the warranty period specified below.

Product	Warranty period
Senco ® XP Series-Red Cap, pneumatic tools	Five years
Senco ® XP Series-Black Cap, pneumatic tools	Two years
Senco Pro Series, pneumatic tools	One year
Senco Semi-Pro Series, pneumatic tools	One year
Senco DuraSpin ® Series, electric and battery tools	One year
Senco Cordless battery tools	Two years
Senco batteries and chargers for tools	One year
Senco gas tools	Two years
Senco Reconditioned Products	One year
Senco other tools	One year
Senco Compressors	One year

1.2 The warranty period starts on the day the end user purchases the product and/or 1 year after the tool has been deleted from the product line, which ever date comes first.

1.3 To claim warranty the end user needs to send the defective products or their parts, including the serial number and the original and dated sales receipt or proof of purchase from the original retailer or dealer, freight prepaid to the original retailer or dealer.

1.4 Senco is not obliged to do any repairs or replacements on any products or their parts on site.

1.5 During the warranty period Senco or its distributors will repair or replace defective products or their parts, exclusively or mainly as a result of an imperfection in construction, assembly or material, at Senco's option and expense, subject to the constraints of this warranty policy.

1.6 The repair or replacement of products or their parts under warranty, does in no case lead to prolongation of the warranty period. For every replacement product or part, the remaining original warranty period of the replaced product or part is applicable.

1.7 Senco will become the owner of the products or parts that have been replaced by Senco or its distributors as a result of being compliant to Senco's warranty, without being obligated any compensation in this matter.

1.8 Excluded from the warranty are:

- Normal wear and tear parts, for example rubber o-rings, seals, driver blades, piston stops, piston/driver assemblies, isolators, drive belts, air filters and fuel systems, bits;
- Any imperfection that is a result of or has evolved from the fact that there has not been used clean, dry regulated compressed air and/or the air pressure applied has exceeded the maximum indicated on the tool casting (pneumatic tools);
- Any imperfection that is a result of or has evolved from normal wear, misapplication, abuse/misuse, improper modifications or storage, shipping/transport, accidents, neglect, operation at other than recommended speeds or voltage (electric units only);
- Any imperfection that is a result of or has evolved from explosions, fires and natural disasters, like hurricanes, floods and earthquakes;
- Any imperfection that is a result of or has evolved from not following operating instructions, specifications and / or maintenance schedules. Read the Operator Manual for use, specifications and maintenance instructions;
- Any imperfection that is caused by repairs, modifications to the product or attempts to do so by the end user or any third party;
- Labour charges or loss or damage resulting from improper operation, maintenance or repairs are not covered by this warranty
- Any warranty claims that have been received after the warranty period, as specified in this end user warranty, has expired.

1.9 Additional costs like shipping/transport, special packaging requirements and costs of travel and accommodation, are at the end users expense.

1.10 If a complaint is unfounded, all costs incurred thereby, including handling, inspection, shipping and administrative costs on the side of Senco or its distributors, will be charged to the end user.

1.11 After expiration of the warranty period, all costs for repair or replacement, including handling, inspection, shipping and administrative costs will be charged to the end user.

1.12 Notwithstanding legal limitation periods, the limitation of all claims and appeals against Senco and third parties involved by Senco for the implementation of the agreement is one year.

1.13 If Senco fails to meet this agreement, it will not discharge the end user from the obligations arising under this or any other contract.

1.14 When the warranty terms can not be met, due to for example import or export prohibitions, strikes or other unforeseen circumstances, the warranty period will be extended accordingly.

1.15 Senco's liability is limited to the warranty. Senco is not liable for damage caused by the functioning or non-functioning of the products as delivered, repaired or modified by Senco or its distributors, including but not limited to, production losses, profit losses, reduced working range, commercial losses or consequential damages or indirect damages whatsoever.

## Electric Air Kompressori Parts Reference Guide

NO:RLB-1409

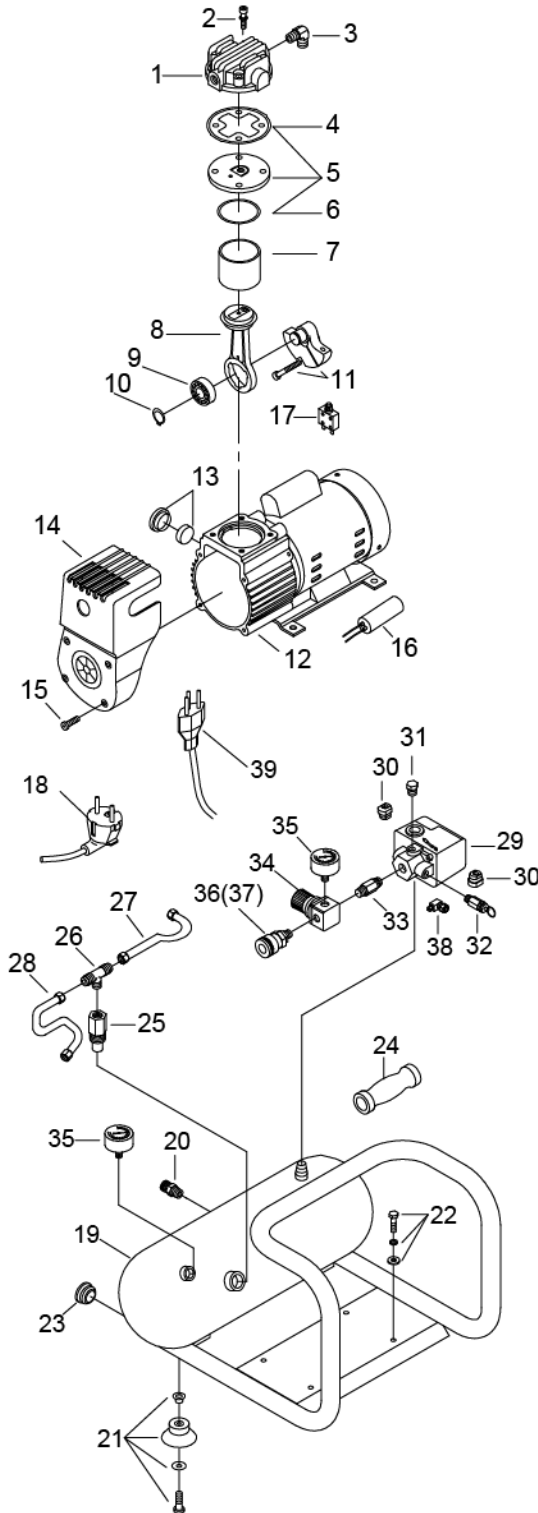

Ref. No.	Description	Part No.	Qty.
1	CYLINDER HEAD	3101063A	1
2	ALLEN BOLT SET	3B01-M05*060V	4
3	EXHAUST ELBOW	2N06-01T02H	1
4	CYLINDER HEAD GASKET	2G01-025H	1
5	EXHAUST VALVE ASSEMBLY	3B11-DC02A	1
6	VALVE SEAT GASKET	2G03-018	1
7	CYLINDER	3201068	1
8	ROD ASSEMBLY	3B3-MB02	1
9	BEARING	2N35-6201ZZC3	1
10	CLIP	2N42-S12	1
11	CRANKSHAFT & BALANCER	3304086	1
12	MOTOR SET	3B8-MB0206S	1
13	AIR FILTER SET	2140026RS	1
14	SHROUD	2428015RS	1
15	BOLT	2B02-FM4*015B	4
16	RUNNING CAPACITOR	2E27-004F4525	1
17	CIRCUIT BREAKER	2E25-01AS	1
18	POWER CABLE (2 PIN)	2E01-029S	1
19	AIR TANK	3401174U	1
20	DRAIN VALVE	2405012	1
21	RUBBER PAD SET	3433011-ARS	4
22	HEXAGON BOLT SET	3B00-FM06*012RS	4
23	PLUG	2N32-W07RS	2
24	GRIP	2432107	1
25	CHECK VALVE	2414033A	1
26	UNLOADING 3-WAY PIPE	2N09-02H01T02H4	1
27	UNLOADING TUBE	3B2-02*190F	1
28	DISCHARGE TUBE	2T02-02*0260RS	1
29	PRESSURE SWITCH	2E21-AA256BPS	1
30	STRAIN RELIEF BUSHING	2E04-008	2
31	PLUG	2N33-009	1
32	PRESSURE RELIEF VALVE	2406021A	1
33	NIPPLE	2N01-058RS	1
34	REGULATOR	2408008RRS	1
35	PRESSURE GAUGE	2D12-15D14BAR	2
36	QUICK COUPLER (FOR PC1010EU ONLY)	07S1/4M-ERS	1
37	QUICK COUPLER (FOR PC1010EU COMBO KIT, PC1010S, 6PR2001N)	07OS1/4M-C	1
38	UNLOADING VALVE	2409015	1
39	POWER CABLE (3 PIN)	2E01-044S	1



# Elektrisk Kompressor

## Bruksvisning

(Oversettelse Av De  
Originale Instruksjonene)



# SENCO®

Senco Brands, Inc.  
4270 Ivy Pointe Blvd.  
Cincinnati, OH 45245  
1-800-543-4596  
[www.senco.com](http://www.senco.com)  
EMEA: [www.senco-emea.com](http://www.senco-emea.com)



Denne brukerveiledningen inneholder advarsler og instruksjoner om sikker bruk av kompressoren.



Les og forstå alle instruksjonene.

## Innhold

Innledning.....	3
Inspeksjon .....	3
Sikkerhetsforskrifter .....	4
Kompressorens Deler .....	8
Klargjøring .....	10
Montering.....	10
Plassering.....	10
Elektriske Koplinger .....	10
Bruk.....	11
Sjekkliste Før Kompressoren Tas I Bruk.....	11
Oppstart.....	11
Avstenging .....	11
Vedlikehold.....	11
Feilsøking .....	12
Spesifikasjoner .....	14
Erklæring Om Samsvar .....	14
Begrenset Garanti .....	15
Parts Reference Guide.....	16

## Innledning

Gratulerer med din nye SENCO® Air Compressor! Vi kan forsikre deg om at SENCO Air Compressor er utformet med den aller største presisjon og nøyaktighet. Hver komponent er grundig testet av teknikere for å sikre at luftkompressoren har høy kvalitet, lang levetid og upåklagelig yteevne. Denne bruksanvisningen er utarbeidet som en hjelp for deg. Hvis du leser igjennom og følger de enkle instruksene for sikkerhet, installasjon, bruk og vedlikehold som er beskrevet her, får du glede av din nye SENCO Air Compressor i mange år fremover. Innholdet i bruksanvisningen er basert på den aller nyeste produktinformasjonen som var tilgjengelig på utgivelsestidspunktet. Produsenten forbeholder seg retten til når som helst og uten forvarsel å gjøre endringer i pris, farge, materiale og utstyr, spesifikasjoner og modell.



### Varselmerking!

En sikkerhetsmerking som viser "FARE, ADVARSEL eller FORSIKTIG" er omgitt av en egen "VARELSMERKINGSRAMME."

Denne rammen er med på å understreke de sikkerhetsinstruksene som må følges.

Sikkerhetsinstruksene ledsages dessuten av "signalord" som angir risikonivå. Følgende "signalord" er benyttet i denne bruksanvisningen:

**FARE:** Varsler om overhengende farlig situasjon som VIL forårsake død eller alvorlig skade dersom den ikke unngås.

**ADVARSEL:** Varsler om potensielt farlig situasjon som KAN forårsake død eller alvorlig skade dersom den ikke unngås.

**FORSIKTIG:** Varsler om potensielt farlig situasjon som KAN forårsake mindre personskader eller gjøre skade på kompressoren dersom den ikke unngås.



Symbolene til venstre for dette avsnittet er "varselsymboler." De skal gjøre oppmerksom på utstyr eller prosedyrer som kan være farlig for brukeren.

**SØRG FOR AT ALLE SOM BRUKER DETTE UTSTYRET, HAR TILGANG TIL DENNE BRUKSANVISNINGEN. LES ALLE INSTRUKSER I BRUKSANVISNINGEN NØYE. LES OGSÅ ALLE INSTRUKSER FRA LEVERANDØRER AV EVENTUELT TILBEHØR FØR KOMPRESSOREN TAS I BRUK. VÆR PÅPASSELIG MED Å VISE TIL "SIKKERHETSINSTRUKSENE", FOR Å HINDRE AT OPERATØREN KOMMER TIL SKADE.**

## Inspeksjon

Ta luftkompressoren ut av esken og noter serienummeret i feltet under. Sjekk om kompressoren har fått synlige eller skjulte skader under frakt. Se til at eventuelle skadede deler skiftes ut og at eventuelle mekaniske problemer rettes opp før luftkompressoren tas i bruk.

**SERIENUMMER** \_\_\_\_\_

Har du spørsmål eller kommentarer, kan du ringe SENCOs kundeservice gratis på: **1-800-543-4596** eller send e-post til: [toolprof@Senco.com](mailto:toolprof@Senco.com)

Vennligst ha følgende informasjon tilgjengelig ved alle servicehenvendelser:



1. Modellnummer
2. Serienummer
3. Innkjøpsdato og -sted

Senco, 4270 Ivy Pointe Blvd., Cincinnati, OH 45245

## Sikkerhetsforskrifter





### Les Alle Sikkerhetsforskrifter Før Kompressoren Tas I Bruk

Risiko	Mulige Konsekvenser	Forebyggende Tiltak
<p><b>Risiko For Elektrisk Støt Som Kan Være Livsfarlig</b></p>  	<ul style="list-style-type: none"> <li>Dersom luftkompressoren ikke er forsvarlig jordet, kan den forårsake død eller alvorlig skade. Kompressoren drives elektrisk og kan gi elektrisk støt, som i verste fall kan være livsfarlig, dersom den ikke anvendes korrekt.</li> </ul>	<ul style="list-style-type: none"> <li>Pass på at luftkompressoren er tilkopleet en stikkontakt som er forsvarlig jordet, har riktig spenning og tilstrekkelig kapasitet på sikringen.</li> </ul>
	<ul style="list-style-type: none"> <li>Strømførende ledninger kan gi elektrisk støt.</li> </ul>	<ul style="list-style-type: none"> <li>Kontroller om de strømførende ledningene har vært utsatt for klem-, kutt- eller varmeskader. Skift ut skadet ledning før bruk.</li> <li>Pass på at alle koplinger er tørre og befinner seg over bakken. Elektriske ledninger skal ikke ligge i vann eller på annen måte komme i kontakt med vann. Ikke berør kontaktene med våhender.</li> <li>Trekk ikke i ledningen når du skal ta støpselet ut av stikkontakten.</li> </ul>
	<ul style="list-style-type: none"> <li>Brukeren kan få elektrisk støt dersom kompressoren ikke anvendes korrekt.</li> </ul>	<ul style="list-style-type: none"> <li>Luftkompressoren må ikke anvende i fuktige omgivelser eller utendørs i regn.</li> <li>Luftkompressoren må ikke anvendes når sikkerhetsskjermer og -deksler fjernet eller skadet.</li> </ul>
	<ul style="list-style-type: none"> <li>Alle reparasjoner på det elektriske anlegget kan medføre livsfare og må utføres av kvalifiserte fagfolk.</li> </ul>	<ul style="list-style-type: none"> <li>Alt elektrisk koplingsarbeid og alle elektriske reparasjoner på kompressoren må utelukkende utføres av kvalifisert servicepersonale i henhold til nasjonale og lokale retningslinjer for elektrisk utstyr.</li> <li>Slå alltid av luftkompressoren, slipp ut luften og ta støpselet ut av stikkontakten og vent til kompressoren er avkjølt før du åpner deksler som gir tilgang til elektriske komponenter. Når kompressoren er tilkopleet, er det ikke trygt å utføre reparasjoner eller annet arbeid på kompressoren selv om motoren ikke går. Den kan starte opp når som helst!</li> </ul>

## Sikkerhetsforskrifter



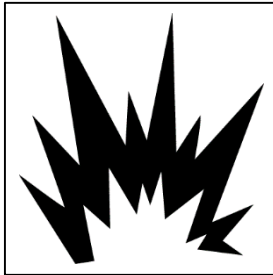

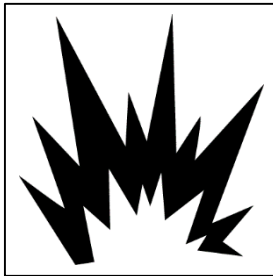

### Les Alle Sikkerhetsforskrifter Før Kompressoren Tas I Bruk

Risiko	Mulige Konsekvenser	Forebyggende Tiltak
<p><b>Eksplisjons- Eller Brannfare</b></p>  	<ul style="list-style-type: none"> <li>• Elektriske gnister i motor- og trykkbryter kan forårsake alvorlig personskade eller død.</li> <li>• Tette ventilatoråpninger kan føre til brann på grunn av overoppheting av kompressoren, og forårsake alvorlig personskade.</li> </ul>	<ul style="list-style-type: none"> <li>• Pass på at kompressoren alltid står på et godt ventilert sted uten brannfarlige avgasser, lettantennelig støv, gasser eller materiale når den er i bruk.</li> <li>• Skal kompressoren benyttes til å sprøyte brennbart materiale, må den stå minst 6 meter unna det området der sprøytingen foregår. (Det kan være nødvendig å forlenge slangen for å nå frem.)</li> <li>• Plasser aldri gjenstander rundt eller oppå luftkompressoren. Pass på at kompressoren har minst 30 cm klaring til vegg eller annet som kan hindre god ventilasjon.</li> </ul>
<p><b>Eksplisjonsfare</b></p> 	<ul style="list-style-type: none"> <li>• Lufttankene kan eksplodere og forårsake alvorlig personskade eller død dersom de ikke vedlikeholdes forskriftsmessig.</li> <li>• Benyttes feil systemkomponenter, tilleggsutstyr eller tilbehør, kan det oppstå funksjonsfeil eller eksplisjoner som kan forårsake alvorlig personskade.</li> </ul>	<ul style="list-style-type: none"> <li>• Tøm lufttanken daglig eller etter hver bruk for å motvirke kondensdannelse.</li> <li>• Oppstår det lekkasje fra lufttanken, må tanken byttes umiddelbart. Forsøk aldri å reparere, sveise eller på annen måte forandre på lufttanken eller tilbehøret.</li> <li>• De trykkinnstillingene som er fastsatt på fabrikken, må ikke endres.</li> <li>• Produsentens grenser for høyeste tillatte trykk på tilbehør må ikke overstiges.</li> <li>• Plastrør eller bly-/tinnloddede skjøter må ikke benyttes på utløpsrøret på grunn av svært høy temperatur.</li> <li>• Luftkompressoren må aldri benyttes til å blåse opp små gjenstander som tåler lite trykk, for eksempel leker.</li> <li>• Alle slanger og tilbehør er passende for stedbruk på maksimum tillatelig arbeidstrykk av den transportable kompressoren.</li> <li>• Bruk kun originale SENCO-deler til reparasjon av kompressoren.</li> </ul>

## Sikkerhetsforskrifter





### Les Alle Sikkerhetsforskrifter Før Kompressoren Tas I Bruk

Risiko	Mulige Konsekvenser	Forebyggende Tiltak
<p><b>Innåndingsfare</b></p> 	<ul style="list-style-type: none"> <li>• Komprimert luft må ikke inhaleres da dette kan forårsake alvorlig skade eller død. Luften kan inneholde karbonmonoksid, giftige avgasser eller partikler.</li> <li>• Sprøytematerialer som maling, løsemidler, malingsfjerner, insektmidler, ugressmidler, med mer, inneholder skadelige avgasser og gifter.</li> </ul>	<ul style="list-style-type: none"> <li>• Innhaler aldri luft direkte fra luftkompressoren eller via utstyr soer koplet til kompressoren.</li> <li>• Pass på at luftkompressoren alltid står i et godt ventilert rom under bruk. Følg alle sikkerhetsinstruksjoner som gjelder for de stoffene du sprøyter med. Med noen av stoffene kan det være nødvendig å bruke friskluftmaske.</li> </ul>
<p><b>Brannsfare</b></p> 	<ul style="list-style-type: none"> <li>• Utildekkede metalldele må ikke berøres da det kan forårsake alvorlig skade. Det kan ta litt tid før disse delene avkjøles etter at kompressoren er slått av.</li> </ul>	<ul style="list-style-type: none"> <li>• Pass på at verken du selv eller materialer kommer i kontakt med utildekkede metalldele på kompressoren, motor, eller rør.</li> </ul>
<p><b>Fare For Fragmenter I Luften</b></p> 	<ul style="list-style-type: none"> <li>• Trykkluffen kan forårsake skade på mykt vev.</li> </ul>	<ul style="list-style-type: none"> <li>• Bruk alltid godkjente vernebriller (Z87) for å skjerme øynene mot avfallsstoffer og fragmenter som virvles opp i luften.</li> <li>• Trykkluffstrømmen må aldri rettes mot mennesker eller dyr.</li> <li>• Ikke la en kompressor med trykkluff stå uten tilsyn. Slå av kompressoren og tøm den for luft før du utfører vedlikehold eller kople til verktøy eller tilbehør.</li> </ul>
<p><b>Ha Godt Fotfeste Og God Balanse Hele Tiden</b></p> 	<ul style="list-style-type: none"> <li>• Fragmenter som virvles opp av trykkluffen med høy hastighet, kan forårsake alvorlig skade.</li> </ul>	<ul style="list-style-type: none"> <li>• Hold alltid god avstand til menneske og dyr når kompressoren er i bruk.</li> <li>• Ikke flytt på kompressoren mens lufttanken er under trykk. Ikke forsøk å flytte på kompressoren ved å trekke i luftslangen.</li> </ul>

## Sikkerhetsforskrifter



### Les Alle Sikkerhetsforskrifter Før Kompressoren Tas I Bruk

Risiko	Mulige Konsekvenser	Forebyggende Tiltak
<p><b>Bevegelige Deler Medfører Fare</b></p>  <p><b>Advarsel: Kompressor Kan Starte Uten Frovarsel</b></p> 	<ul style="list-style-type: none"> <li>Fare for personskade fra bevegelige deler. Kompressoren slår seg automatisk av og på når bryteren står i <b>ON (1)</b>/Auto-stilling.</li> </ul>	<ul style="list-style-type: none"> <li>Slå alltid av kompressoren når den ikke er i bruk. Slipp opp på trykket gjennom luftslangen og ta støpselet ut av stikkontakten før vedlikehold utføres. Alle reparasjoner skal utføres av godkjent servicepersonale. Når kompressoren er tilkoplest, er det ikke trygt å utføre reparasjoner eller annet arbeid på kompressoren selv om motoren ikke går. Den kan starte onår som helst!</li> <li>Kompressoren må ikke benyttes dersom beskyttelsesdeksler og -skjermer ikke er på plass. Skift ut skadede deksler og skjermer før kompressoren tas i bruk.</li> </ul>
<p><b>Uforsvarlig Bruk Medfører Risiko</b></p> 	<ul style="list-style-type: none"> <li>Uforsvarlig bruk kan forårsake skade.</li> </ul>	<ul style="list-style-type: none"> <li>Denne luftkompressoren må ikke betjenes av barn!</li> <li>Vær årvåken – følg nøye med på ddu gjør. Unngå å bruke kompressoren når du er trett eller påvirket av medisiner, alkohol eller rusmidler.</li> <li>Sørg for at du vet hvordan du slår av kompressoren. Gjør deg godt kjent med alle brytere og kontroller.</li> </ul>
<p><b>Fare For At Kompressoren Kommer Til Skade</b></p>	<ul style="list-style-type: none"> <li>Større reparasjoner.</li> </ul>	<ul style="list-style-type: none"> <li>Kompressoren må ikke benyttes utluftfilter.</li> <li>Kompressoren må ikke benyttes i et miljø der den kan ruste.</li> <li>Pass på at kompressoren står stabilt og sikkert slik at den ikke kan velte når den er i bruk.</li> <li>Følg alle vedlikeholdsinstruksjoner i denne bruksanvisningen.</li> </ul>

**! TA VARE PÅ DISSE INSTRUKSENE!**

## Kompressorens Deler

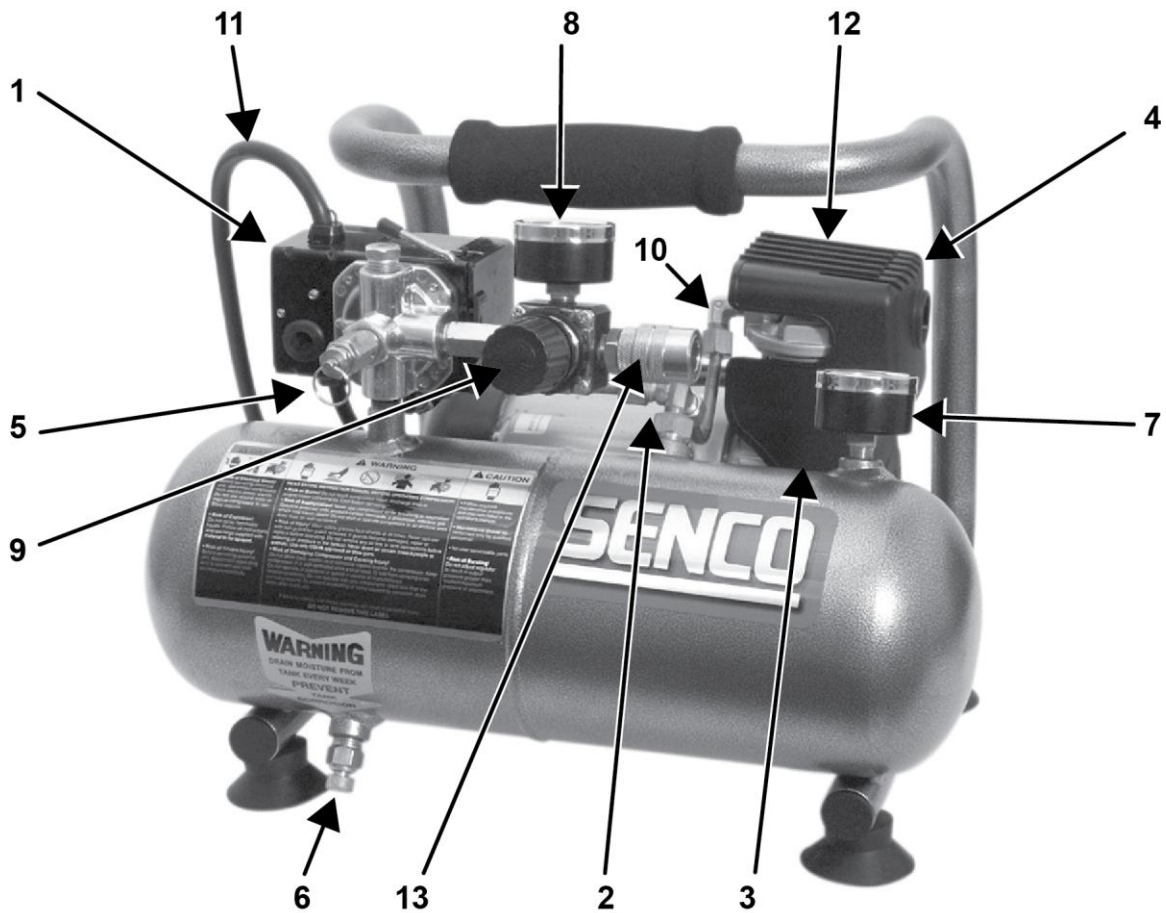

1.	Motor-/trykkbryter
2.	Termisk overlast/Tilbakestill
3.	Luftinntaksfilter
4.	Luftkompressorpumpe
5.	Sikkerhetsventil
6.	Ventil til tapping av tanken
7.	Tanktrykkmåler
8.	Trykkmåler ved uttaket
9.	Trykkregulator
10.	Utløpsrør
11.	Strømkabel
12.	Ventilåpninger / Beskyttelsesdeksel
13.	Hurtigfrakopling



## Kompressorens Deler

**1) Motor-/Trykkbryter:** Bryteren starter og stanser luftkompressoren. Når bryteren settes i **ON (1)**-stilling, aktiveres trykkbryteren som sørger for at motoren starter automatisk når trykket i lufttanken synker under det nivået fabrikken har angitt. Når den står i **ON (1)**-stilling, stanser trykkbryteren motoren når trykket i lufttanken kommer opp på det nivået fabrikken har angitt. Av sikkerhetshensyn har bryteren også en trykkventil på siden. Denne slipper automatisk ut komprimert luft fra pumpehodet og utløpsrøret når trykket i kompressoren når opp på det angitte nivået. Slik vil motoren kunne starte og stoppe etter behov. Settes bryteren i **OFF (0)**-stilling, deaktiveres trykkbryteren og luftkompressoren stanser.

**2) Overbelastning Av Motor:** Motoren har en vernebryter som er montert på pumpen. Hvis strømstyrken blir for høy fører det til at bryteren utløses for å beskytte motoren og brukeren. Tilbakestill bryteren ved å skyve den sorte plastdelen inn i huset. Tilbakestill bryteren hvis den er utløst.

**3) Luftinntaksfilter:** Filteret renser luften som dras inn i pumpen. For å sikre at pumpen mates med en jevn strøm av ren, kjølig og tørr luft, må filteret alltid være rent, og ventilasjonsåpningen må ikke tilstoppes. Filteret kan tas ut og rengjøres med varmt såpevann. Skyll filteret og la det lufttørke.

**4) Luftkompressorpumpe:** Stempelet komprimerer luften ved å bevege seg opp og ned i sylindere. Når stempelet går ned, trekkes luft inn gjennom inntaksventilen mens utløpsventilen er lukket. Når stempelet går opp, komprimeres luften, inntaksventilen lukkes og komprimert luft presses ut gjennom utløpsventilen, inn i utløpsrøret, gjennom tilbakeslagsventilen og inn i lufttanken.

**5) Sikkerhetsventil:** Denne ventilen skal hindre systemsvikt ved å lette på trykket når den komprimerte luften når et fastsatt nivå. Ventilen er forhåndsinnstilt av produsenten og må ikke endres. Du kan sjekke om ventilen fungerer som den skal, ved å trekke i ringen. Dette skal føre til at luft slippes ut og trykket letter. Ventilen lukkes igjen når ringen slippes.

**6) Ventil Til Tapping Av Tanken:** Tappeventilen brukes til å fjerne kondens fra lufttanken(e) etter at kompressoren er slått av. Du må **ALDRI åpne tappeventilen når lufttrykket i tanken er høyere enn 0.7 bar!** Tappeventilen åpnes ved at håndtaket dreies mot klokken. Hell på tanken slik at all kondensen renner ut gjennom ventilen.

**7) Tanktrykkmåler:** Tanktrykkmåleren viser lufttrykket i lufttanken(e).

**8) Trykkmåler Ved Uttaket:** Trykkmåleren ved uttaket angir tilgjengelig lufttrykk på den siden av regulatoren der luften slippes ut. Trykket kontrolleres av regulatoren og er alltid mindre enn eller likt som trykket i lufttanken.

**9) Trykkregulator:** Lufttrykket ut fra tanken kontrolleres med regulatorskruen. Vri trykkregulatorskruen med klokken for å øke trykket, og mot klokken for å redusere trykket. Følg bruksanvisningen for verktøyet for å finne anbefalt trykkområde.

**10) Utløpsrør:** Merk! Utløpsrøret er svært varmt. Fjern ikke dekselet, kompressordel under kan være meget varm.

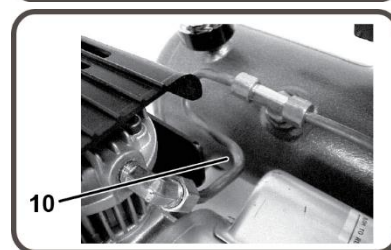
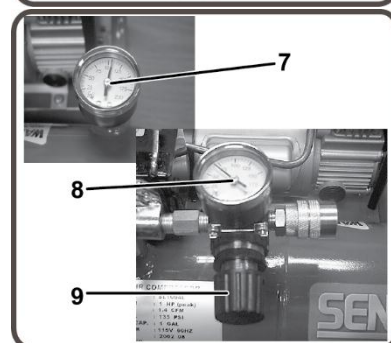
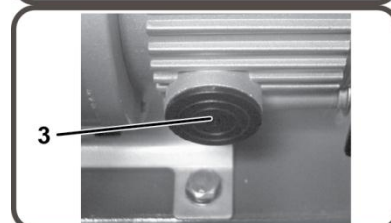
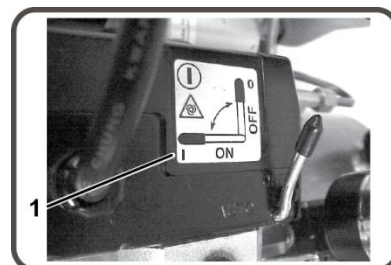

### Montering

1. Les sikkerhetsforskriftene før du monterer sammen kompressoren.

### Plassering

**Forsiktig** Kompressoren kan ta skade dersom den heller mer enn 10° under bruk.

1. Det bør være minst 30 cm klaring rundt kompressoren for å sikre tilstrekkelig ventilasjon.

Pass på at kompressoren ikke står et sted der:

- Det er olje- eller gasslekkasje.
- Det kan befinne seg brennbare avgasser eller materialer.

#### Advarsel



Dersom elektriske gnister fra motoren og trykkbryteren kommer i kontakt med brennbare avgasser, brennbart støv, gasser eller annet lettantennelig materiale, kan dette forårsake alvorlig personskade eller død. Når luftkompressoren benyttes til sprøytelakkering, skal kompressoren plasseres lengst mulig unna arbeidsområdet. Skjøt på luftslangen i stedet for å benytte skjøteledning.

- Når temperaturen i luften faller under 0C eller overstiger 40C.
- Når svært forurenset luft eller vann kan trekkes inn i kompressoren.

### Elektriske Koplinger

#### Fare



Uforsvarlig tilkopling av jordingsleder kan gi elektrisk støt som kan være livsfarlig. Konsulter godkjent elektriker eller verksted hvis du er i tvil om uttaket er forskriftsmessig jordet. Dette produktet må ikke brukes med adapter av noe slag. Skal ledningen eller støpselet repareres eller byttes ut, må jordingsledningen ikke koples til selve kontaktpluggene. Jordingsledningen er den ledningen som har grønn isolasjon, av og til med gule striper.

#### Advarsel



Dette produktet må jordes. Hvis det oppstår en feil eller svikt, fungerer jordingen som en minste motstands vei som strømmen vil følge. Dermed reduseres faren for elektrisk støt. Dette produktet er utstyrt med en ledning med jordingsleder og jordingsstøpsel. Støpselet må plugges inn i et uttak som er forskriftsmessig installert og jordet i henhold til lokale forskrifter og bestemmelser.

1. SENCO® ANBEFALER IKKE BRUK AV SKJØTELEDNINGER ettersom det kan forårsake strømtpap og overoppheting av motoren. I stedet bør du forlenge luftslangen. Er det allikevel helt nødvendig å benytte skjøteledning, skal den plugges i jordet stikkontakt eller på annen måte beskyttes av jordfeil-/overbelastningsbryter.

Benyttes skjøteledning, bør følgende skjema følges:

<u>Skjema for kabellengde</u>	<u>(American Wire Gauge)</u>
Inntil 7,5 m	12 AWG
Inntil 30 m	10 AWG
Inntil 50 m	8 AWG
Inntil 75 m	6 AWG

Benytt kun skjøteledning som er jordet og som passer til produktet. Benytt aldri skjøteledninger som har lavere kapasitet enn det som er angitt på produktet. Benytt aldri skjøteledning som er skadet. Se over skjøteledningen før bruk, og skift den ut dersom den er skadet. Behandle skjøteledningen varsomt og unngå å dra i selve ledningen når du skal trekke ut støpselet. Hold ledningen unna skarpe kanter og varme. Slå alltid av kompressoren med hovedbryteren før du trekker støpselet ut av stikkontakten.

## Bruk

### Sjekkliste Før Kompressoren Tas I Bruk

1. Fjern eventuell kondens i luftkompressortanken. Slipp ut luft gjennom slangen hvis trykket er for høyt, og åpne deretter tappeventilen i bunnen av lufttanken for å tømme den helt. Slipp ut trykket ved å dra i ringen til sikkerhetsventilen eller ved hjelp av luftverktøyet, og åpne deretter tømmeventilen i bunnen av lufttanken. Skru ventilen godt til når tanken er tømt.



**Advarsel:** Fare for personskade. Du må **ALDRI** åpne tappeventilen når lufttrykket i tanken er høyere enn 0.7 bar!

2. Pass på at motorbryteren står i **OFF (0)**-stilling.
3. Sjekk at alle sikkerhetsventiler fungerer forskriftsmessig.
4. Sjekk at alle skjermene og deksler sitter på plass og er forskriftsmessig montert.

### Oppstart

1. Pass på at spaken på trykkbryterboksen står i **OFF (0)**-stilling.
2. Plugg inn strømkabelen i en jordet stikkontakt.
3. Sett spaken på trykkbryterboksen i **ON (1)**-stilling.
4. Luftkompressoren vil da begynne å bygge opp lufttrykket i lufttanken(e) og stanser når den har nådd fastsatt trykk. Når trykket faller fordi kompressoren er i bruk, starter motoren igjen, og trykket bygges på ny opp.
5. Still inn trykket. Du reduserer trykket ved å vri trykkregulatorskruen mot klokken og øker det ved å vri skruen med klokken.
6. Slå av kompressoren hvis du hører ulyder eller kompressoren begynner å riste. Les under "Feilsøking."

### Avstenging

1. Du slår av luftkompressoren ved å sette spaken på trykkbryterboksen i **OFF (0)**-stilling. Slå **ALDRI** av kompressoren ved å trekke ut støpselet fra stikkontakten. Det kan gi livsfarlig støt.
2. Tøm tanken for luft ved å slippe ut luften via et luftverktøy eller ved å trekke i ringen på sikkerhetsventilen.
3. Når trykket i lufttanken(e) er lavere enn 0.7 bar, kan du åpne tappeventilen under lufttanken(e) for å tappe ut eventuell kondens.
4. La kompressoren avkjøles.
5. Tørk av kompressoren og lagre den på et trygt, frostfritt sted.

## Vedlikehold

Les bruksanvisningen før du utfører vedlikehold. Følgende punkter må følges når du skal stanse kompressoren for å utføre vedlikehold eller service.

1. Slå av kompressoren.



**Advarsel:** Når kompressoren er tilkople, er det ikke trygt å utføre reparasjoner eller annet arbeid på kompressoren selv om motoren ikke går. Den kan starte opp når som helst!

2. Trekk ut støpselet fra stikkontakten.
3. Åpne alle tappeventiler.
4. Vent til kompressoren er avkjølt før servicearbeidet starter.

Vedlikeholdsskjema			
Prosedyre	Daglig	Ukentlig	Månedlig
Tapp ut kondens fra lufttanken(e)	X		
Sjekk om kompressoren lager uvanlig støy eller rister	X		
Sjekk om det er luftlekkasjer	X		
Inspiser luftfilteret		X	
Rengjør kompressoren utvendig		X	
Sjekk sikkerhetsventilen			X

## Feilsøking

<b>Symptom 1: Motoren starter ikke.</b>	
<b>Mulig Årsak</b>	<b>Tiltak</b>
<ul style="list-style-type: none"> <li>• Strømledningen er ikke satt i.</li> </ul>	<ul style="list-style-type: none"> <li>• Plugg i strømledningen i jordet uttak.</li> </ul>
<ul style="list-style-type: none"> <li>• Motor-/trykkbryteren står i <b>OFF (0)</b>-stilling.</li> </ul>	<ul style="list-style-type: none"> <li>• Sett bryteren i <b>ON (1)</b>-stilling.</li> </ul>
<ul style="list-style-type: none"> <li>• Bryteren for termisk overlast i motoren har løst seg ut.</li> </ul>	<ul style="list-style-type: none"> <li>• Slå av luftkompressoren, vent til motoren er avkjølt og sjekk så motorens overbelastningsbryter.</li> </ul>
<ul style="list-style-type: none"> <li>• En sikring har gått eller overbelastningsbryteren har løst seg ut.</li> </ul>	<ul style="list-style-type: none"> <li>• Bytt sikring eller tilbakestill overbelastningsbryteren. Sjekk om sikringene har riktig amperestyrke. Sjekk om spenningen er for lav. Kople eventuelt annet elektrisk utstyr fra kretsen eller kjør kompressoren på en egen avgrening.</li> </ul>
<ul style="list-style-type: none"> <li>• Feil dimensjon eller lengde på skjøteledning.</li> </ul>	<ul style="list-style-type: none"> <li>• Bruk skjemaet på side 10 til å kontrollere om ledningen har riktig dimensjon og lengde.</li> </ul>
<ul style="list-style-type: none"> <li>• Trykket i lufttanken er høyere enn motor-/trykkbryterens angitte aktiveringsnivå.</li> </ul>	<ul style="list-style-type: none"> <li>• Motoren starter automatisk når trykket i lufttanken synker under det aktiveringsnivået som er angitt for motor-/trykkbryteren.</li> </ul>
<ul style="list-style-type: none"> <li>• Trykkventilen på motor-/trykkbryteren har ikke sluppet ut trykket i pumpehodet.</li> </ul>	<ul style="list-style-type: none"> <li>• Tapp røret tomt ved å sette bryteren i <b>OFF (0)</b>-stilling.</li> </ul>
<ul style="list-style-type: none"> <li>• Defekt motor, motorkondensator, motor-/trykkbryter, eller tilbakslagsventil.</li> </ul>	<ul style="list-style-type: none"> <li>• Kontakt SENCOS kundeservice.</li> </ul>
<b>Symptom 2: Motoren går kontinuerlig når bryteren står i start/stop-stilling.</b>	
<b>Mulig Årsak</b>	<b>Tiltak</b>
<ul style="list-style-type: none"> <li>• Motor-/trykkbryteren slår ikke av motoren når kompressortrykket når opp i det angitte deaktivertingsnivået. Dermed utløses sikkerhetsventilen.</li> </ul>	<ul style="list-style-type: none"> <li>• Sett motor-/trykkbryteren i <b>OFF (0)</b>-stilling. Dersom motoren ikke kan slås av, trekker du ut støpselet til kompressoren. Dersom de elektriske kontaktpunktene er smeltet sammen, må trykkbryteren skiftes.</li> </ul>
<ul style="list-style-type: none"> <li>• Kompressoren har feil størrelse.</li> </ul>	<ul style="list-style-type: none"> <li>• Pass på at trykkbelastningen ikke overstiger kompressorens kapasitet. Benytt enten mindre verktøy eller større kompressor.</li> </ul>
<b>Symptom 3: Luft lekker ut fra ventilen på motor-/trykkbryteren etter at motoren er stanset.</b>	
<b>Mulig Årsak</b>	<b>Tiltak</b>
<ul style="list-style-type: none"> <li>• Sjekk om ventilen står åpen.</li> </ul>	<ul style="list-style-type: none"> <li>• Fjern, rengjør eller skift ut.</li> </ul>
<b>Symptom 4: Luft lekker ut fra ventilen på motor-/trykkbryteren mens motoren går.</b>	
<b>Mulig Årsak</b>	<b>Tiltak</b>
<ul style="list-style-type: none"> <li>• Defekt motor-/trykkbryter. Skift ut.</li> </ul>	<ul style="list-style-type: none"> <li>• Defekt motor-/trykkbryter. Skift ut.</li> </ul>
<b>Symptom 5: Luft lekker ut ved sikkerhetsventilen.</b>	
<b>Mulig Årsak</b>	<b>Tiltak</b>
<ul style="list-style-type: none"> <li>• Sikkerhetsventilen kan være defekt.</li> </ul>	<ul style="list-style-type: none"> <li>• Betjen sikkerhetsventilen manuelt ved å trekke i ringen.</li> </ul>
<ul style="list-style-type: none"> <li>• For høyt trykk i lufttanken.</li> </ul>	<ul style="list-style-type: none"> <li>• Hvis den fortsatt lekker, må ventilen skiftes ut. Defekt motor-/trykkbryter. Skift ut.</li> </ul>

## Feilsøking

### Symptom 6: Luft lekker ut ved koplinger.

Mulig Årsak	Tiltak
<ul style="list-style-type: none"><li>• Koplingene er ikke tette nok.</li></ul>	<ul style="list-style-type: none"><li>• Stram til koplinger der luften slipper ut. Bruk såpevann. Stram ikke til for mye.</li></ul>

### Symptom 7: Luft lekker ut fra lufttanken.

Mulig Årsak	Tiltak
<ul style="list-style-type: none"><li>• Defekt eller rustet lufttank.</li></ul>	<ul style="list-style-type: none"><li>• Lufttank må skiftes ut. Forsøk ikke å reparere tanken! Ikke foreta modifikasjoner, sveising eller reparasjon av deler.</li></ul>

### Symptom 8: Luft blåser ut fra inntaksfilteret.

Mulig Årsak	Tiltak
<ul style="list-style-type: none"><li>• Skadet inntaksventil.</li></ul>	<ul style="list-style-type: none"><li>• Kontakt SENCO kundeservice.</li></ul>

### Symptom 9: For lavt trykk på luftverktøy eller tilbehør.

Mulig Årsak	Tiltak
<ul style="list-style-type: none"><li>• Trykkregulatorskruen er ikke stilt inn på høyt nok trykk, eller trykkregulatoren er defekt.</li></ul>	<ul style="list-style-type: none"><li>• Vri trykkregulatorbryteren til korrekt innstilling eller skift den ut.</li></ul>
<ul style="list-style-type: none"><li>• Luftinntaksfilteret er tett.</li></ul>	<ul style="list-style-type: none"><li>• Rengjør.</li></ul>
<ul style="list-style-type: none"><li>• Luftlekkasje.</li></ul>	<ul style="list-style-type: none"><li>• Sjekk om det er lekkasje. Reparer eventuelle lekkasjer.</li></ul>
<ul style="list-style-type: none"><li>• Luftkompressor har for liten kapasitet til å dekke luftbehovet.</li></ul>	<ul style="list-style-type: none"><li>• Sjekk hvor høyt trykk tilbehøret krever. Dersom dette kravet er høyere enn kompressorens trykkapasitet (CFM, kubikkfot pr. minutt), må du benytte en større kompressor.</li></ul>

### Symptom 10: Kompressoren produserer ikke nok luft.

Mulig Årsak	Tiltak
<ul style="list-style-type: none"><li>• Tett luftinntaksfilter.</li></ul>	<ul style="list-style-type: none"><li>• Rengjør.</li></ul>
<ul style="list-style-type: none"><li>• Defekt ventil.</li></ul>	<ul style="list-style-type: none"><li>• Tøm lufttanken helt og fyll den opp til maksimalt trykk igjen. Sammenlign med spesifikasjonene. Er trykket da for lavt, fjerner du pumpehodet og inspiserer ventilmembranen. Rengjør eller skift den ut.</li></ul>

### Symptom 11: Kondens i lufttanken.

Mulig Årsak	Tiltak
<ul style="list-style-type: none"><li>• Kondens i lufttanken som følge av høy luftfuktighet, eller fordi kompressoren ikke er kjørt lenge nok.</li></ul>	<ul style="list-style-type: none"><li>• Tapp alltid lufttanken tom etter bruk. Tøm lufttanken hyppigere i fuktig vær og benytt luftfilter.</li></ul>

## Spesifikasjoner

Modell # PC 1010EU		
<b>Motor</b>	Hestekrefter	0.5 HP (maks) / 0.3 KW
	Spenning	230V
	Ampere	2A
	Hz.	50 Hz
	Fase	Single
	RPM (rotasjoner pr minutt)	2850
<b>Kompressorpumpe</b>	Antall sylindere	1
	Komprimeringsnivå	1
	Veivhus	Aluminium
	Lager	Kule
	Sylinder	Aluminium
	Ventiler	Reed. enkel
	Hode	Aluminium
	Filter	Utskiftbart
<b>Innstilling for motor-/trykkbryter</b>	Deaktiver	8.6 bar (125 PSI)
	Aktiver	6.6 bar (95 PSI)
	Funksjoner	ON (1) / OFF (0)
<b>Lufttank</b>	Kapasitet	3.8 Liter(1 Gallon)
<b>Ytelse</b>	L/Min Luftfortrenging i	32 (1.1 CFM)
	L/Min @ 2.8 bar	17 (0.6 CFM @ 40 PSI)
	L/Min @ 6.2 bar	10 (0.35 CFM @ 90 PSI)
	L/Min @ 6.9 bar	9 (0.31 CFM @ 100 PSI)
	Maksimalt trykk	8.6 bar (125 PSIG)
	Oppumpingstid: 0-9 bar	160 sekunder
	Gjenoppumpingstid: 7-9 bar	48 sekunder
<b>Vekt</b>	Netto	9.1 kg
<b>Dimensjoner</b>	Lengde x bredde x høyde	36 x 33 x 25 cm
<b>Noise</b>	Measured sound power level (dB)	78 dBA
	Guaranteed sound power level (dB)	81 dBA

## Erklæring Om Samsvar

Vi, Senco Brands, Inc. med adresse 4270 Ivy Pointe Blvd., Cincinnati, Ohio 45245 erklærer i henhold til følgende direktiv(er):  
**Maskindirektiv 2006/42/EF**  
**Pressure Vessel Directive 2009/105/EC.**  
**EMC Directive 2004/108/EC**  
**Low Voltage Directive 2006/95/EC**  
**RoHS Directive 2011/65/EU**  
**Noise Emission Directive 2005/88/EC**  
 under vårt eneansvar at Modell(er):  
**PC 1010 EU, PC 1010EU-2P, PC 1010EUS, PC 1010EUS-UK110, PC 1010PL, PC 1010S, PC 1010UK1, PC 1010UK2**  
 er laget i henhold til gjeldende grunnleggende bestemmelser for helse og sikkerhet i følgende dokumenter:  
**EN ISO 14121-1:2007, EN ISO 3744:1995, EN ISO 4871:2009, EN1012-1:2010, EN 60204-1:2006+A1:2009, EN286-1:1998**  
 Underskrevet av: Chris Klein  
 Stilling: teknisk sjef  
 Dokumentets sted: Senco Brands, Inc.  
 4270 Ivy Pointe Blvd., Cincinnati, Ohio 45245  
 Opprinnelig utstedt: 4 September 2014  
 Autorisert representant:  
 (godkjent for å sette sammen den tekniske filen)  
 Navn: Peter van der Wel  
 Adresse: Senco Brands B.V.  
 Geurdeland 17E, 6673 DR Ardeist, The Netherlands

**1. Senco Professional End User Warranty Policy**

Considering the following constraints Senco underwrites the reliability and the quality of its supplied authorised Senco branded products.

1.1 Senco warrants to the end user that the following products will be free from defects in construction, assembly and material for the warranty period specified below.

Product	Warranty period
Senco ® XP Series-Red Cap, pneumatic tools	Five years
Senco ® XP Series-Black Cap, pneumatic tools	Two years
Senco Pro Series, pneumatic tools	One year
Senco Semi-Pro Series, pneumatic tools	One year
Senco DuraSpin ® Series, electric and battery tools	One year
Senco Cordless battery tools	Two years
Senco batteries and chargers for tools	One year
Senco gas tools	Two years
Senco Reconditioned Products	One year
Senco other tools	One year
Senco Compressors	One year

1.2 The warranty period starts on the day the end user purchases the product and/or 1 year after the tool has been deleted from the product line, whichever date comes first.

1.3 To claim warranty the end user needs to send the defective products or their parts, including the serial number and the original and dated sales receipt or proof of purchase from the original retailer or dealer, freight prepaid to the original retailer or dealer.

1.4 Senco is not obliged to do any repairs or replacements on any products or their parts on site.

1.5 During the warranty period Senco or its distributors will repair or replace defective products or their parts, exclusively or mainly as a result of an imperfection in construction, assembly or material, at Senco's option and expense, subject to the constraints of this warranty policy.

1.6 The repair or replacement of products or their parts under warranty, does in no case lead to prolongation of the warranty period. For every replacement product or part, the remaining original warranty period of the replaced product or part is applicable.

1.7 Senco will become the owner of the products or parts that have been replaced by Senco or its distributors as a result of being compliant to Senco's warranty, without being obligated any compensation in this matter.

1.8 Excluded from the warranty are:

- Normal wear and tear parts, for example rubber o-rings, seals, driver blades, piston stops, piston/driver assemblies, isolators, drive belts, air filters and fuel systems, bits;
- Any imperfection that is a result of or has evolved from the fact that there has not been used clean, dry regulated compressed air and/or the air pressure applied has exceeded the maximum indicated on the tool casting (pneumatic tools);
- Any imperfection that is a result of or has evolved from normal wear, misapplication, abuse/misuse, improper modifications or storage, shipping/transport, accidents, neglect, operation at other than recommended speeds or voltage (electric units only);
- Any imperfection that is a result of or has evolved from explosions, fires and natural disasters, like hurricanes, floods and earthquakes;
- Any imperfection that is a result of or has evolved from not following operating instructions, specifications and / or maintenance schedules. Read the Operator Manual for use, specifications and maintenance instructions;
- Any imperfection that is caused by repairs, modifications to the product or attempts to do so by the end user or any third party;
- Labour charges or loss or damage resulting from improper operation, maintenance or repairs are not covered by this warranty
- Any warranty claims that have been received after the warranty period, as specified in this end user warranty, has expired.

1.9 Additional costs like shipping/transport, special packaging requirements and costs of travel and accommodation, are at the end users expense.

1.10 If a complaint is unfounded, all costs incurred thereby, including handling, inspection, shipping and administrative costs on the side of Senco or its distributors, will be charged to the end user.

1.11 After expiration of the warranty period, all costs for repair or replacement, including handling, inspection, shipping and administrative costs will be charged to the end user.

1.12 Notwithstanding legal limitation periods, the limitation of all claims and appeals against Senco and third parties involved by Senco for the implementation of the agreement is one year.

1.13 If Senco fails to meet this agreement, it will not discharge the end user from the obligations arising under this or any other contract.

1.14 When the warranty terms can not be met, due to for example import or export prohibitions, strikes or other unforeseen circumstances, the warranty period will be extended accordingly.

1.15 Senco's liability is limited to the warranty. Senco is not liable for damage caused by the functioning or non-functioning of the products as delivered, repaired or modified by Senco or its distributors, including but not limited to, production losses, profit losses, reduced working range, commercial losses or consequential damages or indirect damages whatsoever.

## Elektrisk Kompressor

### Parts Reference Guide

NO:RLB-1409

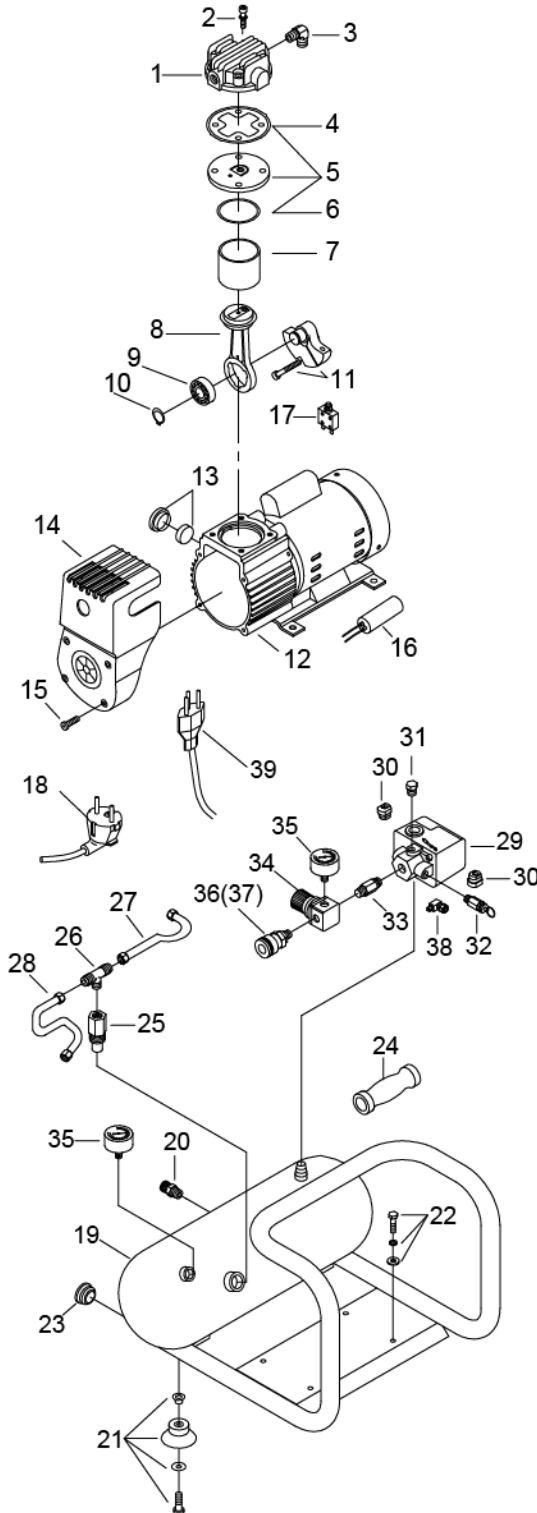

Ref. No.	Description	Part No.	Qty.
1	CYLINDER HEAD	3101063A	1
2	ALLEN BOLT SET	3B01-M05*060V	4
3	EXHAUST ELBOW	2N06-01T02H	1
4	CYLINDER HEAD GASKET	2G01-025H	1
5	EXHAUST VALVE ASSEMBLY	3B11-DC02A	1
6	VALVE SEAT GASKET	2G03-018	1
7	CYLINDER	3201068	1
8	ROD ASSEMBLY	3B3-MB02	1
9	BEARING	2N35-6201ZZC3	1
10	CLIP	2N42-S12	1
11	CRANKSHAFT & BALANCER	3304086	1
12	MOTOR SET	3B8-MB0206S	1
13	AIR FILTER SET	2140026RS	1
14	SHROUD	2428015RS	1
15	BOLT	2B02-FM4*015B	4
16	RUNNING CAPACITOR	2E27-004F4525	1
17	CIRCUIT BREAKER	2E25-01AS	1
18	POWER CABLE (2 PIN)	2E01-029S	1
19	AIR TANK	3401174U	1
20	DRAIN VALVE	2405012	1
21	RUBBER PAD SET	3433011-ARS	4
22	HEXAGON BOLT SET	3B00-FM06*012RS	4
23	PLUG	2N32-W07RS	2
24	GRIP	2432107	1
25	CHECK VALVE	2414033A	1
26	UNLOADING 3-WAY PIPE	2N09-02H01T02H4	1
27	UNLOADING TUBE	3B2-02*190F	1
28	DISCHARGE TUBE	2T02-02*0260RS	1
29	PRESSURE SWITCH	2E21-AA256BPS	1
30	STRAIN RELIEF BUSHING	2E04-008	2
31	PLUG	2N33-009	1
32	PRESSURE RELIEF VALVE	2406021A	1
33	NIPPLE	2N01-058RS	1
34	REGULATOR	2408008RRS	1
35	PRESSURE GAUGE	2D12-15D14BAR	2
36	QUICK COUPLER (FOR PC1010EU ONLY)	07S1/4M-ERS	1
37	QUICK COUPLER (FOR PC1010EU COMBO KIT, PC1010S, 6PR2001N)	07OS1/4M-C	1
38	UNLOADING VALVE	2409015	1
39	POWER CABLE (3 PIN)	2E01-044S	1



# Elektrisk Kompressor

## Bruksvisning

(Översättning Av De  
Ursprungliga Undervisningarna)



# SENCO®

Senco Brands, Inc.  
4270 Ivy Pointe Blvd.  
Cincinnati, OH 45245  
1-800-543-4596  
[www.senco.com](http://www.senco.com)  
EMEA: [www.senco-emea.com](http://www.senco-emea.com)



Säkerhetsanvisningar för denna kompressor finns med i denna handbok.



Läs och gör dig förtrogen med samtliga anvisningar.

PC1010 • Reviderad 11 Mars 2015 (Ersätter 1/24/2013)

## Innehållsförteckning

Introduktion.....	3
Kontroll .....	3
Säkerhetsanvisningar.....	4
Kompressorns Funktioner .....	8
Förberedelser .....	10
Inledande Installation.....	10
Plats .....	10
Elektriskt .....	10
Handhavande .....	11
Kontrollista Innan Du Börjar.....	11
Igångsättning .....	11
Avstängning .....	11
Underhåll .....	11
Felsökning .....	12
Specifikationer.....	14
Försäkran Om Överensstämmelse .....	14
Begränsad Garanti .....	15
Parts Reference Guide.....	16

## Introduktion

Gratulerar till köpet av din nya SENCO® kompressor! Du kan lita på att din SENCO kompressor konstruerats med högsta möjliga precision och noggrannhet. Varje del har testats utförligt av tekniker för att säkerställa kvalitet, hållbarhet och prestanda hos denna kompressor.

Denna bruksanvisning har utarbetats för dig. Genom att läsa och följa de enkla steg för säkerhet, installation, användning och underhåll som finns beskrivna i denna bruksanvisning så får du många års bekymmersfri drift med din nya SENCO kompressor. Innehållet i denna handbok baseras på den senaste produktinformationen som finns tillgänglig vid publiceringstillfället. Tillverkaren förbehåller sig rätten att ändra uppgifter om pris, färg, material, utrustning, specifikationer eller modeller när som helst utan förvarning.



### Viktigt Om Säkerhet!

Säkerhetsanvisningar av typen "FARA, VARNING eller FÖRSIKTIGHET" omges av en "SÄKERHETSANVISNINGSRUTA".

En sådan ruta är används för att beteckna och markera säkerhetsanvisningar som ska följas vid användning av denna kompressor. Dessa säkerhetsanvisningar har "nivåmarkeringsord" som betecknar graden eller nivån på säkerhetsrisken. De "nivåmarkeringsord" som används i denna bruksanvisning är följande:

**Fara:** Betecknar en överhängande fara som KOMMER ATT leda till dödsfall eller allvarlig kroppsskada.

**Varning:** Betecknar en möjlig fara som KAN leda till dödsfall eller allvarlig kroppsskada.

**Försiktighet:** Betecknar en möjlig fara som KAN leda till kroppsskada eller skador på kompressorn.



Symbolerna till vänster är "säkerhetsanvisningssymboler". Dessa symboler används för att uppmärksamma delar eller handhavande som kan medföra fara för dig eller andra personer som använder utrustningen.

**GE ALLTID EN KOPIA AV DENNA BRUKSANVISNING TILL DEN SOM SKA ANVÄNDA UTRUSTNINGEN. LÄS ALLA INSTRUKTIONER I DENNA BRUKSANVISNING OCH ALLA EVENTUELLA INSTRUKTIONER FRÅN TILLVERKARE AV TILLBEHÖRSUTRUSTNING INNAN DU ANVÄNDER KOMPRESSORN. LÄGG SÄRSKILT MÄRKE TILL SÄKERHETSANVISNINGARNA FÖR ATT FÖREBYGGA PERSONSKADOR PÅ ANVÄNDARE.**

## Kontroll

Packa upp kompressorn och skriv in serienumret på raden nedan. Titta efter tecken på tydliga eller dolda fraktskador. Försäkra dig om att alla skadade delar byts ut och att alla mekaniska problem rättas till innan du sätter igång kompressorn.

**SERIENUMMER** \_\_\_\_\_

Ring SENCO's avgiftsfria hjälptelefon om du har frågor eller kommentarer: **1-800-543-4596** eller, e-post: [toolprof@Senco.com](mailto:toolprof@Senco.com)

Ha följande information tillgänglig vid alla servicesamtal:



1. Modellnummer
2. Serienummer
3. Inköpsdatum och försäljningsställe

Senco, 4270 Ivy Pointe Blvd., Cincinnati, OH 45245

## Säkerhetsanvisningar





Läs Alla Säkerhetsanvisningar Innan Du Använder Kompressorn

Fara	Eventuell Följd	Förebyggande Åtgärder
<p><b>Risk För Elektrisk Stöt Eller Att Du Får Livsfarlig Ström Genom Kroppen</b></p>  	<ul style="list-style-type: none"> <li>Allvarlig skada eller dödsfall kan inträffa om kompressorn inte är jordad på rätt sätt. Din kompressor drivs av elektricitet och den kan orsaka att du får en elektrisk stöt eller att du får livsfarlig elektrisk ström genom kroppen, om den inte används på rätt sätt.</li> </ul>	<ul style="list-style-type: none"> <li>Se till att kompressorn är ansluten till ordentligt jordat strömuttag som ger rätt spänning och har en passande säkring.</li> </ul>
	<ul style="list-style-type: none"> <li>Elektrisk stöt kan komma från sladden.</li> </ul>	<ul style="list-style-type: none"> <li>Kontrollera sladden och titta efter tecken på kross-, skär- eller värmeskador. Ersätt en defekt sladd innan du använder kompressorn.</li> <li>Håll alla kopplingar torra och över marken. Låt inte elektriska sladdar ligga i vatten eller i ett sådant läge avatten kan komma i kontakt med dem. Rör inte stickkontakten med våta händer.</li> <li>Ryck inte i den elektriska sladden fört dra ut den från vägguttaget.</li> </ul>
	<ul style="list-style-type: none"> <li>En elektrisk stöt kan inträffa om kompressorn inte används på rätt sätt.</li> </ul>	<ul style="list-style-type: none"> <li>Använd aldrig kompressorn under fuktiga förhållanden eller utomhus när det regnar.</li> <li>Använd aldrig kompressorn när säkerhetsskydden/kåporna är borttagna eller skadade.</li> </ul>
	<ul style="list-style-type: none"> <li>Allvarlig skada eller dödsfall kan inträffa om elektriska reparationer utförs av obehöriga personer.</li> </ul>	<ul style="list-style-type: none"> <li>All elektrisk ledningsdragning eller alla reparationer som utförs på denna kompressor måste utföras av behörig servicepersonal i överensstämmelse med nationella och lokala elektriska regler.</li> <li>Innan du öppnar någon elektrisk kåpa ska du alltid stänga av luftkompressorn, släppa ut övertryck och koppla ur den från nätanslutningen. Låt kompressorn svalna. Lita aldrig på att kompressorn är säker att arbeta med bara för att den inte är igång. Den kan starta igen när som helst.</li> </ul>

## Säkerhetsanvisningar



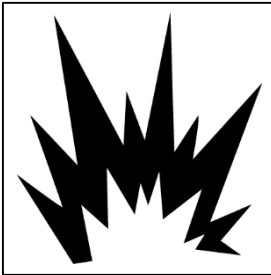

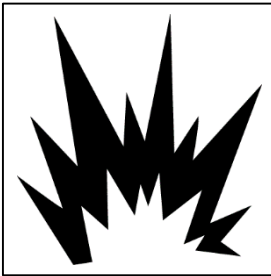

**Läs Alla Säkerhetsanvisningar Innan Du Använder  
Kompressorn**

Fara	Eventuell Följd	Förebyggande Åtgärder
<p style="text-align: center;"><b>Risk För Explosion Eller Brand</b></p> <div style="text-align: center;">     </div>	<ul style="list-style-type: none"> <li>• Allvarlig skada eller dödsfall kan uppstå från normala elektriska gnistor i motorn och från tryckströmställaren.</li>   <li>• Allvarlig skada kan inträffa om någon ventilationsöppning är tilltäppt och orsakar att kompressorn överhettas och börjar brinna.</li> </ul>	<ul style="list-style-type: none"> <li>• Använd alltid kompressorn i ett väl ventilerat utrymme som är fritt från antändbara ångor, pulver, gaser eller andra ämnen.</li> <li>• Om du sprutar med brandfarligt material ska du ställa kompressorn på minst 6 meters avstånd från prutningsområdet. (En extra slang kan behövas.)</li>   <li>• Ställ aldrig föremål mot eller ovanpå kompressorn. Installera kompressorn på minst 30 centimeters avstånd från väggar eller hinder som kan begränsa ordentlig ventilation.</li> </ul>
<p style="text-align: center;"><b>Risk För Sönderbrotning</b></p> <div style="text-align: center;">  </div>	<ul style="list-style-type: none"> <li>• Allvarlig skada eller dödsfall kan uppstå vid en explosion i lufttanken om den inte sköts ordentligt.</li>   <li>• Allvarlig skada kan inträffa om kompressorn inte fungerar som den ska eller om tillbehör exploderar om felaktiga komponenter, anslutningar eller tillbehör används till kompressorn.</li> </ul>	<ul style="list-style-type: none"> <li>• Töm lufttanken varje dag efter varje gång som du har använt den för att förhindra att fukt bildas i lufttanken.</li> <li>• Om det bildas en läcka i lufttanken ska du genast byta ut den. Reparera, svetsa eller förändra aldrig lufttanken eller dess kopplingar.</li> <li>• Justera aldrig fabriksinställda tryck.</li>   <li>• Överskrid aldrig tillverkarens maximalt tillåtna tryckkapacitet för kopplingar.</li> <li>• På grund av extrem värme ska du inte använda plaströr eller lödtennsskarvar för en tryckledning.</li> <li>• Använd aldrig kompressorn för att blåsa upp små föremål med lågt tryck, såsom leksaker.</li> <li>• Använd endast originaldelar från SENCO vid reparation av din luftkompressor.</li> </ul>

## Säkerhetsanvisningar

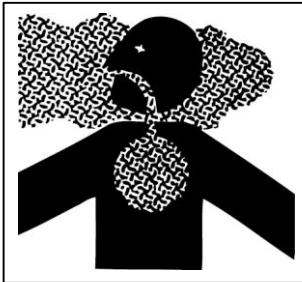



**Läs Alla Säkerhetsanvisningar Innan Du Använder Kompressorn**

Fara	Eventuell Följd	Förebyggande Åtgärder
<p style="text-align: center;"><b>Risk För Andningsorganen</b></p> 	<ul style="list-style-type: none"> <li>• Allvarlig skada eller dödsfall kan inträffa om du inandas tryckluft. Luftströmmen kan innehålla koloxid, giftiga ångor eller fasta partiklar.</li> <li>• Sprutade material såsom färg, lösningsmedel för färg, färgborttagningsmedel, insektpulver, ogräsbekämpningsmedel, etc. innehåller farliga ångor och gifter.</li> </ul>	<ul style="list-style-type: none"> <li>• Inandas aldrig luft från kompressorn varken direkt eller genom en andningsanordning som kopplats samman med kompressorn.</li> <li>• Använd kompressorn endast i ett väl ventilerat utrymme. Följ alla säkerhetsinstruktioner som följer med de material som du sprutar. Det kan vara nödvändigt att använda en gasmask när du arbetar med vissa material.</li> </ul>
<p style="text-align: center;"><b>Risk För Brandskador</b></p> 	<ul style="list-style-type: none"> <li>• Allvarlig skada kan uppstå av att röra vid exponerade metalldelar. Dessa områden kan förbli varma ett tag efter det att kompressorn har stängts av.</li> </ul>	<ul style="list-style-type: none"> <li>• Låt aldrig någon kroppsdel eller andra material komma i kontakt med några exponerade metalldelar i kompressorn, motor- eller rörkonstruktion.</li> </ul>
<p style="text-align: center;"><b>Risk För Flygande Föremål</b></p> 	<ul style="list-style-type: none"> <li>• Vävnadsskador kan uppstå av tryckluftströmmen.</li> </ul>	<ul style="list-style-type: none"> <li>• Bär alltid skyddsglasögon i enlighet med skyddsbestämmelserna för att skydda ögonen mot flygande material.</li> <li>• Rikta aldrig luftströmmen mot någon kroppsdel, varken din egen, någon annans eller något djurs.</li> <li>• Lämna aldrig en tryckluftsfyllt kompressor utan tillsyn. Stäng av kompressorn och släpp ut övertrycket innan du börjar med underhållsarbete, kopplar in verktyg eller tillbehör.</li> </ul>
<p style="text-align: center;"><b>Använd Alltid Ögonskydd</b></p> 	<ul style="list-style-type: none"> <li>• Allvarlig skada kan uppstå från löst material som drivs framåt i hög hastighet av tryckluftströmmen.</li> </ul>	<ul style="list-style-type: none"> <li>• Håll alltid ett säkerhetsavstånd från människor och djur när du använder kompressorn.</li> <li>• Flytta inte kompressorn medan lufttanken är trycksatt. Försök inte aflytta kompressorn genom att dra i slangen.</li> </ul>

## Säkerhetsanvisningar



**Läs Alla Säkerhetsanvisningar Innan Du Använder Kompressorn**

Fara	Eventuell Följd	Förebyggande Åtgärder
<p><b>Risk På Grund Av Rörliga Delar</b></p>  <p><b>Enheten Kan Starta Utan Varning</b></p> 	<ul style="list-style-type: none"> <li>• Risk för kroppsskada från rörliga delar. Denna kompressor går automatiskt igång när tryckreglaget är i läget <b>ON (1)/Auto</b>.</li> <li>• Risk för skada vid vårdslös användning.</li> </ul>	<ul style="list-style-type: none"> <li>• Stäng alltid av kompressorn när du inte använder den. Släpp ut övertryck från luftslangen och koppla ur det elektriska vägguttaget innan du påbörjar underhållsarbete. Alla reparationer på kompressorn ska göras av behörig servicepersonal. Anta aldrig att kompressorn är säkert att arbeta med bara därför att den inte är igång. Den kan starta igen som helst!</li> <li>• Använd den inte utan skyddande kåpor/anordningar. Byt ut skadade kåpor/anordningar innan du använder kompressorn.</li> </ul>
<p><b>Risk På Grund Av Vårdslöshet</b></p> 		<ul style="list-style-type: none"> <li>• Låt aldrig barn eller ungdomar använda denna kompressor!</li> <li>• Var uppmärksam - titta på vad du gör.</li> <li>• Använd inte kompressorn när du är trött eller påverkad av alkohol eller droger.</li> <li>• Se till att du vet hur man stänger av kompressorn. Bekanta dig noga med reglagen.</li> </ul>
<p><b>Risk För Skada På Kompressorn</b></p>	<ul style="list-style-type: none"> <li>• Risk för större reparation.</li> </ul>	<ul style="list-style-type: none"> <li>• Använd inte kompressorn utan ett luftfilter.</li> <li>• Använd inte kompressorn i en korrosiv miljö.</li> <li>• Använd alltid denna kompressor i stabilt, säkert läge för att förhindra att kompressorn faller ner.</li> <li>• Följ alla underhållsinstruktioner som listas i denna bruksanvisning.</li> </ul>

**! SPARA DESSA INSTRUKTIONER !**

## Kompressorns Funktioner

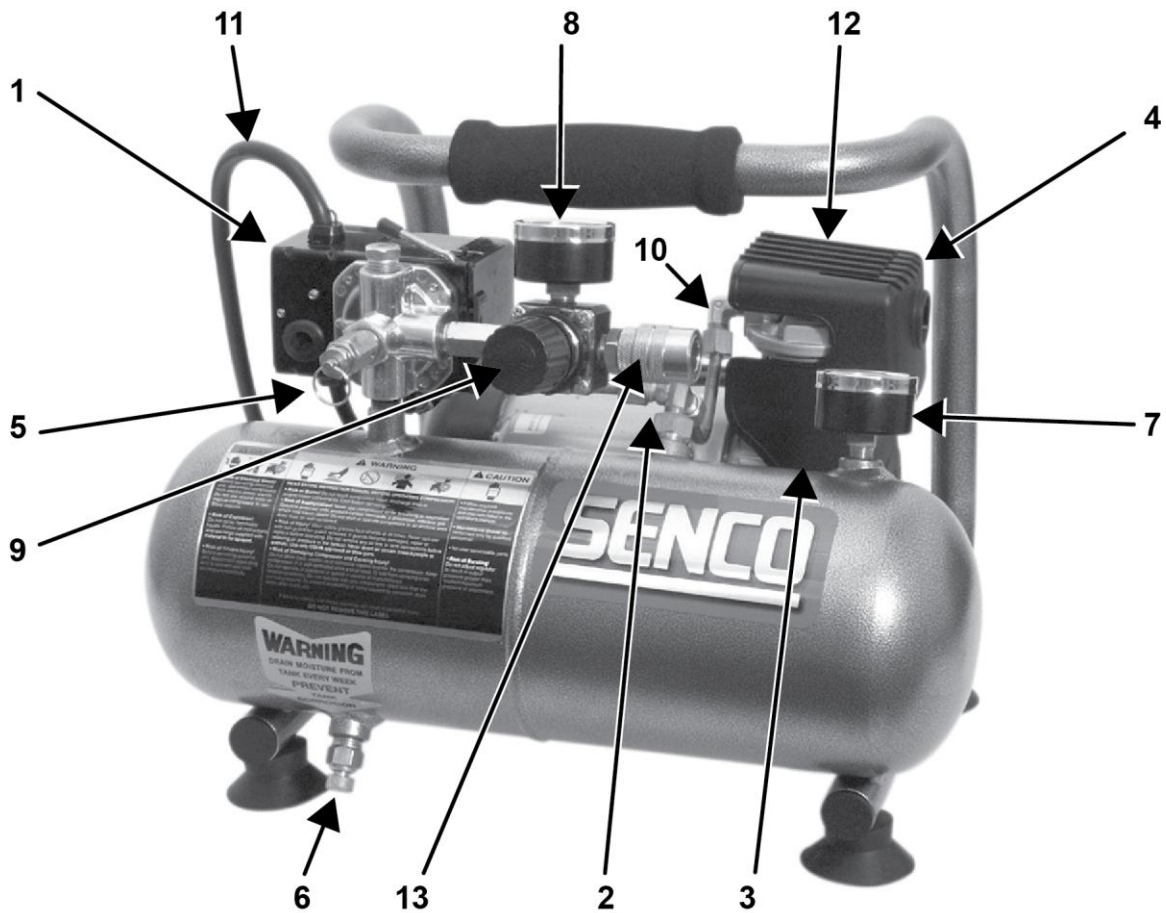

1.	Motor/Tryckreglage
2.	Värmesäkring / Nollställning
3.	Filter För Luftinsug
4.	Kompressorpump
5.	Säkerhetsventil
6.	Lufttankens Tömningsventil
7.	Tankens Tryckmätare
8.	Tryckmätare För Utlopp
9.	Tryckregulator
10.	Tryckledning
11.	Elektrisk Sladd
12.	Ventilationsöppningar / Skyddshölje
13.	Snabbfrånkoppling



## Kompressorns Funktioner

**1) Motor/Tryckreglage:** Detta reglage används för att starta eller stänga av kompressorn. När du flyttar reglaget till läget **ON (1)** förses tryckreglaget automatiskt med ström vilket låter motorn starta när trycket i lufttanken är under det fabriksinställda inkopplingstrycket. När den är i läget **ON (1)** stannar tryckreglaget motorn när trycket i lufttanken når det fabriksinställda frångkopplingstrycket. Av säkerhetsskäl har detta reglage även en tryckutlösningsventil som sitter på sidan av reglaget och som konstruerats för att automatiskt släppa ut tryckluft från kompressorns pump och dess tryckledning när kompressorn når frångkopplingstryck eller stängs av. Detta låter motorn starta igen utan hinder. När du flyttar reglaget till läget **Off (0)** kopplas strömmen bort från tryckreglaget och kompressorn stannar.

**2) Överbelastning Av Motorn:** Motorn är försedd med en automatsäkring, som är fast på pumpen. Vid för hög ampere utlöses automatsäkringen för att skydda motorn och kontrollpanelen. Återställ automatsäkringen genom att trycka tillbaka den svarta plastspaken i höljet. Återställ strömbrytaren om säkringen har lösts ut.

**3) Filter För Luftinsug:** Detta filter är utformat för att rena luft som kommer in i pumpen. För att säkerställa att pumpen kontinuerligt får ren, sval, torr luft måste filtret alltid vara rent och ventilationsöppningarna vara fria från hinder. Filtret kan tas bort för att rengöras med varmt tvålsvatten. Skölj filtret och låt det lufttorka.

**4) Kompressorump:** Kolven i cylindern rör sig för att komprimera luft. På nedåtgående slag dras luft in genom luftinsugsventilen medan utblåsningsventilen förblir stängd. På uppåtgående slag komprimeras luften och insugsventilen stängs och komprimerad luft tvingas ut genom utblåsningsventilen in i tryckledningen genom backventilen och in i lufttanken.

**5) Säkerhetsventil:** Denna ventil är utformad för att förhindra maskinavbrott genom att släppa ut övertryck från systemet när den tryckluften når en förutbestämd nivå. Ventilen är förinställd av tillverkaren och får inte ändras på något sätt. Dra i ringen för att kontrollera att ventilen fungerar ordentligt. Tryckluft ska släppas ut. När ringen släpps tillbaka kommer den att återställas.

**6) Lufttankens Tömningsventil:** Tömningsventilen används för att ta bort fukt från lufttanken(lufttankarna) efter det att kompressorn har stängts av. **Försök ALDRIG att öppna tömningsventilen när mer än 0.7 kPa (10 PSI) lufttryck är i lufttanken!** För att öppna tömningsventilen ska du vrida ratten moturs. Luta tanken för att säkerställa att all kondens töms ut genom ventilen.

**7) Lufttankens Tryckmätare:** Lufttankens tryckmätare anger det lufttryck som finns kvar i lufttanken (lufttankarna).

**8) Tryckmätare För Utlopp:** Utloppets tryckmätare anger det lufttryck som finns tillgängligt vid regulatorns utlopp. Detta tryck regleras av regulatorn och det är alltid mindre än eller lika stort som trycket i lufttanken.

**9) Tryckregulator:** Lufttrycket som kommer från lufttanken regleras med ratten. Vrid tryckregulatorns ratt medurs för att öka utloppstrycket och moturs för att minska utlopps-trycket. Följ apparatens bruksanvisning för rekommenderat tryck.

**10) Tryckledning:** Kom ihåg att tryckledningen är mycket varm. **Varm yta - Ta ej bort skyddskåpa. Hög temperatur efter kontinuerlig drift.**

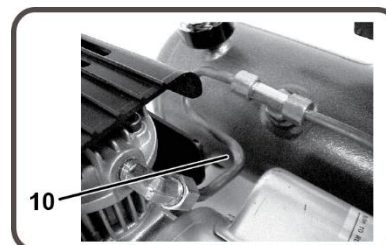
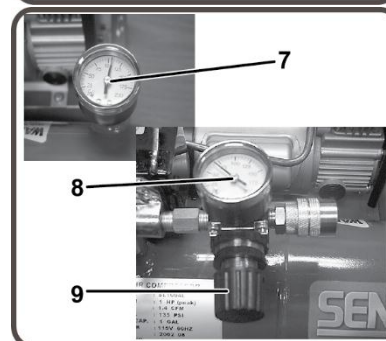
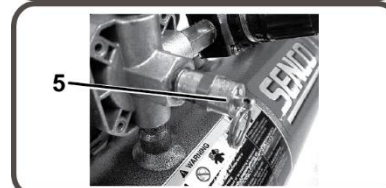
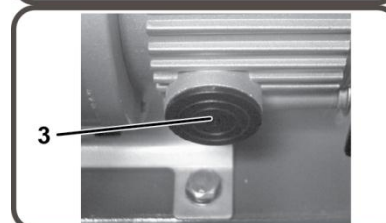
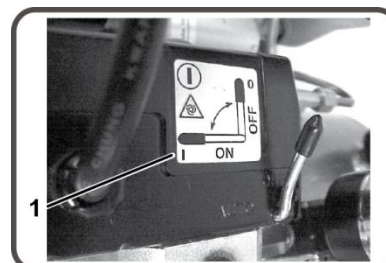

## Förberedelser

### Inledande Installation

1. Läs säkerhetsanvisningarna innan du installerar kompressorn.

### Plats

**Försiktighet** För att undvika att skada kompressorn ska du inte luta den mer än 10 på tvären eller längden.

1. Ställ kompressorn på åtminstone 30 centimeters avstånd från objekt som kan förhindra ordentlig ventilation.

Ställ inte kompressorn på en plats:

- Där det finns spår av olje- eller gasläckage.
- Där antändbara ångor eller ämnen kan finnas.

### Varning



Allvarlig skada eller dödsfall kan inträffa om gnistor från motor och tryckreglage kommer i kontakt med antändbara ångor, brandfarliga pulver, gaser eller andra brandfarliga ämnen. När du använder kompressorn för sprutmålning ska du ställa den så långt från arbetsområdet som möjligt genom att använda extra slangar och inte förlängningssladdar.

- Där temperaturen sjunker under 0C eller överstiger 40C.
- Där extremt smutsig luft eller vatten kan dras in i kompressorn.

### Elektriskt

### Fara



Felaktig sammankoppling av jordledningen kan resultera i risk för stöt eller att man får livsfarlig elektricitet genom kroppen. Fråga en behörig elektriker eller servicepersonal om du är osäker på om strömuttaget är ordentligt jordat. Använd inte någon typ av adapter med denna produkt. Om sladden eller kontakten behöver repareras eller ersättas ska du inte koppla jordledningen till något av kontaktelementen. Ledningen som är grön med eller utan gula streck är jordledningen.

### Varning



Denna produkt måste jordas. Om funktionsstörning eller haveri inträffar är jordledningen en väg för den elektriska strömmen som minskar risken för elektriska stötar. Denna produkt har en jordande kabel och en jordad stickkontakt. Kontakten måste sättas i ett lämpligt vägguttag som har installerats ordentligt och jordats i enlighet med alla lokala regler och bestämmelser.

1. SENCO® REKOMMENDERAR INTE ATT DU ANVÄNDER FÖRLÄNGNINGSSLADDAR eftersom det kan skapa energiförlust och överhettning av motorn. Vi rekommenderar att du använder en extraslang hellre än en förlängningssladd. Om du inte kan undvika att använda en förlängningssladd ska du koppla den till en jordfelsbrytare eller ett skyddat uttag.

När du använder en förlängningssladd ska du tänka på följande:

Kabellängd	Ledningsarea
Upp till 8 meter	3.31 mm <sup>2</sup>
Upp till 30 meter	5.27 mm <sup>2</sup>
Upp till 50 meter	8.35 mm <sup>2</sup>
Upp till 75 meter	13.30 mm <sup>2</sup>

Använd endast förlängningssladdar som är dimensionerade att klara produktens belastning eller högre. Använd inte skadade förlängningssladdar. Undersök sladden innan du använder den och byt ut den om den är skadad. Missköt inte förlängningssladden och ryck inte i någon sladd för att koppla ur den. Håll sladden borta från värme och skarpa kanter. Stäng alltid av kompressorn innan du drar ut kontakten.

## Handhavande

### Kontrollista Innan Du Börjar

1. Ta bort all fukt i kompressorns lufttank. Ta bort överflödigt tryck med ett tryckluftsverktyg och öppna sedan lufttankens tömningsventil i botten på lufttanken. Avlägsna överflödigt tryck genom att dra i avlastningsventilens ring eller öppna lufttankens avtappningsventil i tankens underkant. Stäng ordentligt när du har tömt.



**Varning: Risk för kroppsskada. Försök ALDRIG att öppna tömningsventilen när när mer än 70.0 kPa lufttryck är i lufttanken!**

2. Se till att kompressorns motorströmställare är i läget **OFF (0)**.
3. Se till att alla säkerhetsventiler fungerar korrekt.
4. Se till att alla skydd och kåpor är på plats och säkert monterade.

### Igångsättning

1. Försäkra dig om att spaken på tryckreglaget är i läget **OFF (0)**.
2. Se till att alla säkerhetsventiler fungerar korrekt.
3. Sätt spaken på tryckreglaget i läget **ON (1)**.
4. **Start** låter kompressorn börja arbeta upp tryck i lufttankarna och **Stop** när rätt tryck har uppnåtts. När trycket sjunker efterhand som du använder kompressorn kommer **Start** att bygga upp trycket igen.
5. Ställ in trycket genom att vrida tryckregulatorns ratt moturs om du vill ha mindre tryck och medurs om du vill ha mer tryck.
6. Om du lägger märke till något ovanligt ljud eller ovanlig vibration ska du stänga av kompressorn och läsa "Felsökning."

### Avstängning

1. När du vill stänga av kompressorn ska du flytta spaken på tryckreglaget till läge **OFF (0)**. Stäng ALDRIG av kompressorn genom att dra ut sladden ur uttaget. Då kan du riskera att få livsfarlig ström genom kroppen.
2. Släpp ut luften ur tanken genom att släppa ut luft med hjälp av ett inkopplat tryckluftsverktyg eller genom att dra i ringen till säkerhetsventilen.
3. När trycket i lufttankarna understiger 70.0 kPa ska du öppna tömningsventilen under varje lufttank för att tömma ut all fukt.
4. Låt kompressorn svalna.
5. Torka kompressorn ren och förvara den på ett säkert ställe där det inte fryser.

## Underhåll

Läs bruksanvisningen innan du börjar med underhållet. Följande rutiner måste utföras när du stannar kompressorn för att utföra underhåll eller service.

1. xxx.



**Varning: Anta aldrig att kompressorn är säker att arbeta med bara därför att den inte är igång. Den kan starta igen när som helst!**

2. Koppla ur sladden från strömuttaget.
3. Öppna alla avtappningsventiler.
4. Vänta tills kompressorn har svalnat innan du påbörjar service.

Underhållstabell			
Rutiner	Dagligen	Varje Vecka	Varje Månad
Tappa ur kondens i lufttank(ar)	X		
Kontrollera ovanliga oljud/vibrationer	X		
Titta efter luftläckor	X		
Kontrollera luftfiltret		X	
Rengör kompressorn på utsidan		X	
Kontrollera säkerhetsventilen			X

## Felsökning

<b>Tecken 1. Motorn går inte eller startar inte.</b>	
<b>Sannolik Orsak</b>	<b>Åtgärd</b>
<ul style="list-style-type: none"> <li>• Sladden är inte ansluten.</li> </ul>	<ul style="list-style-type: none"> <li>• Anslut sladden till jordat uttag.</li> </ul>
<ul style="list-style-type: none"> <li>• Reglaget för motor/tryck är i läge <b>OFF (0)</b>.</li> </ul>	<ul style="list-style-type: none"> <li>• Flytta reglaget till läge <b>ON (1)</b>.</li> </ul>
<ul style="list-style-type: none"> <li>• Motorns värmesäkring för överhettning har utlösts.</li> </ul>	<ul style="list-style-type: none"> <li>• Stäng av kompressorn, vänta tills motorn har svalnat, kontrollera sedan motorns strömbrytare.</li> </ul>
<ul style="list-style-type: none"> <li>• En säkring eller jordfelsbrytare har utlösts.</li> </ul>	<ul style="list-style-type: none"> <li>• Ersätt säkringen eller nollställ jordfelsbrytaren.</li> <li>• Kontrollera att säkringen har rätt strömstyrka.</li> <li>• Kontrollera lågspänningsförhållanden.</li> <li>• Koppla ur alla andra elektriska apparater från strömkretsen eller använd kompressorn i en separat grenkoppling.</li> </ul>
<ul style="list-style-type: none"> <li>• Fel ledningsarea eller längd på förlängningssladd.</li> </ul>	<ul style="list-style-type: none"> <li>• Titta i tabellen på sidan 10 för att få reda på rätt ledningsarea och sladdlängd.</li> </ul>
<ul style="list-style-type: none"> <li>• Trycket i lufttanken överskrider inkopplingstrycket på motor/tryckreglaget.</li> </ul>	<ul style="list-style-type: none"> <li>• Motorn startar automatiskt när trycket i lufttanken faller under inkopplingstrycket på motor/tryckreglaget.</li> </ul>
<ul style="list-style-type: none"> <li>• Tryckventilen på motorn/tryckreglaget har inte utjämnat trycket i pumpen.</li> </ul>	<ul style="list-style-type: none"> <li>• Släpp ut övertryck genom att flytta reglaget till läge <b>OFF (0)</b>.</li> </ul>
<ul style="list-style-type: none"> <li>• Defekt motor, motorkondensator, reglage för motor/tryck eller strypventil.</li> </ul>	<ul style="list-style-type: none"> <li>• Kontakta Sencos kundservice.</li> </ul>
<b>Tecken 2. När läget är Start/Stop går motorn utan avbrott.</b>	
<b>Sannolik Orsak</b>	<b>Åtgärd</b>
<ul style="list-style-type: none"> <li>• Motor/tryckreglaget stänger inte av motorn när kompressorn når frångkopplingstryck och säkerhetsventilen aktiveras.</li> </ul>	<ul style="list-style-type: none"> <li>• Flytta reglaget för motor/tryck till läge <b>OFF (0)</b>. Om motorn inte stängs av ska du koppla ur kompressorn. Om el-kontakterna är sammansvetsade ska du byta ut tryckreglaget.</li> </ul>
<ul style="list-style-type: none"> <li>• Kompressorn är feldimensionerad.</li> </ul>	<ul style="list-style-type: none"> <li>• Begränsa lufttrycket till kompressorns kapacitet. Använd antingen ett mindre verktyg eller en större kompressor.</li> </ul>
<b>Tecken 3. Det läcker ut luft vid motor/tryckreglagets säkerhetsventil när motorn har stannat.</b>	
<b>Sannolik Orsak</b>	<b>Åtgärd</b>
<ul style="list-style-type: none"> <li>• Backventilen har fastnat i öppet läge.</li> </ul>	<ul style="list-style-type: none"> <li>• Ta bort, rengör eller</li> </ul>
<b>Tecken 4. Det läcker ut luft vid motor/tryckreglagets säkerhetsventil medan motorn fortfarande är på.</b>	
<b>Sannolik Orsak</b>	<b>Åtgärd</b>
<ul style="list-style-type: none"> <li>• Trasigt motor/tryckreglage.</li> </ul>	<ul style="list-style-type: none"> <li>• Ersätt.</li> </ul>
<b>Tecken 5. Det läcker ut luft från säkerhetsventilen.</b>	
<b>Sannolik Orsak</b>	<b>Åtgärd</b>
<ul style="list-style-type: none"> <li>• Möjligen en trasig säkerhetsventil.</li> </ul>	<ul style="list-style-type: none"> <li>• Aktivera säkerhetsventilen manuellt genom att dra i ringen.</li> </ul>
<ul style="list-style-type: none"> <li>• För högt tryck i lufttanken.</li> </ul>	<ul style="list-style-type: none"> <li>• Om den fortfarande läcker ska den bytas ut. Trasigt motor/tryckreglage. Ersätt.</li> </ul>

## Felsökning

### Tecken 6. Det läcker ut luft vid beslagen.

Sannolik Orsak	Åtgärd
<ul style="list-style-type: none"><li>Beslagen är inte tillräckligt åtdragna.</li></ul>	<ul style="list-style-type: none"><li>Dra åt beslag där du kan höra att luft läcker ut. Kontrollera beslagen med tvålvattenlösning. Dra inte åt för mycket.</li></ul>

### Tecken 7. Läckage från lufttanken.

Sannolik Orsak	Åtgärd
<ul style="list-style-type: none"><li>Trasig eller rostig lufttank.</li></ul>	<ul style="list-style-type: none"><li>Lufttanken måste bytas ut. Försök inte att reparera tanken! Reparera eller modifiera ej.</li></ul>

### Tecken 8. Det läcker ut luft från insugsfiltret.

Sannolik Orsak	Åtgärd
<ul style="list-style-type: none"><li>Skadad insugsventil.</li></ul>	<ul style="list-style-type: none"><li>Kontakta SENCO kundservice.</li></ul>

### Tecken 9. Otillräckligt tryck vid luftverktyget eller tillbehöret.

Sannolik Orsak	Åtgärd
<ul style="list-style-type: none"><li>Regulatorns ratt är inte inställd på tillräckligt högt tryck eller så är regulatorn trasig.</li></ul>	<ul style="list-style-type: none"><li>Justera regulatorratten till rätt inställning eller ersätt.</li></ul>
<ul style="list-style-type: none"><li>Tilltäppt luftinsugsfilter.</li></ul>	<ul style="list-style-type: none"><li>Rengör.</li></ul>
<ul style="list-style-type: none"><li>Det läcker ut luft.</li></ul>	<ul style="list-style-type: none"><li>Kontrollera läckor och reparera.</li></ul>
<ul style="list-style-type: none"><li>Kompressorn är inte tillräckligt stor för de specifikationer som krävs.</li></ul>	<ul style="list-style-type: none"><li>Kontrollera vad tillbehöret kräver. Om det är högre än kompressorns flöde eller tryckkapacitet behöver du en större kompressor.</li></ul>

### Tecken 10. Kompressorn ger inte tillräckligt med luft.

Sannolik Orsak	Åtgärd
<ul style="list-style-type: none"><li>Tilltäppt luftinsugsfilter.</li></ul>	<ul style="list-style-type: none"><li>Rengör.</li></ul>
<ul style="list-style-type: none"><li>Trasig ventil.</li></ul>	<ul style="list-style-type: none"><li>Töm lufttanken och mät den tid det tar att uppnå fullt tryck. Jämför med specifikationer. Om den är lägre ska du ta bort pumpen och kontrollera ventilbrickan. Rengör eller ersätt.</li></ul>

### Tecken 11. Fukt i ledningsluften.

Sannolik Orsak	Åtgärd
<ul style="list-style-type: none"><li>Kondens i lufttanken som orsakas av hög luftfuktighet eller att kompressorn inte har gått tillräckligt länge.</li></ul>	<ul style="list-style-type: none"><li>Töm lufttanken varje gång du har använt den. Töm lufttanken oftare vid fuktig väderlek och använd ett filter.</li></ul>

## Specifikationer

Modellnummer PC 1010EU		
<b>Motor</b>	Effekt	0.5 HP (peak) / 0.3 KW
	Spänning	230V
	Strömstyrka	2A
	Hertz	50 Hz
	Antal faser	1 (en)
	Varvtal	2850
<b>Kompressorpump</b>	Antal cylindrar	1
	Kompressionskammare	1
	Vevhus	Aluminium
	Lager	Kullager
	Cylinder	Aluminium
	Ventiler	Enkelblad
	Lock	Aluminium
	Filter	Insatstyp
<b>Motor/tryckreglage inställning</b>	Frånkoppling	8.6 bar (125 PSI)
	Inkoppling	6.6 bar (95 PSI)
	Reglage	ON (1) / OFF (0)
<b>Lufttank</b>	Kapacitet	3.8 Liter(1 Gallon)
<b>Prestanda</b>	L/Min Luftflöde	32 (1.1 CFM)
	L/Min @ 2.8 bar	17 (0.6 CFM @ 40 PSI)
	L/Min @ 6.2 bar	10 (0.35 CFM @ 90 PSI)
	L/Min @ 6.9 bar	9 (0.31 CFM @ 100 PSI)
	Maximalt tryck	8.6 bar (125 PSIG)
	Tid till fullt tryck: 0-9 bar	160 sekunder
	Återhämtningstid: 7-9 bar	48 sekunder
<b>Vikt</b>	Netto	9.1 kg
<b>Dimensioner</b>	LxBxH	36 x 33 x 25 cm
<b>Noise</b>	Measured sound power level (dB)	78 dBA
	Guaranteed sound power level (dB)	81 dBA

## Försäkran Om Överensstämmelse

Vi, Senco Brands, Inc.  
 med adress 4270 Ivy Pointe Blvd., Cincinnati, Ohio 45245  
 förklarar i enlighet med följande direktiv:  
**Machindirektiv 2006/42/EG**  
**Pressure Vessel Directive 2009/105/EC.**  
**EMC Directive 2004/108/EC**  
**Low Voltage Directive 2006/95/EC**  
**RoHS Directive 2011/65/EU**  
**Noise Emission Directive 2005/88/EC**  
 och under vårt eget ansvar att: Modell(er):  
**PC 1010 EU, PC 1010EU-2P, PC 1010EUS, PC 1010EUS-UK110,**  
**PC 1010PL, PC 1010S, PC 1010UK1, PC 1010UK2**  
 uppfyller gällande hälso- och säkerhetsföreskrifter angivna i följande  
 document:  
**EN ISO 14121-1:2007, EN ISO 3744:1995, EN ISO 4871:2009,**  
**EN1012-1:2010, EN 60204-1:2006+A1:2009, EN286-1:1998**  
 Undertecknat av: Chris Klein  
 Position: Director of Engineering  
 Plats för konformitetsbeträffelsen: Senco Brands, Inc.  
 4270 Ivy Pointe Blvd., Cincinnati, Ohio 45245  
 Originalt utställt: 4 September 2014  
 Auktoriserad representant:  
 (auktoriserad att sammanställa det tekniska registret)  
 Namn: Peter van der Wel  
 Adress: Senco Brands B.V.  
 Geurdeland 17E, 6673 DR Arnhem, The Netherlands

**1. Senco Professional End User Warranty Policy**

Considering the following constraints Senco underwrites the reliability and the quality of its supplied authorised Senco branded products.

1.1 Senco warrants to the end user that the following products will be free from defects in construction, assembly and material for the warranty period specified below.

Product	Warranty period
Senco ® XP Series-Red Cap, pneumatic tools	Five years
Senco ® XP Series-Black Cap, pneumatic tools	Two years
Senco Pro Series, pneumatic tools	One year
Senco Semi-Pro Series, pneumatic tools	One year
Senco DuraSpin ® Series, electric and battery tools	One year
Senco Cordless battery tools	Two years
Senco batteries and chargers for tools	One year
Senco gas tools	Two years
Senco Reconditioned Products	One year
Senco other tools	One year
Senco Compressors	One year

1.2 The warranty period starts on the day the end user purchases the product and/or 1 year after the tool has been deleted from the product line, whichever date comes first.

1.3 To claim warranty the end user needs to send the defective products or their parts, including the serial number and the original and dated sales receipt or proof of purchase from the original retailer or dealer, freight prepaid to the original retailer or dealer.

1.4 Senco is not obliged to do any repairs or replacements on any products or their parts on site.

1.5 During the warranty period Senco or its distributors will repair or replace defective products or their parts, exclusively or mainly as a result of an imperfection in construction, assembly or material, at Senco's option and expense, subject to the constraints of this warranty policy.

1.6 The repair or replacement of products or their parts under warranty, does in no case lead to prolongation of the warranty period. For every replacement product or part, the remaining original warranty period of the replaced product or part is applicable.

1.7 Senco will become the owner of the products or parts that have been replaced by Senco or its distributors as a result of being compliant to Senco's warranty, without being obligated any compensation in this matter.

1.8 Excluded from the warranty are:

- Normal wear and tear parts, for example rubber o-rings, seals, driver blades, piston stops, piston/driver assemblies, isolators, drive belts, air filters and fuel systems, bits;
- Any imperfection that is a result of or has evolved from the fact that there has not been used clean, dry regulated compressed air and/or the air pressure applied has exceeded the maximum indicated on the tool casting (pneumatic tools);
- Any imperfection that is a result of or has evolved from normal wear, misapplication, abuse/misuse, improper modifications or storage, shipping/transport, accidents, neglect, operation at other than recommended speeds or voltage (electric units only);
- Any imperfection that is a result of or has evolved from explosions, fires and natural disasters, like hurricanes, floods and earthquakes;
- Any imperfection that is a result of or has evolved from not following operating instructions, specifications and / or maintenance schedules. Read the Operator Manual for use, specifications and maintenance instructions;
- Any imperfection that is caused by repairs, modifications to the product or attempts to do so by the end user or any third party;
- Labour charges or loss or damage resulting from improper operation, maintenance or repairs are not covered by this warranty
- Any warranty claims that have been received after the warranty period, as specified in this end user warranty, has expired.

1.9 Additional costs like shipping/transport, special packaging requirements and costs of travel and accommodation, are at the end users expense.

1.10 If a complaint is unfounded, all costs incurred thereby, including handling, inspection, shipping and administrative costs on the side of Senco or its distributors, will be charged to the end user.

1.11 After expiration of the warranty period, all costs for repair or replacement, including handling, inspection, shipping and administrative costs will be charged to the end user.

1.12 Notwithstanding legal limitation periods, the limitation of all claims and appeals against Senco and third parties involved by Senco for the implementation of the agreement is one year.

1.13 If Senco fails to meet this agreement, it will not discharge the end user from the obligations arising under this or any other contract.

1.14 When the warranty terms can not be met, due to for example import or export prohibitions, strikes or other unforeseen circumstances, the warranty period will be extended accordingly.

1.15 Senco's liability is limited to the warranty. Senco is not liable for damage caused by the functioning or non-functioning of the products as delivered, repaired or modified by Senco or its distributors, including but not limited to, production losses, profit losses, reduced working range, commercial losses or consequential damages or indirect damages whatsoever.

## Elektrisk Kompressor

### Parts Reference Guide

NO:RLB-1409

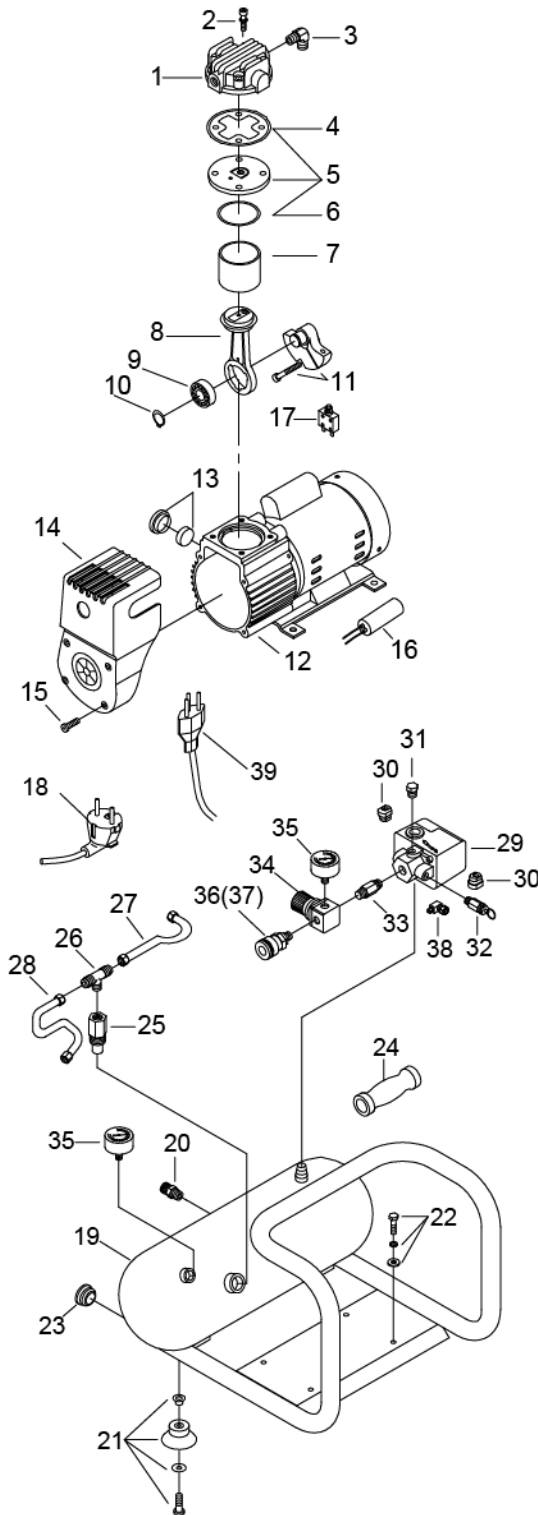

Ref. No.	Description	Part No.	Qty.
1	CYLINDER HEAD	3101063A	1
2	ALLEN BOLT SET	3B01-M05*060V	4
3	EXHAUST ELBOW	2N06-01T02H	1
4	CYLINDER HEAD GASKET	2G01-025H	1
5	EXHAUST VALVE ASSEMBLY	3B11-DC02A	1
6	VALVE SEAT GASKET	2G03-018	1
7	CYLINDER	3201068	1
8	ROD ASSEMBLY	3B3-MB02	1
9	BEARING	2N35-6201ZZC3	1
10	CLIP	2N42-S12	1
11	CRANKSHAFT & BALANCER	3304086	1
12	MOTOR SET	3B8-MB0206S	1
13	AIR FILTER SET	2140026RS	1
14	SHROUD	2428015RS	1
15	BOLT	2B02-FM4*015B	4
16	RUNNING CAPACITOR	2E27-004F4525	1
17	CIRCUIT BREAKER	2E25-01AS	1
18	POWER CABLE (2 PIN)	2E01-029S	1
19	AIR TANK	3401174U	1
20	DRAIN VALVE	2405012	1
21	RUBBER PAD SET	3433011-ARS	4
22	HEXAGON BOLT SET	3B00-FM06*012RS	4
23	PLUG	2N32-W07RS	2
24	GRIP	2432107	1
25	CHECK VALVE	2414033A	1
26	UNLOADING 3-WAY PIPE	2N09-02H01T02H4	1
27	UNLOADING TUBE	3B2-02*190F	1
28	DISCHARGE TUBE	2T02-02*0260RS	1
29	PRESSURE SWITCH	2E21-AA256BPS	1
30	STRAIN RELIEF BUSHING	2E04-008	2
31	PLUG	2N33-009	1
32	PRESSURE RELIEF VALVE	2406021A	1
33	NIPPLE	2N01-058RS	1
34	REGULATOR	2408008RRS	1
35	PRESSURE GAUGE	2D12-15D14BAR	2
36	QUICK COUPLER (FOR PC1010EU ONLY)	07S1/4M-ERS	1
37	QUICK COUPLER (FOR PC1010EU COMBO KIT, PC1010S, 6PR2001N)	07OS1/4M-C	1
38	UNLOADING VALVE	2409015	1
39	POWER CABLE (3 PIN)	2E01-044S	1



# Elektrisk Luftkompressor

## Brugsanvisning

(Oversættelse Af De  
Originale Instruktioner)



# SENCO®

Senco Brands, Inc.  
4270 Ivy Pointe Blvd.  
Cincinnati, OH 45245  
1-800-543-4596  
[www.senco.com](http://www.senco.com)  
EMEA: [www.senco-emea.com](http://www.senco-emea.com)



I denne vejledning findes advarsler for sikker brug af denne kompressor.



Læs og forsø alle instruktioner.

## Indholdsfortegnelse

Indledning.....	3
Inspektion.....	3
Sikkerhedsadvarsler.....	4
Kompressorfunktioner.....	8
Forberedelse.....	10
Indledende Installation.....	10
Placering.....	10
Elektrisk.....	10
Drift.....	11
Kontrolliste Før Start.....	11
Opstart.....	11
Afbrydelse.....	11
Vedligeholdelse.....	11
Fejlafhjælpning.....	12
Specifikationer.....	14
Overensstemmelses Deklarationen.....	14
Begrænset Garanti.....	15
Parts Reference Guide.....	16

## Indledning

Tillykke med anskaffelsen af din nye SENCO® Luftkompressor! Du kan være sikker på, at din SENCO Luftkompressor er konstrueret med den største præcision og nøjagtighed. Hver komponent er testet meget nøje af teknikere for at sikre kvaliteten, holdbarheden og ydelsen af denne luftkompressor.

Betjeningsvejledningen er udarbejdet til din fordel. Ved at læse og følge de simple sikkerheds-, installations- og betjenings- samt vedligeholdelsestrin, der er beskrevet i denne vejledning, vil du få mange års problemfri drift med din nye SENCO Luftkompressor. Indholdet i denne vejledning er baseret på den nyeste produktinformation, der var tilgængelig på udgivelsestidspunktet. Producenten forbeholder sig retten til enhver tid, at foretage ændringer i pris, farve, materialer, udstyr, specifikationer eller modeller uden forudgående varsel.



### Sikkerhedsvarsel!

En "FARE, ADVARSEL eller FORSIGTIG" sikkerhedsadvarsel vil stå i en "SIKKERHEDSVARSELKASSE." Denne kasse bruges til at angive og understrege sikkerhedsadvarsler, der skal følges når man betjener denne luftkompressor. Disse sikkerhedsadvarsler ledsages af "Signalord", der angiver graden eller niveauet af farens alvor. "Signalordene" bruges i denne vejledning som følger:

**Fare:** Angiver en overhængende og farlig situation som, hvis den ikke undgås, VIL resultere i død eller alvorlig personskade.

**Advarsel:** Angiver en potentiel og farlig situation som, hvis den ikke undgås, KUNNE resultere i død eller alvorlig personskade.

**Forsigtig:** Angiver en potentiel og farlig situation som, hvis den ikke undgås, KAN resultere i mindre eller moderat personskade eller skade på luft kompressor.



Symbolerne i venstre side i dette afsnit er "Sikkerhedsvarselsymboler". Disse symboler bruges til at rette opmærksomheden på emner eller procedurer, der kan være farlige for dig eller andre personer, der bruger dette udstyr.

**SØRG ALTID FOR, AT DER UDLEVERES EN KOPI AF DENNE VEJLEDNING TIL ENHVER, DER ANVENDER DETTE UDSTYR. LÆS ALLE INSTRUKTIONERNE I DENNE VEJLEDNING OG ALLE INSTRUKTIONER, DER ER LEVERET AF PRODUCENTERNE AF UNDERSTØTTENDE UDSTYR FØR DU TAGER DENNE LUFTKOMPRESSOR I BRUG, OG GØR ISÆR MEGET UD AF "SIKKERHEDSADVARSLERNE" FOR AT UNDGÅ RISIKO FOR PERSONSKADE FOR OPERATØREN.**

## Inspektion

Åbn luftkompressoren og skriv serienummeret på linien herunder. Kontroller for tegn på tydelig eller skjult transportskade. Sørg for, at alle beskadigede dele er udskiftet og at alle mekaniske problemer er rettede forud for ibrugtagning af luftkompressoren.

**SERIENUMMER** \_\_\_\_\_

Hvis du har spørgsmål eller kommentarer, kan du ringe til SENCO's gratis action-linie: **1-800-543-4596** eller send en e-mail til: [toolprof@Senco.com](mailto:toolprof@Senco.com)

Sørg venligst for, at have følgende oplysninger klar ved alle ser viceopkald:



1. Modelnummer
2. Serienummer
3. Dato og købested

Senco, 4270 Ivy Pointe Blvd., Cincinnati, OH 45245

## Sikkerhedsadvarsler





Læs Alle Sikkerhedsadvarsler Før Du Tager Luftkompressoren I Brug

<p><b>Risiko For Elektrisk Stød Eller Død Som Følge Af Elektrisk Stød</b></p>  	<ul style="list-style-type: none"> <li>Ivrigt personskade eller død kan opstå, hvis luftkompressoren ikke er ordentligt jordforbundet. Din luftkompressor er elektrisk drevet og kan forårsage elektrisk stød eller død som følge af elektrisk stød, hvis ikke den bruges ordentligt.</li> </ul>	<ul style="list-style-type: none"> <li>Sørg for, at luftkompressoren er sat i et ordentligt jordforbundet stik med den rigtige spænding og tilstrækkelig sikringsbeskyttelse. g</li> </ul>
	<ul style="list-style-type: none"> <li>Elektrisk stød kan forekomme fra den elektriske ledning.</li> </ul>	<ul style="list-style-type: none"> <li>Kontroller ledningen for tegn på klemninger, revner eller varmeskader. Udskift beskadigede ledninger før brug.</li> <li>Hold alle forbindelser tørre og frie af gulvet. Lad ikke elektriske ledninger ligge i vand eller i en position, hvor de kan komme i kontakt med vand. Berør ikke stikket med våde hænder.</li> <li>Træk ikke i den elektriske ledning for at tage den ud af kontakten.</li> </ul>
	<ul style="list-style-type: none"> <li>Elektrisk stød kan opstå, hvis luftkompressoren ikke betjenes ordentligt.</li> </ul>	<ul style="list-style-type: none"> <li>Brug aldrig luftkompressoren i våde omgivelser eller uden døre, når det regner.</li> <li>Brug aldrig luftkompressoren, hvis sikkerhedsværn/skærme er fjernet eller beskadiget.</li> </ul>
	<ul style="list-style-type: none"> <li>Alvorlig personskade eller død kan opstå, hvis elektriske reparationer udføres af ukvalificerede personer.</li> </ul>	<ul style="list-style-type: none"> <li>Alle elektriske ledningsføringer eller reparationer, der foretages på denne luftkompressor skal foretages af autoriseret servicepersonale i henhold til de nationale og lokale el-koder.</li> <li>Før du åbner nogle af el-skabene, skal du altid afbryde luftkompressoren, lette trykket og tage stikket til luftkompressoren ud kontakten. Lad luftkompressoren køle af. Antag aldrig, at luftkompressoren er sikker at arbejde med bare fordi, den ikke er i drift. Den kan til enhver tid sættes i gang igen!</li> </ul>

## Sikkerhedsadvarsler



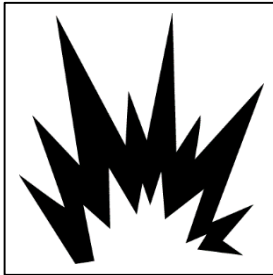

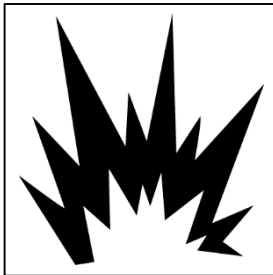

Læs Alle Sikkerhedsadvarsler Før Du Tager Luftkompressoren I Brug

<p><b>Risiko For Eksplosion Eller Brand</b></p>  	<ul style="list-style-type: none"> <li>• Alvorlig personskade eller død kan opstå af normale elektriske gnister i motoren og trykafbryderen.</li> </ul>	<ul style="list-style-type: none"> <li>• Brug altid luftkompressoren i et ordentligt ventileret område, der er fri for brændbare dampe, let antændeligt støv, gasser eller andre let antændelige materialer.</li> <li>• Hvis der sprøjtes med brændbart materiale, skal luftkompressoren placeres mindst 6 meter fra sprøjtningsområdet. (Det kan være nødvendigt med en ekstra slange).</li> </ul>
	<ul style="list-style-type: none"> <li>• Der kan opstå alvorlig personskade, hvis luftkompressorens ventilationsåbninger er blokerede, hvilket kan medføre at luftkompressoren bliver overophedet og dermed starter en brand.</li> </ul>	<ul style="list-style-type: none"> <li>• Anbring aldrig genstande imod eller ovenpå af luftkompressoren. Betjen luftkompressoren mindst 30cm fra en væg eller forhindring, der kan hindre ordentlig ventilation.</li> </ul>
<p><b>Risiko For Sprængning</b></p> 	<ul style="list-style-type: none"> <li>• Alvorlig personskade eller død kan opstå af en eksplosion i luftbeholderen, hvis luftbeholderne ikke vedligeholdes ordentligt.</li> </ul>	<ul style="list-style-type: none"> <li>• Tøm luftbeholderen dagligt eller efter hver brug for at undgå, at der samles fugt i luftbeholderen.</li> <li>• Hvis luftbeholderen udvikler lækage, udskiftes luftbeholderen med det samme. Foretag aldrig reparationer, svejsninger eller ændringer på luftbeholderen eller dens udstyr.</li> <li>• Foretag aldrig justeringer på de fabriksindstillede tryk.</li> </ul>
	<ul style="list-style-type: none"> <li>• Der kan opstå alvorlig personskade fra en fejlfunktion i luftkompressoren eller eksploderende tilbehør, hvis der er anvendt ukorrekte systemkomponenter, udstyr eller tilbehør.</li> </ul>	<ul style="list-style-type: none"> <li>• Overskrid aldrig producentens maksimalt tilladte trykgrænse på udstyret.</li> <li>• På grund af ekstrem varme, må der ikke anvendes plastkrør eller bly-tin loddeforbindelser til en afløbsledning.</li> <li>• Brug aldrig luftkompressoren til at puste små, lavtryksgenstande, som legetøjsgenstande, op med.</li> <li>• Der må kun anvendes originale reparationsdele fra SENCO til luftkompressoren.</li> </ul>

## Sikkerhedsadvarsler





Læs Alle Sikkerhedsadvarsler Før Du Tager Luftkompressoren I Brug

<p><b>Risiko For Indånding</b></p> 	<ul style="list-style-type: none"> <li>• Der kan opstå alvorlig personskade eller død kan opstå, hvis man inhalerer komprimeret luft. Luft strømmen kan indeholde kulilte, giftige dampe eller faste partikler.</li> <li>• Sprøjtede materialer, som maling, opløsningsmidler til maling, farvefjerner, insekticider, ukrudtsmidler osv. indeholder skadelige dampe og giftstoffer.</li> </ul>	<ul style="list-style-type: none"> <li>• Inhaler aldrig luft fra luftkompressoren, hverken direkte eller fra en indåndingsanordning forbundet til luft kompressor.</li> <li>• Brug kun luftkompressoren i et ordentligt ventileret område. Følg allsikkerhedsinstruktionerne, der er leveret med de materialer, som du sprøjter. Det kan være nødvendigt at bruge et åndedrætsværn, når du arbejder med visse materialer. e</li> </ul>
<p><b>Risiko For Brandsår</b></p> 	<ul style="list-style-type: none"> <li>• Der kan opstå alvorlig personskade ved berøring af frilagte metaldele. Disse områder kan forblive varme i et stykke tid efter at luftkompressoren er slukket.</li> </ul>	<ul style="list-style-type: none"> <li>• Lad aldrig dele af kroppen eller andre materialer komme i kontakt med frilagte metaldele på luftkompressor motor eller rørsystem.</li> </ul>
<p><b>Risiko For Flyvende Genstande</b></p> 	<ul style="list-style-type: none"> <li>• Der kan opstå skade på blødt væv fra den komprimerede luftstrøm.</li> </ul>	<ul style="list-style-type: none"> <li>• Bær altid OSHA-påbudte "Z87" sikkerhedsbriller til at beskytte øjnene for flyvende materiale.</li> <li>• Peg aldrig med luftstrømmen på kropsdele, andre personer eller dyr.</li> <li>• Efterlad aldrig trykluftkompressoren uden opsyn. Sluk luftkompressoren og let trykket før vedligeholdelsesarbejde, montage aredskeer eller tilbehør.</li> </ul>
<p><b>Bær Altid Øjenværn</b></p> 	<ul style="list-style-type: none"> <li>• Der kan opstå alvorlig personskade fra løst materiale, der ved høj hastighed bliver hvirvlet rundt af den komprimerede luftstrøm.</li> </ul>	<ul style="list-style-type: none"> <li>• Hold altid sikker afstand til personer og dyr, når du betjener luftkompressoren stopper.</li> <li>• Flyt ikke luftkompressoren, når luftbeholderen er under tryk. Forsøg ikke at flytte luft kompressoren ved trække i slangen.</li> </ul>

## Sikkerhedsadvarsler



Læs Alle Sikkerhedsadvarsler Før Du Tager Luftkompressoren I Brug

<p><b>Risiko Fra Bevægende Dele</b></p>  <p><b>Advarsel: Enheden Kan Starte Uden Varsel</b></p> 	<ul style="list-style-type: none"> <li>Risiko for legemsskade fra bevægende dele. Denne luftkompressor kører automatisk, når trykafbryderen er i positionen <b>ON (1)</b>/Auto.</li> <li>Risiko for personskade fra forsømmelig anvendelse.</li> </ul>	<ul style="list-style-type: none"> <li>Sluk altid luftkompressoren, når den ikke er i brug. Tag trykket fra luftslangen og tag stikket ud af kontakten før du foretager vedligeholdelsesarbejde. Alle reparationer på luftkompressoren skal udføres af en autoriseret serviceperson. Antag aldrig, at det esikkert at arbejde på luftkompressoren, bare fordi den ikke er i drift. Den kan til enhver tid sætte gang igen!</li> <li>Betjen ikke maskinen uden beskyttelsesværn/-skærme. Udskift beskadigede værn/skærme før luftkompressoren kompressor.</li> </ul>
<p><b>Risiko Fra Forsømmelighed</b></p> 	<ul style="list-style-type: none"> <li></li> </ul>	<ul style="list-style-type: none"> <li>Lad aldrig børn og unge betjene denne luftkompressor!</li> <li>Vær opmærksom – se hvad du laver. Betjen ikke luftkompressoren, når der trætt eller hvis du er påvirket af alkohol eller medicin.</li> <li>Vær bekendt med, hvordan du stopper luftkompressor. Vær helt igennem bekendt med kontrolfunktionerne.</li> </ul>
<p><b>Risiko For Skade På Luftkompressoren</b></p>	<ul style="list-style-type: none"> <li>Risiko for stort vedligeholdelsesarbejde.</li> </ul>	<ul style="list-style-type: none"> <li>Betjen ikke luftkompressoren uden et luftfilter.</li> <li>Betjen ikke luftkompressoren i korroderende omgivelser.</li> <li>Betjen altid luftkompressoren i en stabil, sikker position, for at undgå aluftkompressoren falder om.</li> <li>Følg alle vedligeholdelsesinstruktionerne, der er angivet i denne vejledning.</li> </ul>

**! GEM DISSE INSTRUKTIONER !**

## Kompressorfunktioner

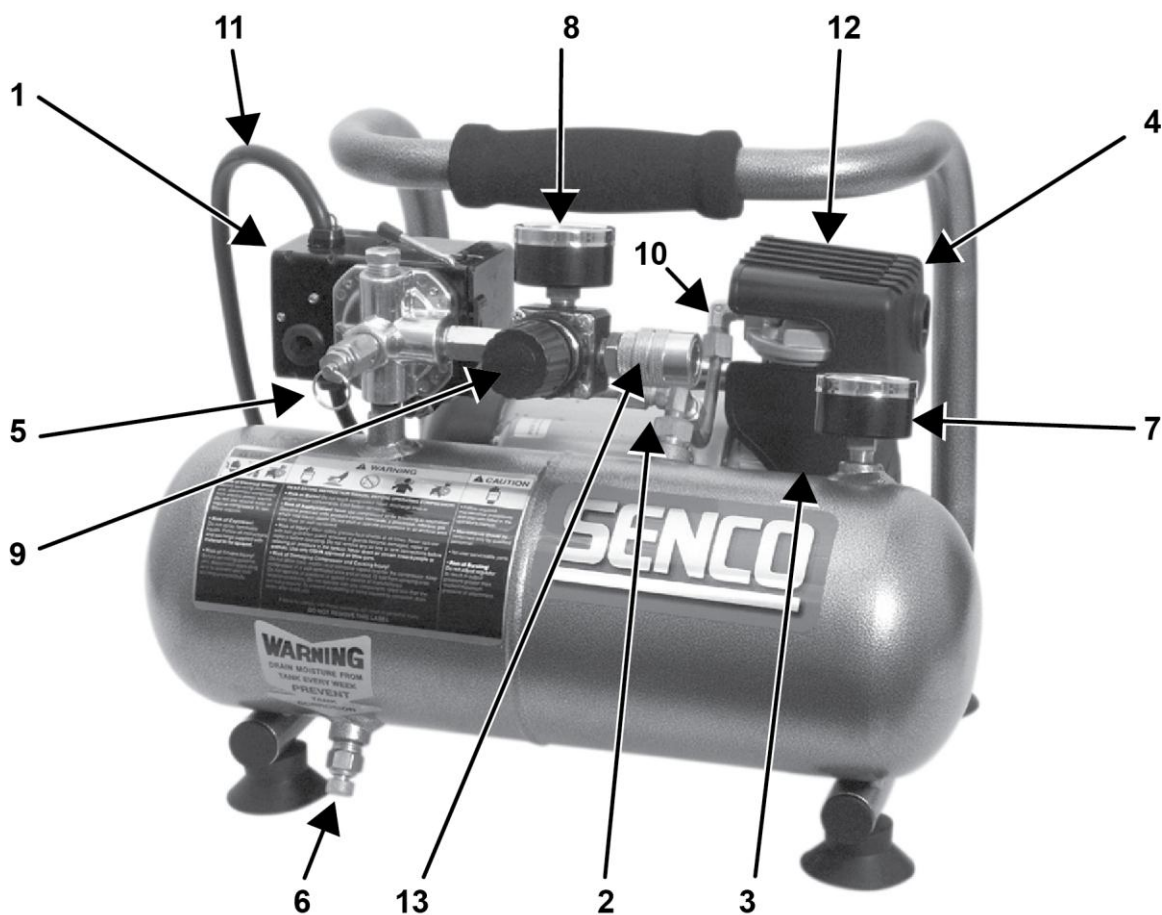

1.	Motor/Trykafbryder
2.	Termisk Overbelastning / Nulstil
3.	Luftindsugningsfilter
4.	Luftkompressorpumpe
5.	Sikkerhedsventil
6.	Luftbeholder Afløbsventil
7.	Beholder Manometer
8.	Aftapningspunkt Manometer
9.	Trykregulator
10.	Afløbsledning
11.	Elektrisk Netledning
12.	Ventilationsåbninger / Beskyttelsesplade
13.	Hurtig Afbrydelse



## Kompressorfunktioner

**1) Motor/Trykafbryder:** Denne afbryder bruges til at starte og stoppe luftkompressoren. Hvis afbryderen flyttes over på positionen **ON (1)**, vil trykafbryderen automatisk få strøm, hvilket tillader motoren at starte, når trykket i luftbeholderen er under det fabriksindstillede tilkoblingstryk. Når den står på **ON (1)**, stopper trykafbryderen motoren, når trykket i luftbeholderen når det fabriksindstillede udkoblingstryk. Af sikkerhedsårsager, har denne afbryder også en overtryksventil på siden, der er udviklet til automatisk at frigive komprimeret luft fra luftkompressorens pumpehoved og afløbsledningen, når luftkompressoren når udkoblingstrykket eller er afbrudt. Det tillader motoren at genstarte frit. Hvis afbryderen flyttes til positionen **OFF (0)**, fjernes strømmen fra trykafbryderen og luftkompressoren stopper.

**2) Motoroverbelastning:** Motoren har et beskyttelseslag, som er placeret på pumpen. Hvis amperetrækket er for stort, udløses bremsen for at beskytte motoren og drivaggregatet. Nulstil bremsen ved at skubbe den sorte plastiktap tilbage i huset. Nulstil kontakten, hvis den udløses.

**3) Luftindsugningsfilter:** Dette filter er udviklet til at rense den luft, der kommer ind i pumpen. For at sikre, at pumpen hele tiden modtager ren, kølig og tør luftforsyning, skal dette filter altid være rent og ventilationsåbningerne skal være fri for blokeringer. Filteret kan fjernes og renses med varmt sæbevand. Skyl filteret grundigt og lad det lufttørre.

**4) Luftkompressorpumpe:** For at komprimere luft, bevæger stemplet sig op og ned i cylindren. Ved den nedadgående bevægelse trækkes luften ind igennem luftindsugningsventilen mens udblæsningsventilen forbliver lukket. Ved den opadgående bevægelse komprimeres luften, indsugningsventilen lukkes og komprimeret luft tvinges ud igennem udblæsningsventilen og ind i afløbsledningen, igennem afspærringsventilen og ind i luftbeholderen.

**5) Sikkerhedsventil:** Denne ventil er udviklet til at forebygge systemfejl ved at lette trykket fra systemet, når den komprimerede luft når et forudbestemt niveau. Ventilen er forudindstillet af producenten og må på ingen måde ændres. Træk i ringen for at kontrollere, at ventilen fungerer ordentligt. Lufttrykket skal slippe ud. Når du har sluppet ringen, vil den blive slibet.

**6) Luftbeholder Afløbsventil:** Afløbsventilen bruges til, at fjerne fugt fra luftbeholderen(-erne) efter at luftkompressoren er afbrudt. **Forsøg ALDRIG at åbne afløbsventilen når, der er mere end 0.7 bar lufttryk i luftbeholderen!** For at åbne afløbsventilen, drejes knappen imod uret. Vip beholderen for at sikre, at alt kondensvandet er løbet ud igennem ventilen.

**7) Luftbeholder Manometer:** Luftbeholderens manometer angiver reservelufttrykket i luftbeholderen(-erne).

**8) Aftapningspunkt Manometer:** Aftapningspunktets manometer angiver det lufttryk, der er tilstede på regulatorens aftapningsside. Trykket er kontrolleret af regulatoren og er altid mindre end eller lig med trykket i luftbeholderen.

**9) Trykregulator:** Det lufttryk, der kommer fra luftbeholderen er kontrolleret af regulatorknappen. Drej trykregulatorknappen med uret for at øge afløbstrykket og imod uret for at mindske afløbstrykket. Følg betjeningsforskrifterne for værktøjet for at opnå det anbefalede tryk område.

**10) Afløbsledning:** Vær opmærksom på, at afløbsledningen er meget varm.

**Varme overflader - Beskyttelsesafskærmningen må ikke fjernes. Høj temperatur efter vedvarende brug.**

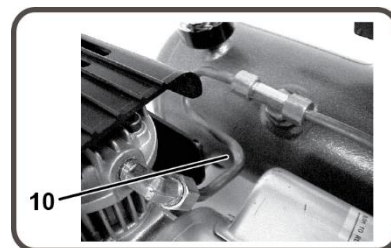
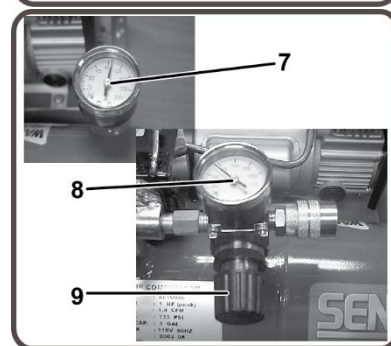
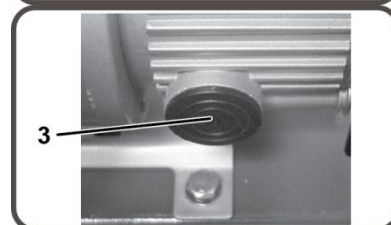
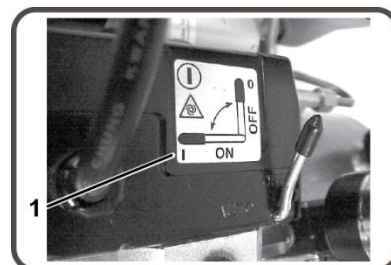

## Forberedelse

### Indledende Installation

1. Læs sikkerhedsadvarselne før du installerer luftkompressoren.

### Placering

#### **Forsigtig**

For at undgå at beskadige luftkompressoren, må luftkompressoren ikke hældes mere end 10 på tværs eller på langs.

1. Anbring luftkompressoren mindst 30cm fra hindringer, der kan hindre ordentlig ventilation.

Anbring ikke luftkompressoren i et område:

- Hvor der er tegn på olie eller gaslækager.
- Hvor der kan være brandfarlige gasdampe eller materialer.

#### **Advarsel**



Alvorlig personskade eller død kan opstå, hvis elektriske gnister fra motoren og trykafbryderen kommer i kontakt med brandfarlige dampe, let antændeligt støv eller andre let antændelige materialer. Når du bruger luftkompressoren til sprøjtemaling, skal luftkompressoren anbringes så langt væk fra arbejdsområdet som muligt, og der skal bruges ekstra luftslanger i stedet for forlængerledninger.

- Hvor lufttemperaturen falder ned under 0C eller overskrider 40C.
- Hvor ekstremt snavset luft eller vand kan komme ind i luftkompressoren.

### Elektrisk

#### **Fare**



Forkert forbindelse af udstyrets jordledning kan medføre risiko for elektrisk stød eller død som følge af elektrisk stød. Kontroller med en kvalificeret elektriker eller servicepersonale, hvis du er i tvivl om stikkontakten er ordentligt jordforbundet. Brug ikke nogen form for adapter med dette produkt. Hvis reparation eller udskiftning af ledningen eller stikket er nødvendigt, skal jordledningen ikke forbindes til nogle af terminalerne med flade stikben. Den ledning, der har en isolering med en udvendig, grøn overflade og med eller uden gule striber, er jordledningen.

#### **Advarsel**



Dette produkt skal være jordforbundet. Hvis der skulle være en fejlfunktion eller en driftsforstyrrelse, giver jordforbindelsen en vej med mindst modstand for elektrisk strøm, hvormed risikoen for elektrisk stød reduceres. Dette produkt er udstyret med en ledning med en beskyttelsesjordingsledning og et jordet stik. Stikket skal være sat ind i en passende stikkontakt, der er installeret korrekt og jordforbundet i henhold til alle lokale regler og normer.

1. SENCO® ANBEFALER IKKE BRUG AF FORLÆNGERLEDNINGER, da det kan medføre effekttab og overophedning af motoren. I stedet anbefales brug af en ekstra luftslange frem for en forlængerledning. Hvis det er uundgåeligt, at anvende en forlængerledning, skal den sættes ind i et HFI-relæ i ledningssskabe eller beskyttede stikkontakter.

Når du anvender en forlængerledning, skal du være opmærksom på følgende:

<u>Kabellængdens</u>	<u>Ledningsmåler</u>
Op til 7,5m	12 AWG
Op til 30m	10 AWG
Op til 50m	8 AWG
Op til 75m	6 AWG

Brug kun forlængerledninger med en mærkekapacitet, der ikke er under produktets kapacitet. Brug ikke beskadigede forlængerledninger. Kontroller forlængerledningen før brug og skift den ud, hvis den er beskadiget.

## Drift

### Kontrolliste Før Start

1. Fjern fugt i luftkompressorens luftbeholder. Fjern overskydende tryk med et luftinstrument. Åbn derefter luftbeholderens afløbsventil i bunden af luftbeholderen. Fjern overtryk ved at trække i overtryksventileringen eller med et trykluftsværktøj og åbn derefter aftapningsventilen til lufttanken, som er placeret nede i lufttanken. Luk den godt til efter tømning.



**Advarsel: Risiko for legemsskade. Forsøg ALDRIG at åbne afløbsventilen, når der er mere end 0.7 bar lufttryk i luftbeholderen!**

2. Sørg for, at luftkompressorens motorkontakt er i positionen **OFF (0)**.
3. Sørg for, at alle sikkerhedsventiler fungerer korrekt.
4. Sørg for, at alle værn og skærme er på plads og er monteret sikkert.

### Opstart

1. Vær sikker på, at håndtaget på trykafbryderskabet er i positionen **OFF (0)**.
2. Sæt strømledningen ind i en jordforbundet kontakt.
3. Flyt håndtaget på trykafbryderskabet til positionen **On (1)**.
4. Det giver luftkompressoren mulighed for, at **Starte** med at opbygge et tryk i luftbeholderne og **Stoppe**, når det korrekte tryk er nået. Når trykket falder ved brugen, vil luftkompressoren **Starte** med på ny at opbygge et tryk.
5. Indstil trykket ved at justere trykregulatorknappen imod uret for reduceret tryk og med uret for øget tryk.
6. Hvis du bemærker en usædvanlig støj eller vibration, stoppes luftkompressoren og du bedes se afsnittet "Fejlafhjælpning."

### Afbrydelse

1. For at stoppe luftkompressoren, skal håndtaget på trykafbryderskabet flyttes til positionen **OFF (0)**. Stop ALDRIG luftkompressoren ved at tage stikket ud af strømkilden. Det kan medføre risiko for død som følge af elektrisk stød.
2. Tøm luftbeholderen for luft ved at frigive luft med et medfølgende luftinstrument eller ved at trække i sikkerhedsventileringen.
3. Når trykket i luftbeholderen registrerer under 0.7 bar, åbnes afløbsventilen under hver luftbeholder for at tømme dem for fugt.
4. Lad luftkompressoren køle ned.
5. Tør luftkompressoren ren og opbevar den på et sikkert, frostfrit sted.

## Vedligeholdelse

Læs brugervejledningen før vedligeholdelsesarbejde. Følgende procedurer skal være udført, når luftkompressoren stoppes for vedligeholdelsesarbejde eller service.

1. Sluk luftkompressoren.



**Advarsel: Antag aldrig, at luftkompressoren er sikker at arbejde på bare fordi den ikke er i drift. Den kan til enhver tid sættes i gang igen!**

2. Tag ledningen ud af hovedstrømforsyningen.
3. Åbn alle afløb.
4. Vent på, at luftkompressoren er kølet af før du påbegynder servicearbejde.

Vedligeholdelsesdiagram			
Procedure	Daglig	Ugentlig	Månedlig
Tøm luftbeholderen(-erne) for kondens	X		
Kontroller for usædvanlig støj/vibration	X		
Kontroller for luftlækager	X		
Kontroller luftfilter		X	
Rengør luftkompressoren udvendigt		X	
Kontroller sikkerhedsventilen			X

## Fejlafhjælpning

<b>Symptom 1. Motoren vil ikke køre eller gen starte.</b>	
<b>Mulig Årsag</b>	<b>Løsning</b>
• Ledningen er ikke sat til.	• Sæt ledningen ind i en jordforbundet stikkontakt.
• Motor/trykafbryder i positionen <b>OFF (0)</b> .	• Flyt afbryderen til positionen <b>ON (1)</b> .
• Motorens termiske overbelastningsafbryder er slået fra.	• Sluk for luftkompressoren, vent til motoren er kølet af og kontroller derefter motorens afbryder.
• Sikring er sprunget eller afbryder er slået fra.	• Skift sikring eller nulstil afbryder. Kontroller for rigtigt sikringsamperetal. Kontroller for lave spændingsforhold. Afbryd alle andre elektriske apparater fra kredsløbet eller betjen luftkompressoren med dens eget forgreningskredsløb.
• Forkert størrelse ledning eller forkert længde på forlængerledning.	• Se diagrammet på side 10 for korrekt størrelse ledning og ledningslængde.
• Luftbeholderens tryk overstiger motorens/trykafbryderens tilkoblingstryk.	• Motoren starter automatisk, når luftbeholderens tryk falder under motorens/trykafbryderens tilkoblingstryk.
• Tag trykket af ledningen ved at flytte afbryderen til positionen <b>OFF (0)</b> .	• Tag trykket af ledningen ved at flytte afbryderen til positionen <b>OFF (0)</b> .
• Defekt motor, motorkondensator, motor/trykafbryder, eller kontroller ventil.	• Kontakt Senco kundeservice.
<b>Symptom 2. Når maskinen er i start/stop, kører motoren konstant.</b>	
<b>Mulig Årsag</b>	<b>Løsning</b>
• Motor/trykafbryder slukker ikke for motoren, når luftkompressoren når udkoblingstrykket og sikkerhedsventilen aktiveres.	• Flyt motoren/trykafbryderen til positionen <b>OFF (0)</b> . Hvis motoren ikke slukkes, tages luftkompressoren ud af stikket. Hvis el-kontakterne er svejset sammen, udskiftes trykafbryderen.
• Luftkompressoren er forkert dimensioneret.	• Begræns lufttrykket til luftkompressorens kapacitet. Anvend enten et mindre instrument eller en større luftkompressor.
<b>Symptom 3. Luften fortsætter med at lække ved motor/trykafbryderens overtryksventil efter at motoren er stoppet.</b>	
<b>Mulig Årsag</b>	<b>Løsning</b>
• Kontrolventilen er åben og sidder fast.	• Fjern, rengør eller udskift.
<b>Symptom 4. Luften fortsætter med at lække ved motor/trykafbryderens overtryksventil mens motoren kører.</b>	
<b>Mulig Årsag</b>	<b>Løsning</b>
• Defekt motor/trykafbryder.	• Udskift
<b>Symptom 5. Der siver luft fra sikkerhedsventilen.</b>	
<b>Mulig Årsag</b>	<b>Løsning</b>
• Mulig defekt sikkerhedsventil.	• Betjen sikkerhedsventilen manuelt ved at trække i ringen. Hvis den stadig lækker, skal den udskiftes.
• Overtryk i luftbeholderen.	• Defekt motor/trykafbryder. Udskift.

## **Fejlafhjælpning**

### **Symptom 6. Der siver luft fra armaturerne.**

<b>Mulig Årsag</b>	<b>Løsning</b>
<ul style="list-style-type: none"><li>• Armaturer er ikke faste nok.</li></ul>	<ul style="list-style-type: none"><li>• Spænd armaturerne, der hvor du kan høre luften siver ud. Kontroller armaturerne med en sæbevandsopløsning. Må ikke overspændes.</li></ul>

### **Symptom 7. Der siver luft fra luftbeholderen.**

<b>Mulig Årsag</b>	<b>Løsning</b>
<ul style="list-style-type: none"><li>• Defekt eller rusten luftbeholder.</li></ul>	<ul style="list-style-type: none"><li>• Luftbeholderen skal udskiftes. Forsøg ikke at reparere luftbeholderen! Der må ikke svejses, repareres eller modificeres.</li></ul>

### **Symptom 8. Der blæser luft fra indsugningsfilteret.**

<b>Mulig Årsag</b>	<b>Løsning</b>
<ul style="list-style-type: none"><li>• Beskadiget indsugnings (blad)ventil.</li></ul>	<ul style="list-style-type: none"><li>• Kontakt SENCO kundeservice.</li></ul>

### **Symptom 9. Utilstrækkeligt tryk ved luftinstrumentet eller tilbehøret.**

<b>Mulig Årsag</b>	<b>Løsning</b>
<ul style="list-style-type: none"><li>• Trykregulatorknappen er ikke drejet til et tilstrækkeligt højt eller der er tale om en defekt trykregulator.</li></ul>	<ul style="list-style-type: none"><li>• Juster trykregulatorknappen til den rigtige indstilling eller udskift den.</li></ul>
<ul style="list-style-type: none"><li>• Blokeret luftindsugningsfilter.</li></ul>	<ul style="list-style-type: none"><li>• Rengør.</li></ul>
<ul style="list-style-type: none"><li>• Luftlækager.</li></ul>	<ul style="list-style-type: none"><li>• Kontroller for lækager og reparer.</li></ul>
<ul style="list-style-type: none"><li>• Luftkompressoren er ikke stor nok til luftkravet.</li></ul>	<ul style="list-style-type: none"><li>• Kontroller det ekstra luftinstrument. Hvis det er højere end CFM eller luftkompressorens trykforsyning, har du brug for en større luftkompressor.</li></ul>

### **Symptom 10. Luftkompressoren producerer ikke luft nok.**

<b>Mulig Årsag</b>	<b>Løsning</b>
<ul style="list-style-type: none"><li>• Blokeret luftindsugningsfilter.</li></ul>	<ul style="list-style-type: none"><li>• Rengør.</li></ul>
<ul style="list-style-type: none"><li>• Defekt indsugnings (blad)ventil.</li></ul>	<ul style="list-style-type: none"><li>• Tøm luftbeholderen og mål oppumpningstiden. Sammenlign med specifikationerne. Hvis de er lavere, fjernes pumpehovedet og ventilpladen. Rengør eller udskift.</li></ul>

### **Symptom 11. Fugt i udløbsluften.**

<b>Mulig Årsag</b>	<b>Løsning</b>
<ul style="list-style-type: none"><li>• Kondens i luftbeholderen forårsaget af et højt niveau af atmosfærisk fugtighed eller luftkompressoren har ikke kørt længe nok.</li></ul>	<ul style="list-style-type: none"><li>• Tøm luftbeholderen efter hver brug. Tøm luftbeholderen oftere i fugtigt vejr og brug et luftledningsfilter</li></ul>

Specifikationer		
Model nr. PC 1010		
<b>Motor</b>	Hestkræfter	0.5 HK (spidsbelastning) / 0.3 KW
	Spænding	230V
	Amperetal	2A
	Hertz	50 Hz
	Fase	Enkelt
	Omdrejn. pr. minut	2850
<b>Kompressorpumpe</b>	Antal cylindere	1
	Kompressionstrin	1
	Krumtaphus	Aluminium
	Lejer	Kugle
	Cylinder	Aluminium
	Ventiler	Blad-enkel
	Hoved	Aluminium
	Filter	Indsætning
<b>Motor/Trykafbryderindstilling</b>	Udkobling	8.6 bar (125 PSI)
	Tilkobling	6.6 bar (95 PSI)
	Kontrolfunktioner	ON (1) / OFF (0)
<b>Luftbeholder</b>	Kapacitet	3.8 Liter(1 Gallon)
<b>Ydelse</b>	L/Min Luftforskydning	32 (1.1 CFM)
	L/Min @ 2.8 bar	17 (0.6 CFM @ 40 PSI)
	L/Min @ 6.2 bar	10 (0.35 CFM @ 90 PSI)
	L/Min @ 6.9 bar	9 (0.31 CFM @ 100 PSI)
	Maksimumtryk	8.6 bar (125 PSIG)
	Oppumpningstid: 0-9 bar	160 sekunder
	Retableringstid: 7-9 bar	48 sekunder
<b>Vægt</b>	Netto	9.1 kg
<b>Dimensioner</b>	Basis LxBxH	36 x 33 x 25 cm
<b>Noise</b>	Measured sound power level (dB)	78 dBA
	Guaranteed sound power level (dB)	81 dBA

## Overensstemmelses Deklarationen

Vi, Senco Brands, Inc.  
 med adress 4270 Ivy Pointe Blvd., Cincinnati, Ohio 45245  
 förklarar i enlighet med följande direktiv:  
**Machindirektiv 2006/42/EG**  
**Pressure Vessel Directive 2009/105/EC.**  
**EMC Directive 2004/108/EC**  
**Low Voltage Directive 2006/95/EC**  
**RoHS Directive 2011/65/EU**  
**Noise Emission Directive 2005/88/EC**  
 och under vårt eget ansvar att: Modell(er):  
**PC 10 10 EU, PC 10 10 EU-2P, PC 10 10 EUS, PC 10 10 EUS-UK110,**  
**PC 10 10 PL, PC 10 10 S, PC 10 10 UK1, PC 10 10 UK2**  
 uppfyller gällande hälso- och säkerhetsföreskrifter angivna i följande  
 document:  
**EN ISO 14121-1:2007, EN ISO 3744:1995, EN ISO 4871:2009,**  
**EN1012-1:2010, EN 60204-1:2006+A1:2009, EN286-1:1998**  
 Undertecknat av: Chris Klein  
 Position: Director of Engineering  
 Plats för konformitetsbeträffelsen: Senco Brands, Inc.  
 4270 Ivy Pointe Blvd., Cincinnati, Ohio 45245  
 Originalt utställt: 4 September 2014  
 Auktoriserad representant:  
 (auktoriserad att sammanställa det tekniska registret)  
 Namn: Peter van der Wel  
 Adress: Senco Brands B.V.  
 Geurdeland 17E, 6673 DR Andelst, The Netherlands

**1. Senco Professional End User Warranty Policy**

Considering the following constraints Senco underwrites the reliability and the quality of its supplied authorised Senco branded products.

1.1 Senco warrants to the end user that the following products will be free from defects in construction, assembly and material for the warranty period specified below.

Product	Warranty period
Senco ® XP Series-Red Cap, pneumatic tools	Five years
Senco ® XP Series-Black Cap, pneumatic tools	Two years
Senco Pro Series, pneumatic tools	One year
Senco Semi-Pro Series, pneumatic tools	One year
Senco DuraSpin ® Series, electric and battery tools	One year
Senco Cordless battery tools	Two years
Senco batteries and chargers for tools	One year
Senco gas tools	Two years
Senco Reconditioned Products	One year
Senco other tools	One year
Senco Compressors	One year

1.2 The warranty period starts on the day the end user purchases the product and/or 1 year after the tool has been deleted from the product line, whichever date comes first.

1.3 To claim warranty the end user needs to send the defective products or their parts, including the serial number and the original and dated sales receipt or proof of purchase from the original retailer or dealer, freight prepaid to the original retailer or dealer.

1.4 Senco is not obliged to do any repairs or replacements on any products or their parts on site.

1.5 During the warranty period Senco or its distributors will repair or replace defective products or their parts, exclusively or mainly as a result of an imperfection in construction, assembly or material, at Senco's option and expense, subject to the constraints of this warranty policy.

1.6 The repair or replacement of products or their parts under warranty, does in no case lead to prolongation of the warranty period. For every replacement product or part, the remaining original warranty period of the replaced product or part is applicable.

1.7 Senco will become the owner of the products or parts that have been replaced by Senco or its distributors as a result of being compliant to Senco's warranty, without being obligated any compensation in this matter.

1.8 Excluded from the warranty are:

- Normal wear and tear parts, for example rubber o-rings, seals, driver blades, piston stops, piston/driver assemblies, isolators, drive belts, air filters and fuel systems, bits;
- Any imperfection that is a result of or has evolved from the fact that there has not been used clean, dry regulated compressed air and/or the air pressure applied has exceeded the maximum indicated on the tool casting (pneumatic tools);
- Any imperfection that is a result of or has evolved from normal wear, misapplication, abuse/misuse, improper modifications or storage, shipping/transport, accidents, neglect, operation at other than recommended speeds or voltage (electric units only);
- Any imperfection that is a result of or has evolved from explosions, fires and natural disasters, like hurricanes, floods and earthquakes;
- Any imperfection that is a result of or has evolved from not following operating instructions, specifications and / or maintenance schedules. Read the Operator Manual for use, specifications and maintenance instructions;
- Any imperfection that is caused by repairs, modifications to the product or attempts to do so by the end user or any third party;
- Labour charges or loss or damage resulting from improper operation, maintenance or repairs are not covered by this warranty
- Any warranty claims that have been received after the warranty period, as specified in this end user warranty, has expired.

1.9 Additional costs like shipping/transport, special packaging requirements and costs of travel and accommodation, are at the end users expense.

1.10 If a complaint is unfounded, all costs incurred thereby, including handling, inspection, shipping and administrative costs on the side of Senco or its distributors, will be charged to the end user.

1.11 After expiration of the warranty period, all costs for repair or replacement, including handling, inspection, shipping and administrative costs will be charged to the end user.

1.12 Notwithstanding legal limitation periods, the limitation of all claims and appeals against Senco and third parties involved by Senco for the implementation of the agreement is one year.

1.13 If Senco fails to meet this agreement, it will not discharge the end user from the obligations arising under this or any other contract.

1.14 When the warranty terms can not be met, due to for example import or export prohibitions, strikes or other unforeseen circumstances, the warranty period will be extended accordingly.

1.15 Senco's liability is limited to the warranty. Senco is not liable for damage caused by the functioning or non-functioning of the products as delivered, repaired or modified by Senco or its distributors, including but not limited to, production losses, profit losses, reduced working range, commercial losses or consequential damages or indirect damages whatsoever.

## Elektrisk Luftkompressor

### Parts Reference Guide

NO:RLB-1409

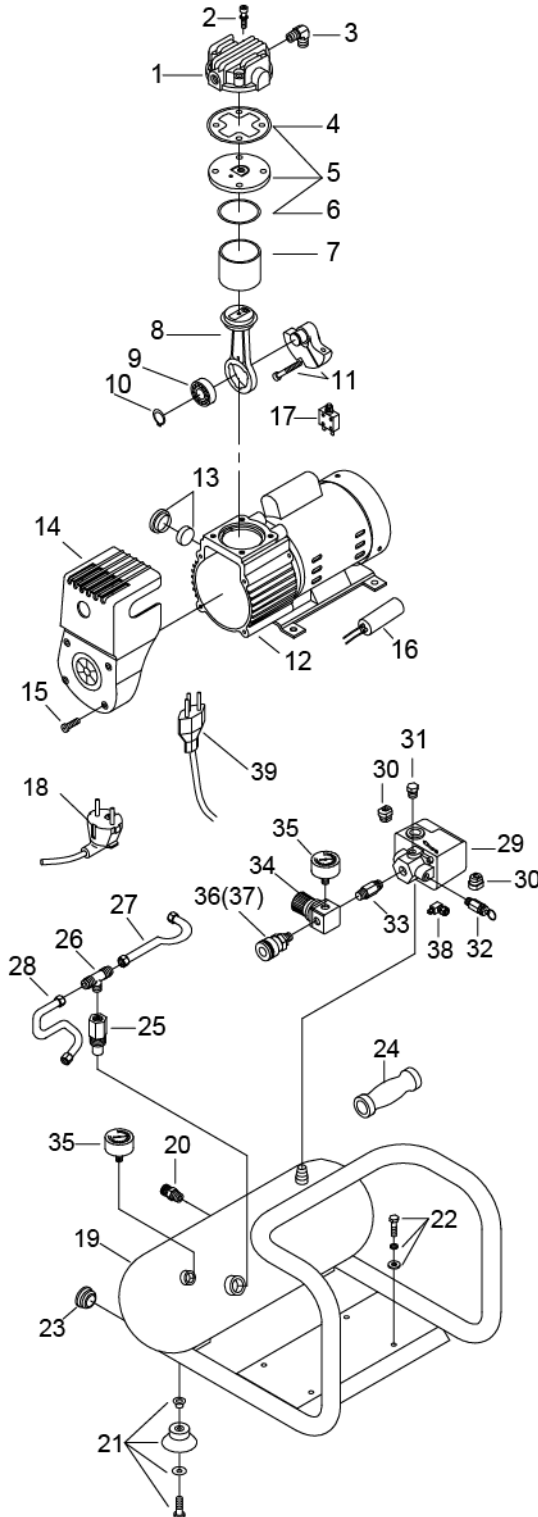

Ref. No.	Description	Part No.	Qty.
1	CYLINDER HEAD	3101063A	1
2	ALLEN BOLT SET	3B01-M05*060V	4
3	EXHAUST ELBOW	2N06-01T02H	1
4	CYLINDER HEAD GASKET	2G01-025H	1
5	EXHAUST VALVE ASSEMBLY	3B11-DC02A	1
6	VALVE SEAT GASKET	2G03-018	1
7	CYLINDER	3201068	1
8	ROD ASSEMBLY	3B3-MB02	1
9	BEARING	2N35-6201ZZC3	1
10	CLIP	2N42-S12	1
11	CRANKSHAFT & BALANCER	3304086	1
12	MOTOR SET	3B8-MB0206S	1
13	AIR FILTER SET	2140026RS	1
14	SHROUD	2428015RS	1
15	BOLT	2B02-FM4*015B	4
16	RUNNING CAPACITOR	2E27-004F4525	1
17	CIRCUIT BREAKER	2E25-01AS	1
18	POWER CABLE (2 PIN)	2E01-029S	1
19	AIR TANK	3401174U	1
20	DRAIN VALVE	2405012	1
21	RUBBER PAD SET	3433011-ARS	4
22	HEXAGON BOLT SET	3B00-FM06*012RS	4
23	PLUG	2N32-W07RS	2
24	GRIP	2432107	1
25	CHECK VALVE	2414033A	1
26	UNLOADING 3-WAY PIPE	2N09-02H01T02H4	1
27	UNLOADING TUBE	3B2-02*190F	1
28	DISCHARGE TUBE	2T02-02*0260RS	1
29	PRESSURE SWITCH	2E21-AA256BPS	1
30	STRAIN RELIEF BUSHING	2E04-008	2
31	PLUG	2N33-009	1
32	PRESSURE RELIEF VALVE	2406021A	1
33	NIPPLE	2N01-058RS	1
34	REGULATOR	2408008RRS	1
35	PRESSURE GAUGE	2D12-15D14BAR	2
36	QUICK COUPLER (FOR PC1010EU ONLY)	07S1/4M-ERS	1
37	QUICK COUPLER (FOR PC1010EU COMBO KIT, PC1010S, 6PR2001N)	07OS1/4M-C	1
38	UNLOADING VALVE	2409015	1
39	POWER CABLE (3 PIN)	2E01-044S	1



# Compresseur d'aire électrique

## Mode D'Emploi

(Traduction Des  
Instructions Originales)



# SENCO<sup>®</sup>

Senco Brands, Inc.  
4270 Ivy Pointe Blvd.  
Cincinnati, OH 45245  
1-800-543-4596  
[www.senco.com](http://www.senco.com)  
EMEA: [www.senco-emea.com](http://www.senco-emea.com)



Des mises en garde pour une utilisation en toute sécurité de ce compresseur sont incluses dans ce manuel.



Maintenez votre zone de travail propre et bien éclairée.

PC1010 • Revisado 11 de Marzo 2015 (Reemplaza 1/24/2013)

## Table Des Matières

Introduction.....	3
Inspection.....	3
Mises En Garde De Sécurité.....	4
Caractéristiques Du Compresseur.....	8
Préparation.....	10
Mise En Œuvre Initiale.....	10
Emplacement.....	10
Alimentation Électrique.....	10
Fonctionnement.....	11
Liste De Vérifications Préliminaires.....	11
Démarrage.....	11
Coupure.....	11
Entretien.....	11
Dépannage.....	12
Spécifications.....	14
Déclaration De Conformité.....	14
Garantie Limitée.....	15
Parts Reference Guide.....	16

## Introduction

Félicitations pour votre achat de notre nouveau compresseur d'air SENCO®! Vous pouvez être assuré que votre compresseur d'air SENCO a été construit avec le plus haut niveau de précision et d'exactitude. Chaque composant a été rigoureusement testé par des techniciens pour constituer la qualité, l'endurance et la performance de ce compresseur d'air.

Ce manuel d'utilisation a été composé pour vous servir. En lisant puis en appliquant les étapes simples décrites dans de manuel de sécurisation, installation et fonctionnement, et entretien, vous aurez des années de service sans souci pour votre nouveau compresseur à air SENCO. Le contenu de ce manuel est basé sur les dernières informations produit disponibles au moment de sa publication. Le constructeur se réserve le droit d'opérer des changements sur prix, couleur, matériel et équipement, spécifications ou modèles, à tout moment et sans préavis.



### Alertes Pour La Sécurité!

Une signalisation pour DANGER, AVERTISSEMENT ou ATTENTION pour la sécurité sera entouré d'un encadrement d'alerte. Ce cadre est utilisé pour montrer et renforcer les mesures de sécurité qui doivent être respectées pour faire fonctionner ce compresseur d'air. En accompagnement des mises en garde de sécurité il y a les mots clés d'alerte qui donnent le degré de danger du risque. Les mots utilisés dans ce manuel sont:

**Danger:** Indique une situation très dangereuse, qui si les mesures ne sont pas prises ENTRAÎNERA une blessure sérieuse voire mortelle.

**Avertissement:** Indique une situation potentiellement dangereuse, qui si les mesures ne sont pas prises ENTRAÎNERAIT une blessure sérieuse voire mortelle.

**Attention:** Indique une situation potentiellement dangereuse, qui si les mesures ne sont pas prises POURRAIT ENTRAÎNER une blessure légère ou endommager le compresseur d'air.

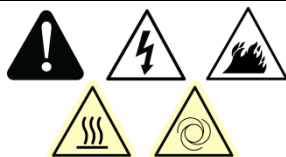

Les symboles placés à la gauche de ce paragraphe sont les symboles d'alerte de sécurité, ils sont utilisés pour attirer l'attention sur des articles ou procédures qui pourraient présenter un danger pour vous ou d'autres personnes utilisant cet équipement.

**FOURNISSEZ TOUJOURS UNE COPIE DE CE MANUEL À TOUTE PERSONNE QUI VA UTILISER CET ÉQUIPEMENT. IL FAUT LIRE TOUTES LES INSTRUCTIONS DE CE MANUEL PLUS TOUTES LES INSTRUCTIONS FOURNIES PAR LES FABRICANTS DES ÉQUIPEMENTS ANNEXES AVANT DE FAIRE FONCTIONNER LE COMPRESSEUR D'AIR, ET PRÊTER UNE ATTENTION TOUTE PARTICULIÈRE AUX MISES EN GARDE DE SÉCURITÉ POUR ÉVITER LA POSSIBILITÉ DE BLESSURES CORPORELLES POUR L'OPÉRATEUR.**

## Inspection

Déballez le compresseur d'air et écrivez son numéro de série dans l'emplacement fourni plus bas. Inspectez pour chercher des signes d'éventuels dommages évidents ou cachés venant du transport. Assurez-vous que toutes pièces endommagées soient remplacées et que tout problème mécanique soit résolu avant de mettre le compresseur d'air en marche.

**NUMÉRO DE SÉRIE** \_\_\_\_\_

Si vous avez des questions ou commentaires à transmettre, contactez SENCO par appel sans frais au: **1-800-543-4596** ou en envoyant un message électronique à: [toolprof@Senco.com](mailto:toolprof@Senco.com)

Veillez avoir sous la main ces informations en cas d'appel pour n'importe quel service:



1. Référence de modèle
2. Numéro de série
3. Date et lieu d'achat

Senco, 4270 Ivy Pointe Blvd., Cincinnati, OH 45245

## Mises En Garde De Sécurité





**Lisez Toutes Les Mises En Garde De Sécurité Avant D'Utiliser  
Le Compresseur D'Air**

Danger	Consequences Potentielles	Prevention
<p style="text-align: center;"><b>Risque De Commotion Électrique Ou D'Électrocution</b></p> <div style="text-align: center;">      </div>	<ul style="list-style-type: none"> <li>Des blessures graves ou mortelles peuvent arriver si le compresseur n'est pas mis à la terre de façon convenable. Votre compresseur d'air est alimenté de l'électricité et cela peut provoquer une commotion électrique ou une électrocution si l'utilisation n'est pas correcte.</li> </ul>	<ul style="list-style-type: none"> <li>Assurez-vous que compresseur d'air est bien branché sur une prise secteur convenablement reliée à la terre, qui fournit la tension correcte, et qui est protégée en amont par fusible ou disjoncteur.</li> </ul>
	<ul style="list-style-type: none"> <li>Une commotion électrique peut venir du cordon secteur.</li> </ul>	<ul style="list-style-type: none"> <li>Vérifiez le cordon secteur pour y déceler des signes d'écrasement, de coupure ou de brûlure. Remplacez le cordon s'il est abîmé avant toute nouvelle utilisation.</li> <li>Gardez toutes les connexions au sec et ne reposant pas par terre. Ne laissez pas le cordon secteur traîner dans l'eau ou dans une position telle que de l'eau puisse venir à son contact. Ne touchez pas la fiche secteur avec des mains mouillées.</li> </ul>
	<ul style="list-style-type: none"> <li>Une commotion électrique peut arriver si le compresseur n'est pas utilisé correctement.</li> </ul>	<ul style="list-style-type: none"> <li>Ne tirez pas sur le cordon secteur pour débrancher la fiche de la prise murale.</li> <li>Ne faites jamais fonctionner le compresseur d'air dans des conditions d'humidité ou à l'extérieur quand il pleut.</li> </ul>
	<ul style="list-style-type: none"> <li>Des blessures graves ou mortelles peuvent arriver si des réparations électriques sont tentées par des personnes non qualifiées.</li> </ul>	<ul style="list-style-type: none"> <li>Ne faites jamais fonctionner le compresseur d'air avec ses couvercles et protections de sécurité enlevés.</li> <li>Tout câblage ou dépannage électrique effectué sur le compresseur d'air doit être confié à un personnel de dépannage agréé, en conformité avec les réglementations électriques locales et nationales.</li> <li>Avant d'ouvrir toute partie électrique fermée, arrêtez toujours le compresseur d'air, faites chuter la pression et débranchez l'appareil de sa prise secteur. Laissez le compresseur d'air refroidir. Ne présumez jamais que vous pouvez intervenir en sécurité sur le compresseur d'air juste parce qu'il ne tourne pas. Il pourrait redémarrer inopinément!</li> </ul>

## Mises En Garde De Sécurité



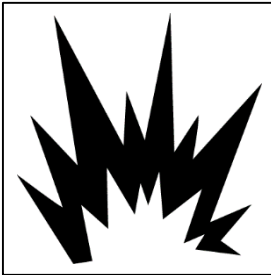

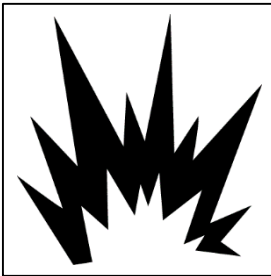

Lisez Toutes Les Mises En Garde De Sécurité Avant D'Utiliser  
Le Compresseur D'Air

Danger	Consequences Potentielles	Prevention
<p><b>Risque D'Explosion Ou D'Incendie</b></p>  	<ul style="list-style-type: none"> <li>Des blessures sérieuses voire mortelles peuvent arriver à partir d'étincelles électriques normales au niveau du moteur ou du manostat.</li> <li>Des blessures sérieuses peuvent arriver si des ouvertures de ventilation du compresseur d'air sont obstruées, provoquant la surchauffe de l'appareil et l'amenant à prendre feu.</li> </ul>	<ul style="list-style-type: none"> <li>Faites toujours fonctionner le compresseur d'air dans une zone bien ventilée exempte de vapeurs inflammables, de poussière combustible, de gaz ou autres matières combustibles.</li> <li>Si vous pulvérisiez sous pression de la matière inflammable, placez le compresseur d'air au moins 6 mètres plus loin que la zone traitée (vous pouvez avoir besoin d'un flexible auxiliaire).</li> <li>Ne placez jamais de objets contre ou sur le compresseur d'air. Faites-le fonctionner à au moins 30 cm à l'écart de tout mur ou obstacle qui pourrait empêcher une ventilation convenable.</li> </ul>
<p><b>Risque D'Éclatement</b></p> 	<ul style="list-style-type: none"> <li>Des blessures sérieuses voire mortelles peuvent arriver suite à une explosion d'un réservoir d'air, suite à un mauvais entretien.</li> <li>Des blessures sérieuses peuvent arriver par un dysfonctionnement du compresseur d'air ou l'explosion d'accessoires, si des composants, annexes ou accessoires du système qui seraient de type incorrect sont utilisés.</li> </ul>	<ul style="list-style-type: none"> <li>Purgez le réservoir d'air quotidiennement, ou après chaque utilisation, afin d'éviter une accumulation d'humidité à l'intérieur.</li> <li>Si une fuite est constatée au réservoir d'air, il faut immédiatement le remplacer. Ne jamais chercher à réparer, souder ou modifier le réservoir d'air ni ses accessoires.</li> <li>Ne jamais modifier les pression réglées en usine.</li> <li>Ne dépassez jamais la pression correspondant au maximum nominal admissible par les accessoires reliés.</li> <li>Du fait de la température très élevée, n'utilisez pas de tuyauterie plastique ou de jonctions soudées à l'étain pour la conduite de sortie.</li> <li>N'utilisez jamais le compresseur pour gonfler des petits objets pour basse pression, comme les jouets.</li> <li>Tous les tuyaux et garnitures conviendront pour l'usage d'emplacement à la pression d'utilisation maximale permise du compresseur portatif.</li> <li>Utilisez uniquement les pièces de rechange originales de Sencor pour votre compresseur d'air.</li> </ul>

## Mises En Garde De Sécurité

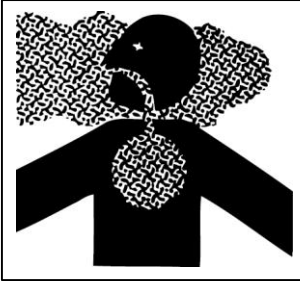



Lisez Toutes Les Mises En Garde De Sécurité Avant D'Utiliser  
Le Compresseur D'Air

Danger	Conséquences Potentielles	Prevention
<p><b>Risque D'Inhalation</b></p> 	<ul style="list-style-type: none"> <li>Des blessures sérieuses voire mortelles peuvent arriver suite à l'inhalation d'air comprimé. Le courant d'air peut contenir du monoxyde de carbone, des vapeurs toxiques ou des particules solides.</li> <li>Des matières vaporisées comme peinture, solvants pour peinture, décapants, insecticides, herbicides, etc. peuvent contenir des vapeurs et poisons qui présentent un danger. Des blessures sérieuses peuvent.</li> </ul>	<ul style="list-style-type: none"> <li>Ne respirez jamais de l'air venant du compresseur d'air, ni directement par un appareil respiratoire branché sur le compresseur d'air.</li> <li>Ne faites fonctionner le compresseur d'air que dans une zone bien ventilée. Respectez toutes les instructions fournies avec le produit que vous vaporisez. L'utilisation d'un masque respiratoire peut être nécessaire pour appliquer certains produits.</li> </ul>
<p><b>Risque De Brûlure</b></p> 	<ul style="list-style-type: none"> <li>Des blessures sérieuses peuvent arriver en touchant des pièces métalliques exposées. Ces surfaces peuvent rester très chaudes pendant un certain temps après l'arrêt du compresseur d'air.</li> </ul>	<ul style="list-style-type: none"> <li>Ne laissez jamais une partie quelconque de votre corps ou des objets entrer en contact avec n'importe quelle partie métallique exposée du compresseur d'air, moteur ou pipework.</li> </ul>
<p><b>Risque D'Objets Projetés</b></p> 	<ul style="list-style-type: none"> <li>Des dommages aux tissus fragiles peuvent être provoqués par le jet d'air comprimé.</li> </ul>	<ul style="list-style-type: none"> <li>Portez toujours des lunettes de sécurité norme OSHA "Z87" pour protéger vos yeux des débris projetés.</li> <li>Ne dirigez jamais le jet d'air comprimé vers une quelconque partie de votre corps, ni vers d'autres personnes ou des animaux.</li> <li>Ne laissez jamais le compresseur d'air en marche sans surveillance. Coupez le compresseur et libérez la pression avant toute intervention sur le compresseur, comme le rattachement d'outils ou accessoires.</li> </ul>
<p><b>Portez Toujours Des Lunettes De Protection</b></p> 	<ul style="list-style-type: none"> <li>Des blessures sérieuses peuvent arriver par le fait que des débris libérés peuvent être projetés à grande vitesse par le jet d'air comprimé.</li> </ul>	<ul style="list-style-type: none"> <li>Gardez toujours une distance de sécurité par rapport aux personnes et aux animaux en faisant fonctionner le compresseur d'air.</li> <li>Ne déplacez pas le compresseur d'air pendant que son réservoir est encore sous pression. Ne tentez pas de déplacer le compresseur en le tirant par sa conduite.</li> </ul>

## Mises En Garde De Sécurité

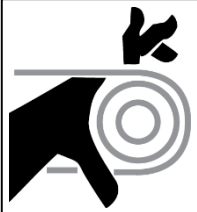

**Lisez Toutes Les Mises En Garde De Sécurité Avant D'Utiliser  
Le Compresseur D'Air**

Danger	Consequences Potentielles	Prevention
<p style="text-align: center;"><b>Risque Présenté Par Les Pièces Mobiles</b></p>  <p style="text-align: center;"><b>Attention! Sans Prévenir E Groupe De Compression Peur Se Mettre En Marche</b></p> 	<ul style="list-style-type: none"> <li>• Risque de blessure corporelle venant des pièces mobiles. Le compresseur d'air se relance automatiquement quand son manostat est sur la position <b>ON (1)</b>/Auto.</li> </ul>	<ul style="list-style-type: none"> <li>• Coupez toujours le compresseur d'air quand vous ne vous servez pas de l'air comprimé. Purgez la pression du flexible d'envoi d'air débranchez l'appareil de sa prise secteur avant d'entamer tout entretien. Toutes les réparations sur le compresseur d'air doivent et L être menées par un agent de dépannage autorisé. Ne présume jamais que vous pouvez intervenen sécurité sur le compresseur d'air juste parce qu'il ne tourne pas. Il pourrait redémarrer inopinément!</li> <li>• Ne pas faire fonctionner sans protection couvertures / gardes. Remplacer endommagés couvertures / gardes avant d'utiliser le compresseur d'air.</li> </ul>
<p style="text-align: center;"><b>Risque Par Négligence</b></p> 	<ul style="list-style-type: none"> <li>• Risque de blessure par utilisation négligente.</li> </ul>	<ul style="list-style-type: none"> <li>• Ne laissez jamais enfants ou adolescents faire fonctionner ce compresseur d'air!</li> <li>• Restez attentif à ce que vous faitNe faites pas fonctionner le compresseur d'air si vous êtes fatigué ou sous l'influence d'alcoou médicaments.</li> <li>• Sachez comment arrêter le compresseur d'air. Familiarisez-vous avec ses commandes.</li> </ul>
<p style="text-align: center;"><b>Risque De Dommages Au Compresseur D'Air</b></p>	<ul style="list-style-type: none"> <li>• Risque d'avoir à procéder à des réparations lourdes.</li> </ul>	<ul style="list-style-type: none"> <li>• Ne faites pas fonctionner le compresseur d'air sans son filtreair.</li> <li>• Ne faites pas fonctionner le compresseur d'air dans un environnement corrosif.</li> <li>• Faites toujours fonctionner le filtà air en position stable et sûre poéviter qu'il ne tombe.</li> <li>• Suivez bien toutes les instructiond'entretien données dans ce manuel.</li> </ul>

**! CONSERVEZ CES INSTRUCTIONS !**

## Caractéristiques Du Compresseur

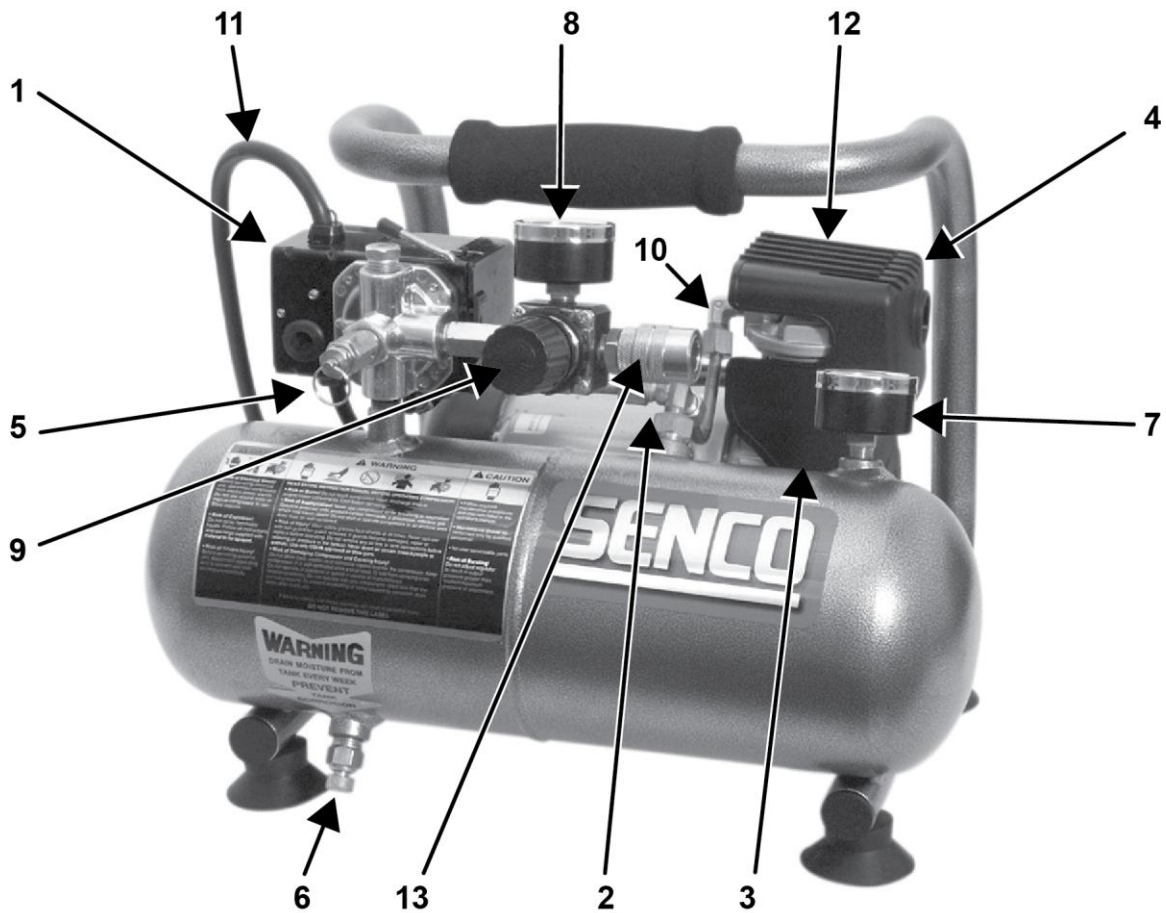

1.	Moteur, manostat
2.	Rupteur thermique / restauration
3.	Filtre d'entrée d'air
4.	Pompe du compresseur d'air
5.	Soupape de sûreté
6.	Robinet de purge du réservoir d'air
7.	Manomètre de pression de réservoir
8.	Manomètre de refoulement
9.	Régulateur de pression
10.	Conduite de refoulement
11.	Cordon secteur
12.	Ouvertures de ventilation / coiffe de protection
13.	Déconnexion rapide



## Caractéristiques Du Compresseur

**1) Moteur / Manostat:** Ce commutateur est utilisé pour démarrer ou arrêter le compresseur d'air. En le passant sur la position **ON (1)**, le manostat est alimenté et de façon automatique commande le démarrage du moteur quand la pression dans le réservoir d'air est en dessous du seuil de pression basse fixé en usine. Quand il est sur la sélection **ON (1)**, le manostat commande la coupure du moteur quand la pression dans le réservoir d'air est au dessus du seuil de pression haute fixé en usine. Pour des raisons de sécurité le manostat comporte également une soupape de surpression située sur le côté, conçue pour relâcher automatiquement l'air comprimé de la tête de pompe du compresseur d'air et de sa conduite de déchargement quand l'appareil atteint sa pression de coupure ou est arrêté. Cela permet au moteur de redémarrer librement. Le passage du manostat en position **OFF (0)** lui coupe son alimentation et arrête le compresseur d'air.

**2) Surcharge Du Moteur:** Le moteur possède un dispositif d'arrêt situé sur la pompe. Un ampérage excessif déclenchera le dispositif d'arrêt pour protéger le moteur et l'utilisateur. Réinitialiser le dispositif d'arrêt en poussant la tige en plastique noir dans le boîtier. Réinitialiser l'interrupteur s'il s'est déclenché.

**3) Filtre D'entrée D'Air:** Ce filtre est prévu pour nettoyer l'air qui arrive à la pompe. Pour assurer une arrivée d'air frais à la pompe continuellement propre et sec, ce filtre doit rester toujours propre et l'ouverture de ventilation libre de toute obstruction. Le filtre peut être déposé pour un nettoyage utilisant de l'eau savonneuse chaude. Rincez ensuite le filtre et faites-le sécher.

**4) Pompe Du Compresseur D'Air:** Pour compresser l'air, le piston monte et descend dans le cylindre. Dans le mouvement de descente, l'air est aspiré par la soupape d'admission, tandis que la soupape d'échappement reste fermée. Dans le mouvement de remontée, l'air est comprimé, la soupape d'admission se ferme et l'air comprimé est chassé par la soupape d'échappement dans la conduite d'échappement, au travers du clapet anti-retour puis dans le réservoir d'air.

**5) Soupape De Sûreté:** Cette soupape est conçue pour éviter des pannes de système en relâchant sa pression quand l'air comprimé atteint un niveau prédéterminé. La soupape est réglée à l'avance par le constructeur et ne doit être retouchée en aucune manière. Pour vérifier le bon fonctionnement de cette soupape, tirer sur l'anneau. De l'air sous pression doit s'échapper. Quand l'anneau est relâché la soupape se remet en place.

**6) Robinet De Purge Du Réservoir D'Air:** Ce robinet de purge est utilisé pour évacuer l'humidité du réservoir d'air après l'arrêt du compresseur. **Ne JAMAIS essayer d'ouvrir ce robinet quand il y a plus de 0,7 bar de pression dans le réservoir d'air!** Pour ouvrir ce robinet de purge, tournez son bouton dans le sens du dévissage. Penchez le réservoir pour vous assurer que toute l'eau coule bien par le robinet.

**7) Manomètre De Réservoir D'Air:** Ce manomètre indique la pression de l'air comprimé en réserve dans le réservoir d'air.

**8) Manomètre De Refoulement:** Ce manomètre indique la pression d'air disponible du côté de sortie du régulateur. Cette pression est contrôlée par le régulateur et elle est toujours inférieure ou égale à celle de l'air du réservoir.

**9) Régulateur De Pression:** L'air sous pression venant du réservoir d'air est contrôlé par le bouton du régulateur. En tournant ce bouton dans le sens du vissage on augmente la pression de sortie, et en sens contraire on la diminue. Respecter les instructions d'utilisation des outils pour la gamme de pression recommandée.

**10) Conduite De Refoulement:** Veuillez garder en mémoire que cette conduite est très chaude. Surfaces chaudes: **Ne pas retirer le carter de protection. Haute température possible après une utilisation soutenue.**

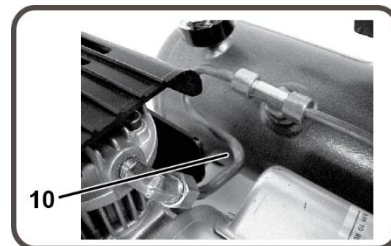
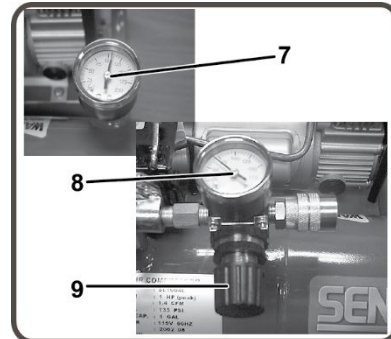
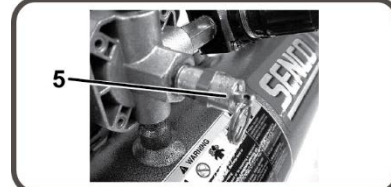
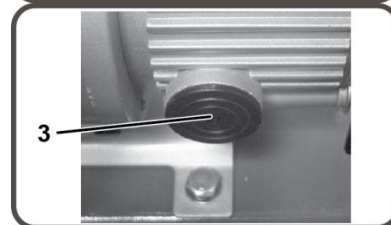
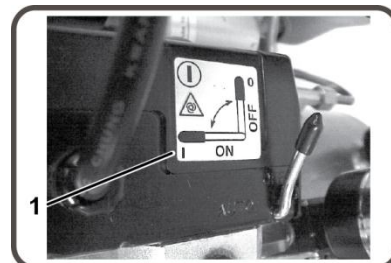

## Préparation

### Mise En Œuvre Initiale

1. Lisez les mises en garde de sécurité avant de mettre en œuvre le compresseur d'air.

### Emplacement

**Attention** De façon à éviter d'endommager le compresseur d'air, ne l'inclinez pas transversalement ou longitudinalement de plus de 10.

1. Placez le compresseur d'air au moins à 30 cm de tous les obstacles qui pourraient empêcher une bonne ventilation. Ne le placez pas dans toute zone où:
  - Il y a une évidence de fuites de gaz ou d'huile.
  - Il y a des vapeurs ou des matériaux inflammables.

### Avertissement



Des blessures graves voire mortelles peuvent survenir si des étincelles électriques du moteur ou du manostat entrent en contact avec de vapeurs inflammables, de la poussière de combustible, des gaz ou d'autres matériaux combustibles. Quand vous utilisez le compresseur d'air pour vaporiser de la peinture, placez-le le plus loin possible de la zone de travail, utilisez une rallonge de flexible plutôt qu'une rallonge de cordon secteur.

- Où la température de l'air tombe en dessous de 0C ou dépasse 40C.
- Où de l'air très pollué ou de l'eau peut entrer dans le compresseur.

### Alimentation Électrique

### Danger



Une connexion incorrecte du conducteur de mise à la terre de l'équipement peut entraîner un risque de commotion électrique ou d'électrocution. Faites vérifier par un électricien qualifié ou un agent de dépannage si vous avez un doute quant à la bonne mise à la terre de la prise secteur. N'utilisez aucun type d'adaptateur avec ce produit. Si la réparation ou le remplacement du cordon secteur s'avère nécessaire, ne connectez pas le fil de terre sur l'une ou l'autre des bornes à lame plate. Le fil avec isolant dont la surface extérieure est verte avec ou sans rayures jaunes est le fil de terre.

### Avertissement



Ce produit doit être mis à la terre. En cas d'hypothétique dysfonctionnement ou panne, la mise à la terre fournit un chemin de moindre résistance pour le courant électrique, ce qui réduit le risque de commotion électrique ou d'électrocution. Ce produit est équipé d'un cordon ayant un fil pour la mise à la terre de l'équipement et une fiche secteur de type mise à la terre. Cette fiche doit être enfoncée dans une prise murale adéquate correctement installée et reliée à la terre en conformité avec toutes les normes et réglementations locales.

1. SENCO ne recommande pas l'utilisation de rallonges secteur, car cela provoque de la perte de puissance et une surchauffe du moteur. Utilisez plutôt une rallonge de flexible de sortie d'air comprimé. Si vous étiez dans l'obligation d'utiliser une rallonge secteur, elle doit être branchée sur boîte de raccordement protégée par disjoncteur différentiel ou sur des prises protégées. Quand vous utilisez une rallonge secteur, observez ces règles:

Longueur de câble	Calibre AWG de fil
Jusqu'à 7,5 m	12 AWG
Jusqu'à 30 m	10 AWG
Jusqu'à 50 m	8 AWG
Jusqu'à 75 m	6 AWG

N'utilisez que des rallonges secteur ayant au moins de spécifications égales à celles du cordon du produit. N'utilisez pas de rallonge électrique usagée. Examinez la rallonge avant de l'utiliser et rejetez-la si elle est endommagée. N'abusez pas des rallonges électriques et ne tirez pas sur le câble pour débrancher. Gardez le cordon à l'écart de la chaleur et des angles vifs. Coupez toujours le compresseur d'air à son interrupteur avant de débrancher sa prise secteur.

## Fonctionnement

### Liste De Vérifications Préliminaires

1. Enlevez toute humidité du réservoir d'air comprimé. Faites retomber la pression en activant un outil mu par air comprimé, puis ouvrez le robinet de purge en bas du réservoir. Éliminer la pression excessive en tirant la valve de décharge de pression de sécurité ou avec un appareil à air, ensuite ouvrir la valve de drainage de la chambre à air située au fond de celle-ci. Refermez-le bien quand l'eau est évacuée.



**Avertissement: Risque de blessure corporelle. N'essayez JAMAIS d'ouvrir le robinet de purge quand il y a une pression d'air de plus de 0,7 bar dans le réservoir!**

2. Assurez-vous que le commutateur du moteur du compresseur est en position d'arrêt **OFF (0)**.
3. Assurez-vous que toutes les soupapes de sécurité fonctionnent bien.
4. Vérifiez que toutes les protections et couvercles sont en place et bien fixés.

### Démarrage

1. Assurez-vous que le levier de la boîte de commutateur de pression est sur position d'arrêt **OFF (0)**.
2. Branchez la fiche secteur dans la prise secteur murale.
3. Déplacez le levier de la boîte de commutateur de pression en position **ON (1)**.
4. Cela va permettre au compresseur d'air de commencer à bâtir une pression dans le réservoir d'air et de s'arrêter quand la pression prédéterminée correcte est atteinte. Quand la pression descend par l'utilisation de l'air comprimé, le compresseur se met tout seul en marche pour la remonter.
5. Réglez la pression d'air de sortie en tournant le bouton du régulateur (sens du dévissage pour la baisser, sens du vissage pour l'augmenter).
6. Si vous remarquez bruit ou vibration anormaux, arrêtez le compresseur d'air et reportez-vous à la section "Dépannage."

### Coupure

1. Pour arrêter le compresseur d'air, déplacez le levier de la boîte de commutateur de pression en position d'arrêt **OFF (0)**. N'arrêtez JAMAIS le compresseur d'air en débranchant sa fiche secteur. Cela peut provoquer un risque d'électrocution.
2. Faites retomber la pression en activant un outil mu par air comprimé, ou en tirant sur l'anneau de la soupape de sûreté.
3. Une fois que la pression dans le réservoir d'air est retombée à moins de 0.7 bar, ouvrez le robinet de purge sous le réservoir pour évacuer toute l'eau résiduelle.
4. Laissez le compresseur refroidir.
5. Essayez proprement le compresseur et entreposez-le dans un endroit sûr et hors gel.

## Entretien

Lisez ce manuel d'instructions avant d'effectuer un quelconque entretien. Les procédures qui suivent doivent être suivies au moment de l'arrêt du compresseur d'air en cas d'entretien ou de dépannage.

1. Coupez le compresseur d'air à son interrupteur.



**xxx: Ne présumez jamais que vous pouvez intervenir en sécurité sur le compresseur d'air juste parce qu'il ne tourne pas. Il pourrait redémarrer inopinément!**

2. Débranchez le cordon secteur de la prise secteur xxx.
3. Ouvrez toutes les vidanges.
4. Laissez refroidir le compresseur d'air avant de démarrer l'intervention.

Tableau D'Entretien			
Procédure	Quotidien	Hebdomadaire	Mensuel
Purger la condensation du réservoir d'air	X		
Chercher des bruits/vibrations anormaux	X		
Chercher des fuites d'air	X		
Inspecter le filtre à air		X	
Nettoyer l'extérieur du compresseur		X	
Vérifier la soupape de sûreté			X

## Dépannage

### Symptôme 1 – Le moteur ne tourne pas ou ne redémarre pas.

Cause Probable	Remède
<ul style="list-style-type: none"> <li>Le cordon secteur n'est pas branché.</li> </ul>	<ul style="list-style-type: none"> <li>Connectez le cordon sur la prise secteur.</li> </ul>
<ul style="list-style-type: none"> <li>Le commutateur moteur/pression est sur arrêt <b>OFF (0)</b>.</li> </ul>	<ul style="list-style-type: none"> <li>Passez le commutateur en position de marche <b>ON (1)</b>.</li> </ul>
<ul style="list-style-type: none"> <li>Le rupteur thermique s'est déclenché.</li> </ul>	<ul style="list-style-type: none"> <li>Coupez le compresseur d'air, attendez que le moteur refroidisse, puis vérifiez le rupteur du moteur.</li> </ul>
<ul style="list-style-type: none"> <li>Calibre de fil insuffisant ou longueur de rallonge trop élevée.</li> </ul>	<ul style="list-style-type: none"> <li>Vérifiez que le fusible a le bon ampérage. Vérifiez si la tension secteur ne descend pas trop bas. Débranchez tous les autres appareillages de ce circuit d'alimentation, ou aménagez un circuit d'alimentation électrique que pour le compresseur. Vérifiez en page 10 la bonne correspondance entre calibre et longueur du cordon secteur.</li> </ul>
<ul style="list-style-type: none"> <li>La pression d'air du réservoir dépasse le seuil de pression de redémarrage du moteur.</li> </ul>	<ul style="list-style-type: none"> <li>Le moteur va démarrer automatiquement quand la pression du réservoir sera tombée sous le seuil de redémarrage du compresseur.</li> </ul>
<ul style="list-style-type: none"> <li>La soupape de relâchement de pression du commutateur moteur/pression n'a pas déchargé la pression de la tête de pompe.</li> </ul>	<ul style="list-style-type: none"> <li>Purgez la conduite en passant le commutateur sur l'arrêt <b>OFF (0)</b>.</li> </ul>
<ul style="list-style-type: none"> <li>Moteur, condensateur de moteur, commutateur moteur/pression potentiellement défectueux.</li> </ul>	<ul style="list-style-type: none"> <li>Contactez le support à la clientèle de Senco.</li> </ul>
<ul style="list-style-type: none"> <li>Le cordon secteur n'est pas branché.</li> </ul>	<ul style="list-style-type: none"> <li>Connectez le cordon sur la prise secteur.</li> </ul>

### Symptôme 2 – Sur l'option démarrage/coupure (Start/Stop) le moteur tourne sans arrêts.

Cause Probable	Remède
<ul style="list-style-type: none"> <li>Le commutateur moteur/pression ne coupe pas le moteur quand la pression d'air du réservoir atteint le seuil haut et le soupape de sûreté doit se déclencher.</li> </ul>	<ul style="list-style-type: none"> <li>Passez le commutateur moteur/pression sur la position d'arrêt <b>OFF (0)</b>. Si le moteur ne se coupait pas, débranchez le compresseur d'air. Si les contacts électriques se sont soudés, remplacez le commutateur.</li> </ul>
<ul style="list-style-type: none"> <li>Le compresseur d'air est sous-dimensionné.</li> </ul>	<ul style="list-style-type: none"> <li>Limitez la pression de l'air à la capacité du compresseur d'air. Utilisez soit un outil moins puissant soit un compresseur d'air de plus forte capacité.</li> </ul>

### Symptôme 3 – L'air continue de fuir à la valve de purge du commutateur moteur/pression après l'arrêt du moteur.

Cause Probable	Remède
<ul style="list-style-type: none"> <li>Le clapet anti-retour est resté bloqué en position ouverte.</li> </ul>	<ul style="list-style-type: none"> <li>Démontez, nettoyez ou remplacez.</li> </ul>

### Symptôme 4 – L'air continue de fuir à la valve de purge du commutateur moteur/pression quand le moteur tourne.

Cause Probable	Remède
<ul style="list-style-type: none"> <li>Commutateur moteur/pression défectueux.</li> </ul>	<ul style="list-style-type: none"> <li>Remplacement.</li> </ul>

### Symptôme 5 – L'air fuit au niveau de la soupape de sûreté.

Cause Probable	Remède
<ul style="list-style-type: none"> <li>Possible soupape de sécurité défectueux.</li> </ul>	<ul style="list-style-type: none"> <li>Faites fonctionner la soupape de sûreté manuellement en tirant sur l'anneau. Si elle fuit toujours, il doit être remplacé.</li> </ul>
<ul style="list-style-type: none"> <li>Excessive de la pression du réservoir d'air.</li> </ul>	<ul style="list-style-type: none"> <li>Commutateur moteur/pression défectueux. Remplacement.</li> </ul>

## Dépannage

### Symptôme 6 – L'air fuit au niveau de raccords.

Cause Probable	Remède
<ul style="list-style-type: none"> <li>Les raccords ne sont pas assez serrés.</li> </ul>	<ul style="list-style-type: none"> <li>Resserrez les raccords là où vous entendez l'air s'échapper. Vérifiez l'étanchéité des raccords avec de l'eau savonneuse.</li> </ul>

### Symptôme 7 – L'air fuit au niveau du réservoir.

Cause Probable	Remède
<ul style="list-style-type: none"> <li>Réservoir défectueux ou percé par la rouille.</li> </ul>	<ul style="list-style-type: none"> <li>Il faut remplacer le réservoir d'air. N'essayez pas de réparer un réservoir d'air! Ne pas souder, effectuer des réparations ou modifications.</li> </ul>

### Symptôme 8 – L'air fuit au niveau du filtre d'entrée.

Cause Probable	Remède
<ul style="list-style-type: none"> <li>Soupape flexible d'admission défectueuse.</li> </ul>	<ul style="list-style-type: none"> <li>Contactez le service à la clientèle de Senco.</li> </ul>

### Symptôme 9 – Pression d'air comprimé insuffisante au niveau de l'outil ou accessoire.

Cause Probable	Remède
<ul style="list-style-type: none"> <li>Le bouton de réglage du régulateur n'est pas assez tourné côté pression plus élevée ou le régulateur de pression est défectueux.</li> </ul>	<ul style="list-style-type: none"> <li>Régalez le bouton du régulateur pour plus de pression, ou changez le régulateur.</li> </ul>
<ul style="list-style-type: none"> <li>Le filtre d'admission d'air est obstrué.</li> </ul>	<ul style="list-style-type: none"> <li>Nettoyez le filtre.</li> </ul>
<ul style="list-style-type: none"> <li>Il y a des fuites d'air.</li> </ul>	<ul style="list-style-type: none"> <li>Recherchez et réparez les fuites.</li> </ul>
<ul style="list-style-type: none"> <li>Le compresseur d'air n'est pas assez puissant pour la demande.</li> </ul>	<ul style="list-style-type: none"> <li>Vérifiez la consommation en air comprimé de l'accessoire. Si cette demande est supérieure à la production (pieds cubes par minute) du compresseur d'air, il vous faut un compresseur plus gros.</li> </ul>

### Symptôme 10 – Le compresseur d'air ne produit pas assez d'air comprimé.

Cause Probable	Remède
<ul style="list-style-type: none"> <li>Le filtre d'admission d'air est obstrué.</li> </ul>	<ul style="list-style-type: none"> <li>Nettoyez le filtre.</li> </ul>
<ul style="list-style-type: none"> <li>Soupape flexible d'admission défectueuse.</li> </ul>	<ul style="list-style-type: none"> <li>Purgez le réservoir d'air et mesurez le temps de fonctionnement de la pompe. Comparez-le aux spécifications. S'il est inférieur, démontez la tête de pompe et inspectez la plaque porte soupape, nettoyez ou remplacez.</li> </ul>

### Symptôme 11 – Humidité dans l'air en sortie.

Cause Probable	Remède
<ul style="list-style-type: none"> <li>Condensation dans le réservoir d'air causée par un niveau élevé d'hygrométrie atmosphérique, ou le fait que le compresseur d'air n'a pas tourné assez longtemps.</li> </ul>	<ul style="list-style-type: none"> <li>Purgez bien le réservoir d'air après chaque utilisation. Purgez-le plus souvent par temps humide et utilisez un filtre sur la conduite d'air.</li> </ul>

## Spécifications

Référence de modèle PC 1010		
<b>Moteur</b>	Puissance	.5 CV / 0.3 KW
	Tension	230 V
	Ampérage	2 A
	Fréquence	50 Hz
	Phase	Monophasé
	Vitesse de rotation	2850 tours/minute
<b>Pompe de compresseur</b>	Nombre de cylindres	1
	Étage de compression	1
	Carter	Aluminium
	Paliers	Billes
	Cylindre	Aluminium
	Soupapes	Flexible à ruban simple
	Tête	Aluminium
	Filtre	Insert
<b>Réglage du commutateur moteur/pression</b>	Seuil haut de coupure	8.6 bar (125 PSI)
	Seuil bas de démarrage	6.6 bar (95 PSI)
	Commandes	ON (1) / OFF (0)
<b>Réservoir d'air</b>	Capacité	3.8 Liter(1 Gallon)
<b>Performance globale</b>	L/Min Déplacement d'air	32 (1.1 CFM)
	L/Min @ 2.8 bar	17 (0.6 CFM @ 40 PSI)
	L/Min @ 6.2 bar	10 (0.35 CFM @ 90 PSI)
	L/Min @ 6.9 bar	9 (0.31 CFM @ 100 PSI)
	Pression maximale	8.6 bar (125 PSIG)
	Temps d'activation de pompe: 0-9 bar	160 secondes
	Temps de récupération : 7-9 bar	48 secondes
<b>Poids</b>	Net	9.1 kg
<b>Dimensions</b>	Longueur x largeur x hauteur	36 x 33 x 25 cm
<b>Noise</b>	Measured sound power level (dB)	78 dBA
	Guaranteed sound power level (dB)	81 dBA

## Déclaration De Conformité

Nous, Senco Brands, Inc.,  
 sis au 4270 Ivy Pointe Blvd., Cincinnati, Ohio 45245  
 conformément à la (aux) directive(s) suivante(s) :

**Machine Directive 2006/42/EC**  
**Pressure Vessel Directive 2009/105/EC.**  
**EMC Directive 2004/108/EC**  
**Low Voltage Directive 2006/95/EC**  
**RoHS Directive 2011/65/EU**  
**Noise Emission Directive 2005/88/EC**

déclarons, en vertu de notre responsabilité exclusive, ce qui suit: Modèle(s):  
**PC 1010 EU, PC 1010EU-2P, PC 1010EUS, PC 1010EUS-UK110,**  
**PC 1010PL, PC 1010S, PC 1010UK1, PC 1010UK2**

est conforme aux exigences essentielles applicables en matière de santé et de sécurité, telles que stipulées dans les documents ci-dessous :  
**EN ISO 14121-1:2007, EN ISO 3744:1995, EN ISO 4871:2009,**  
**EN1012-1:2010, EN 60204-1:2006+A1:2009, EN286-1:1998**

Signé par : Chris Klein  
 Poste : Directeur de l'ingénierie  
 Lieu du document : Senco Brands, Inc.  
 4270 Ivy Pointe Blvd., Cincinnati, Ohio 45245  
 Version initiale: 4 Septembre 2014  
 Représentant autorisé:  
 (à compiler le fichier technique)  
 Nom: Peter van der Wel  
 Adresse: Senco Brands B.V.  
 Geurdeland 17E, 6673 DR Andelst, The Netherlands

**1. Senco Professional End User Warranty Policy**

Considering the following constraints Senco underwrites the reliability and the quality of its supplied authorised Senco branded products.

1.1 Senco warrants to the end user that the following products will be free from defects in construction, assembly and material for the warranty period specified below.

Product	Warranty period
Senco ® XP Series-Red Cap, pneumatic tools	Five years
Senco ® XP Series-Black Cap, pneumatic tools	Two years
Senco Pro Series, pneumatic tools	One year
Senco Semi-Pro Series, pneumatic tools	One year
Senco DuraSpin ® Series, electric and battery tools	One year
Senco Cordless battery tools	Two years
Senco batteries and chargers for tools	One year
Senco gas tools	Two years
Senco Reconditioned Products	One year
Senco other tools	One year
Senco Compressors	One year

1.2 The warranty period starts on the day the end user purchases the product and/or 1 year after the tool has been deleted from the product line, whichever date comes first.

1.3 To claim warranty the end user needs to send the defective products or their parts, including the serial number and the original and dated sales receipt or proof of purchase from the original retailer or dealer, freight prepaid to the original retailer or dealer.

1.4 Senco is not obliged to do any repairs or replacements on any products or their parts on site.

1.5 During the warranty period Senco or its distributors will repair or replace defective products or their parts, exclusively or mainly as a result of an imperfection in construction, assembly or material, at Senco's option and expense, subject to the constraints of this warranty policy.

1.6 The repair or replacement of products or their parts under warranty, does in no case lead to prolongation of the warranty period. For every replacement product or part, the remaining original warranty period of the replaced product or part is applicable.

1.7 Senco will become the owner of the products or parts that have been replaced by Senco or its distributors as a result of being compliant to Senco's warranty, without being obligated any compensation in this matter.

1.8 Excluded from the warranty are:

- Normal wear and tear parts, for example rubber o-rings, seals, driver blades, piston stops, piston/driver assemblies, isolators, drive belts, air filters and fuel systems, bits;
- Any imperfection that is a result of or has evolved from the fact that there has not been used clean, dry regulated compressed air and/or the air pressure applied has exceeded the maximum indicated on the tool casting (pneumatic tools);
- Any imperfection that is a result of or has evolved from normal wear, misapplication, abuse/misuse, improper modifications or storage, shipping/transport, accidents, neglect, operation at other than recommended speeds or voltage (electric units only);
- Any imperfection that is a result of or has evolved from explosions, fires and natural disasters, like hurricanes, floods and earthquakes;
- Any imperfection that is a result of or has evolved from not following operating instructions, specifications and / or maintenance schedules. Read the Operator Manual for use, specifications and maintenance instructions;
- Any imperfection that is caused by repairs, modifications to the product or attempts to do so by the end user or any third party;
- Labour charges or loss or damage resulting from improper operation, maintenance or repairs are not covered by this warranty
- Any warranty claims that have been received after the warranty period, as specified in this end user warranty, has expired.

1.9 Additional costs like shipping/transport, special packaging requirements and costs of travel and accommodation, are at the end users expense.

1.10 If a complaint is unfounded, all costs incurred thereby, including handling, inspection, shipping and administrative costs on the side of Senco or its distributors, will be charged to the end user.

1.11 After expiration of the warranty period, all costs for repair or replacement, including handling, inspection, shipping and administrative costs will be charged to the end user.

1.12 Notwithstanding legal limitation periods, the limitation of all claims and appeals against Senco and third parties involved by Senco for the implementation of the agreement is one year.

1.13 If Senco fails to meet this agreement, it will not discharge the end user from the obligations arising under this or any other contract.

1.14 When the warranty terms can not be met, due to for example import or export prohibitions, strikes or other unforeseen circumstances, the warranty period will be extended accordingly.

1.15 Senco's liability is limited to the warranty. Senco is not liable for damage caused by the functioning or non-functioning of the products as delivered, repaired or modified by Senco or its distributors, including but not limited to, production losses, profit losses, reduced working range, commercial losses or consequential damages or indirect damages whatsoever.

## Compresseur D'aire Électrique

### Parts Reference Guide

NO:RLB-1409

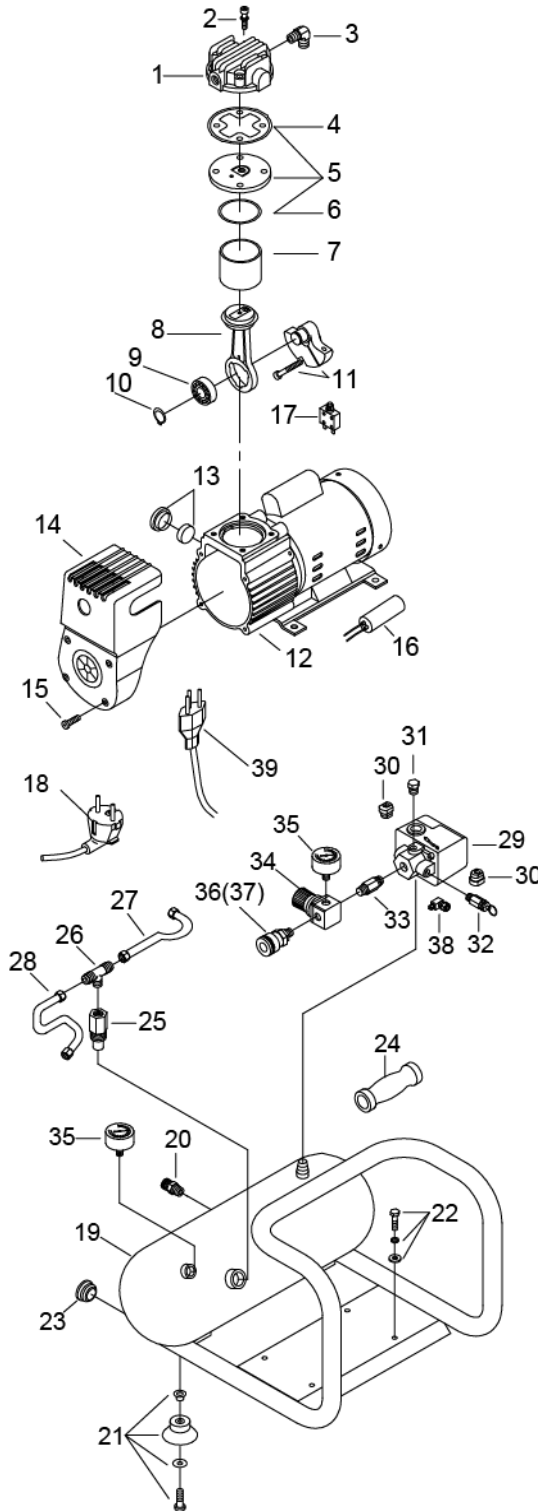

Ref. No.	Description	Part No.	Qty.
1	CYLINDER HEAD	3101063A	1
2	ALLEN BOLT SET	3B01-M05*060V	4
3	EXHAUST ELBOW	2N06-01T02H	1
4	CYLINDER HEAD GASKET	2G01-025H	1
5	EXHAUST VALVE ASSEMBLY	3B11-DC02A	1
6	VALVE SEAT GASKET	2G03-018	1
7	CYLINDER	3201068	1
8	ROD ASSEMBLY	3B3-MB02	1
9	BEARING	2N35-6201ZZC3	1
10	CLIP	2N42-S12	1
11	CRANKSHAFT & BALANCER	3304086	1
12	MOTOR SET	3B8-MB0206S	1
13	AIR FILTER SET	2140026RS	1
14	SHROUD	2428015RS	1
15	BOLT	2B02-FM4*015B	4
16	RUNNING CAPACITOR	2E27-004F4525	1
17	CIRCUIT BREAKER	2E25-01AS	1
18	POWER CABLE (2 PIN)	2E01-029S	1
19	AIR TANK	3401174U	1
20	DRAIN VALVE	2405012	1
21	RUBBER PAD SET	3433011-ARS	4
22	HEXAGON BOLT SET	3B00-FM06*012RS	4
23	PLUG	2N32-W07RS	2
24	GRIP	2432107	1
25	CHECK VALVE	2414033A	1
26	UNLOADING 3-WAY PIPE	2N09-02H01T02H4	1
27	UNLOADING TUBE	3B2-02*190F	1
28	DISCHARGE TUBE	2T02-02*0260RS	1
29	PRESSURE SWITCH	2E21-AA256BPS	1
30	STRAIN RELIEF BUSHING	2E04-008	2
31	PLUG	2N33-009	1
32	PRESSURE RELIEF VALVE	2406021A	1
33	NIPPLE	2N01-058RS	1
34	REGULATOR	2408008RRS	1
35	PRESSURE GAUGE	2D12-15D14BAR	2
36	QUICK COUPLER (FOR PC1010EU ONLY)	07S1/4M-ERS	1
37	QUICK COUPLER (FOR PC1010EU COMBO KIT, PC1010S, 6PR2001N)	07OS1/4M-C	1
38	UNLOADING VALVE	2409015	1
39	POWER CABLE (3 PIN)	2E01-044S	1



# Compresor de aire eléctrico

## Instrucciones De Empleo

(La Traducción De  
Las Instrucciones Originales)



# SENCO<sup>®</sup>

Senco Brands, Inc.  
4270 Ivy Pointe Blvd.  
Cincinnati, OH 45245  
1-800-543-4596  
[www.senco.com](http://www.senco.com)  
EMEA: [www.senco-emea.com](http://www.senco-emea.com)



En este manual se incluyen avisos para el uso seguro de este compresor.



Lea y comprenda todas las instrucciones.

PC1010 • Revisado 11 de Marzo 2015 (Reemplaza 1/24/2013)

## Indice

Introducción.....	3
Inspección .....	3
Medidas De Seguridad.....	4
Características Del Compresor .....	8
Preparación.....	10
Montaje Inicial.....	10
Emplazamiento .....	10
Sistema Eléctrico .....	10
Funcionamiento.....	11
Lista De Comprobación Antes De La Puesta En Marcha .....	11
Puesta En Marcha .....	11
Parada .....	11
Mantenimiento.....	11
Localización Y Solución De Averías .....	12
Especificaciones .....	14
Declaración De Conformidad .....	14
Garantía Limitada.....	15
Parts Reference Guide.....	16

## Introducción

¡Lo felicitamos por la compra de su nuevo compresor de aire SENCO®! Puede tener la seguridad de que su compresor de aire SENCO fue construido con el más alto nivel de precisión y exactitud. Cada componente fue sometido a pruebas rigurosas por los técnicos para garantizar la calidad, duración y rendimiento de este compresor de aire.

Este manual del operador fue redactado para su beneficio. Al leer y respetar los sencillos pasos de seguridad, instalación, operación y mantenimiento descritos en este manual, disfrutará de muchos años de funcionamiento sin problemas de su nuevo compresor de aire SENCO. El contenido de este manual está basado en la información más reciente del producto disponible al momento de la publicación. El fabricante se reserva el derecho de hacer cambios en el precio, el color, los materiales, el equipo, las especificaciones o los modelos en cualquier momento sin previo aviso.



### Aviso De Seguridad!

Un aviso de seguridad titulado "PELIGRO, ADVERTENCIA o ATENCIÓN" estará encuadrado en un "AVISO DE SEGURIDAD". Este encuadre se utiliza para designar y recalcar los avisos de seguridad que deben respetarse cuando se maneja este compresor de aire. Los avisos de seguridad van acompañados de "palabras de aviso" que designan el grado o nivel de la gravedad del riesgo. Las "palabras de aviso" que se utilizan en este manual son las siguientes:

**Peligro:** Indica una situación inminentemente peligrosa que, si no se evita, RESULTARÁ en lesiones graves o muerte.

**Avertencia:** Indica una situación potencialmente peligrosa que, si no se evita, PODRÍA resultar en lesiones graves o muerte.

**Atencion:** Indica una situación potencialmente peligrosa que, si no se evita, PUEDE resultar en lesiones leves o moderadas o daño al compresor de aire.

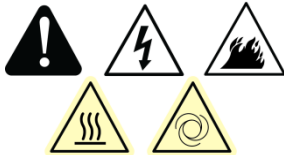

Estos símbolos se usan para llamar la atención hacia artículos o procedimientos que podrían ser peligrosos para usted u otras personas que estén utilizando este equipo.

**PROPORCIONE SIEMPRE UN EJEMPLAR DE ESTE MANUAL A TODA PERSONA QUE UTILICE ESTE EQUIPO.**

**ANTES DE MANEJAR ESTE COMPRESOR DE AIRE, LEA TODAS LAS INSTRUCCIONES EN ESTE MANUAL Y AQUELLAS SUMINISTRADAS POR LOS FABRICANTES DE LOS EQUIPOS SUPLEMENTARIOS, Y DESTAQUE ESPECIALMENTE LAS "MEDIDAS DE SEGURIDAD" PARA PREVENIR LA POSIBILIDAD DE LESIONES AL OPERADOR.**

## Inspección

Desembale el compresor de aire y anote el número de serie en el espacio más abajo provisto para ese fin. Inspeccione para ver si hay indicios de daños obvios u ocultos ocurridos durante el transporte. Antes de hacer funcionar el compresor de aire, asegúrese de reemplazar todas las piezas dañadas y reparar las averías mecánicas.

**NÚMERO DE SERIE** \_\_\_\_\_

Para consultas o comentarios, llame sin cargo a la línea de asistencia de SENCO: **1-800-543-4596** ó envíe e-mail a: [toolprof@Senco.com](mailto:toolprof@Senco.com)

Por favor tenga la información siguiente a mano para todas las llamadas de servicio:



1. Número de modelo
2. Número de serie
3. Fecha y lugar de compra

Senco, 4270 Ivy Pointe Blvd., Cincinnati, OH 45245

## Medidas De Seguridad





**Lea Todas Las Medidas De Seguridad Antes De Usar El Compresor De Aire**

Riesgo	Consecuencia Potencial	Prevención
<p style="text-align: center;"><b>Riesgo De Electrochoque O Electrocutación</b></p> <div style="text-align: center;">      </div>	<ul style="list-style-type: none"> <li>• Si no se conecta a tierra correctamente el compresor de aire, podrían ocurrir lesiones graves o la muerte. Su compresor de aire es alimentado por electricidad y puede causar electrochoque o electrocución si no se usa debidamente.</li> </ul>	<ul style="list-style-type: none"> <li>• Asegúrese de que el compresor de aire está enchufado a un tomacorriente correctamente conectado a tierra y que suministra el voltaje correcto y la protección adecuada mediante fusibles. Revise el cordón de alimentación para ver si hay indicios de aplastamiento, cortes o daños por calor. Reemplace el cordón defectuoso antes de usar el compresor.</li> </ul>
	<ul style="list-style-type: none"> <li>• El cordón eléctrico puede causar electrochoque.</li> </ul>	<ul style="list-style-type: none"> <li>• Mantenga todas las conexiones secas y elevadas del suelo. No deje que los cordones eléctricos queden en el agua o en una posición donde pudieran quedar en contacto con agua. No toque el enchufe con las manos mojadas.</li> </ul>
	<ul style="list-style-type: none"> <li>• Puede ocurrir electrochoque si no se maneja correctamente el compresor de aire.</li> </ul>	<ul style="list-style-type: none"> <li>• No tire del cordón eléctrico para desenchufarlo del tomacorriente. No maneje nunca el compresor de aire en condiciones mojadas o a la intemperie cuando está lloviendo. No maneje nunca el compresor de aire con los protectores o cubiertas fuera de lugar o dañados.</li> <li>• Toda conexión de cableado o reparación eléctrica en este compresor de aire debe ser ejecutada por personal de servicio autorizado y de acuerdo con los códigos eléctricos nacionales y locales.</li> </ul>
	<ul style="list-style-type: none"> <li>• Pueden ocurrir lesiones graves o la muerte si personas sin experiencia intentan hacer las reparaciones eléctricas.</li> </ul>	<ul style="list-style-type: none"> <li>• Antes de abrir un caja de conexiones eléctricas, apague siempre el compresor de aire, descargue la presión y desenchufe el compresor de la fuente de alimentación. Deje que el compresor de aire se enfríe. Nunca dé por supuesto que puede trabajar sin peligro en el compresor de aire, simplemente por que no está funcionando. ¡Podría arrancar en cualquier momento</li> </ul>

## Medidas De Seguridad



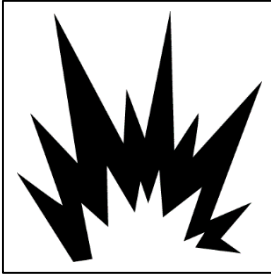



**Lea Todas Las Medidas De Seguridad Antes De Usar El  
Compresor De Aire**

Riesgo	Consecuencia Potencial	Prevención
<p style="text-align: center;"><b>Riesgo De Explosión O Incendio</b></p> <div style="text-align: center;">     </div>	<ul style="list-style-type: none"> <li>• Las chispas eléctricas que ocurren normalmente en el motor y el interruptor de presión puede causar lesiones graves o la muerte.</li> <li>• Pueden ocurrir graves lesiones si cualquiera de los orificios de venteo del compresor se obtura, causando el sobrecalentamiento e incendio del compresor de aire.</li> </ul>	<ul style="list-style-type: none"> <li>• Utilice siempre el compresor de aire en un lugar bien ventilado libre de vapores inflamables, polvo combustible, gases u otros materiales combustibles.</li> <li>• Si está pulverizando con un material inflamable, sitúe el compresor de aire a por lo menos 6 meters de distancia de la zona de pulverización. (Es posible que se necesite una manguera adicional.)</li> <li>• Nunca coloque objetos afirmados contra el compresor de aire o encima del mismo. Utilice el compresor de aire a por lo menos 30cm de distancia de la pared u obstrucción que pudiera restringir la ventilación adecuada.</li> </ul>
<p style="text-align: center;"><b>Riesgo De Estallido</b></p> <div style="text-align: center;">  </div>	<ul style="list-style-type: none"> <li>• Pueden ocurrir lesiones graves o la muerte si el tanque de aire llegara a explotar por falta de mantenimiento adecuado.</li> <li>• Pueden ocurrir lesiones graves a causa de una avería del compresor de aire o explosión de los accesorios por el uso de componentes, implementos o accesorios incorrectos.</li> </ul>	<ul style="list-style-type: none"> <li>• Vacíe el tanque de aire diariamente o después de cada uso para evitar la acumulación de humedad en el tanque.</li> <li>• Si el tanque comienza a perder aire, cámbielo inmediatamente. Nunca repare, suelde o haga modificaciones al tanque de aire o sus accesorios. Nunca cambie los ajustes de presión de fábrica.</li> <li>• Nunca sobrepase las capacidades máximas de presión admisibles dlos accesorios.</li> <li>• Debido al calor extremo, no use tubería de plástico ni juntas estañosoldadas en el tubo de descarga.</li> <li>• Nunca use el compresor de aire para inflar objetos pequeños de baja presión tales como juguetes.</li> <li>• Todas las mangueras y guarniciones serán convenientes para el uso del sitio en la presión de funcionamiento máxima permitida del compresor portable.</li> <li>• Utilice sólo recambios originales de SENCO para su compresor de aire.</li> </ul>

## Medidas De Seguridad





**Lea Todas Las Medidas De Seguridad Antes De Usar El  
Compresor De Aire**

Riesgo	Consecuencia Potencial	Prevención
<p style="text-align: center;"><b>Riesgo Para Las Vías Respiratorias</b></p> 	<p>Podrían ocurrir lesiones graves o la muerte si se inhala el aire comprimido. El chorro de aire puede contener monóxido de carbono, vapores tóxicos o partículas sólidas.</p> <p>Los materiales aplicados con pulverizador tales como pintura, diluyentes de pintura, quitapinturas, insecticidas, matamalezas, etc. contienen vapores nocivos y venenos.</p>	<p>Nunca inhale el aire del compresor de aire ya sea directamente o a través un aparato respirador conectado al compresor de aire.</p> <p>Utilice el compresor de aire solamente en un lugar bien ventilado. Siga todas las instrucciones de seguridad suministradas con los materiales que está pulverizando. Es posible que tenga que usar un respirador cuando trabaje con ciertos materiales.</p>
<p style="text-align: center;"><b>Riesgo De Quemaduras</b></p> 	<ul style="list-style-type: none"> <li>• Podrían ocurrir lesiones graves si se tocan las piezas metálicas al descubierto.</li> <li>• Estas partes pueden permanecer calientes por algún tiempo después de apagar el compresor de aire.</li> </ul>	<ul style="list-style-type: none"> <li>• No permita que ninguna parte de su cuerpo u otros materiales queden en contacto con las piezas metálicas descubiertas en el compresor de aire, motor o tubería.</li> </ul>
<p style="text-align: center;"><b>Riesgo De Ser Golpeado Por Objetos Volantes</b></p> 	<ul style="list-style-type: none"> <li>• El chorro de aire comprimido puede dañar los tejidos blandos.</li> </ul>	<ul style="list-style-type: none"> <li>• Use siempre gafas de seguridad Z87" e los "exigidas por OSHA para protegerse los ojos contra los residuos volantes.</li> <li>• Nunca dirija el chorro de aire contra su cuerpo u otras personas o animales.</li> <li>• Nunca deje el compresor de aire presurizado desatendido. Apague el compresor de aire y descargue la presión antes de intentar hacer trabajos de mantenimiento, conectar herramientas o accesorios.</li> </ul>
<p style="text-align: center;"><b>Use Siempre Protección Para Los Ojos</b></p> 	<ul style="list-style-type: none"> <li>• Pueden ocurrir lesiones graves a causa de residuos sueltos lanzados a gran velocidad por el chorro de aire comprimido.</li> </ul>	<ul style="list-style-type: none"> <li>• Manténgase siempre a una distancia segura de personas y animales mientras utiliza el compresor de aire.</li> <li>• No traslade el compresor de aire mientras el tanque está presurizado. No intente mover el compresor de tirándolo de la manguera.</li> </ul>

## Medidas De Seguridad

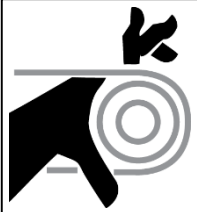

**Lea Todas Las Medidas De Seguridad Antes De Usar El  
Compresor De Aire**

Riesgo	Consecuencia Potencial	Prevención
<p style="text-align: center;"><b>Riesgo De Las Piezas En Movimiento</b></p> <div style="text-align: center;">  </div> <p style="text-align: center;"><b>Cuidado: La Unidad Puede Arrancar Sin Previo Aviso</b></p> <div style="text-align: center;">  </div>	<ul style="list-style-type: none"> <li>Riesgo de ser lesionado por las piezas en movimiento. Este compresor de aire funciona automáticamente cuando el interruptor de presión está en la posición de <b>ON (1)</b>/Auto (encendido/automático).</li> </ul>	<ul style="list-style-type: none"> <li>Apague siempre el compresor de cuando no esté en uso. Antes de hacer trabajos de mantenimiento, purgue la presión de la manguera aire y desenchufe el cordón eléctricodel tomacorriente. Todas las reparaciones del compresor de aire debe hacerlas una técnico de servicio autorizado. Nunca dé por supuesto que no es peligroso trabajar en el compresor de aire, simplemente porque no está funcionando. ¡Puede arrancar imprevistamente en cualquier momento!</li> </ul>
<p style="text-align: center;"><b>Riesgo Por Negligencia</b></p> <div style="text-align: center;">  </div>	<ul style="list-style-type: none"> <li>Riesgo de lesionarse debido al uso descuidado.</li> </ul>	<ul style="list-style-type: none"> <li>No lo utilice sin que tenga instaladlas cubiertas o protectores. Reemplace las cubiertas y los protectores antes de usar el compresor de aire.</li> <li>¡Nunca permita que niños o adolescentes usen este compresode aire!</li> </ul>
<p style="text-align: center;"><b>Riesgo De Dañar El Compresor De Aire</b></p>	<ul style="list-style-type: none"> <li>Riesgo de reparaciones importantes.</li> </ul>	<ul style="list-style-type: none"> <li>Manténgase alerta - preste atención que está haciendo.</li> <li>No use el compresor de aire cuanestá fatigado o ha tomado bebidas alcohólicas o drogas.</li> <li>Sepa cómo parar el compresor de aire. Aprenda bien el manejo de locontroles.</li> <li>No use el compresor de aire sin el filtro de aire.</li> <li>No use el compresor de aire en un ambiente corrosivo.</li> <li>Coloque siempre el compresor de aire en posición estable y segura para evitar que se caiga mientras está funcionando.</li> <li>Siga todas las instrucciones de mantenimiento presentadas en esmanual.</li> </ul>

**¡GUARDE ESTAS INSTRUCCIONES!**

## Características Del Compresor

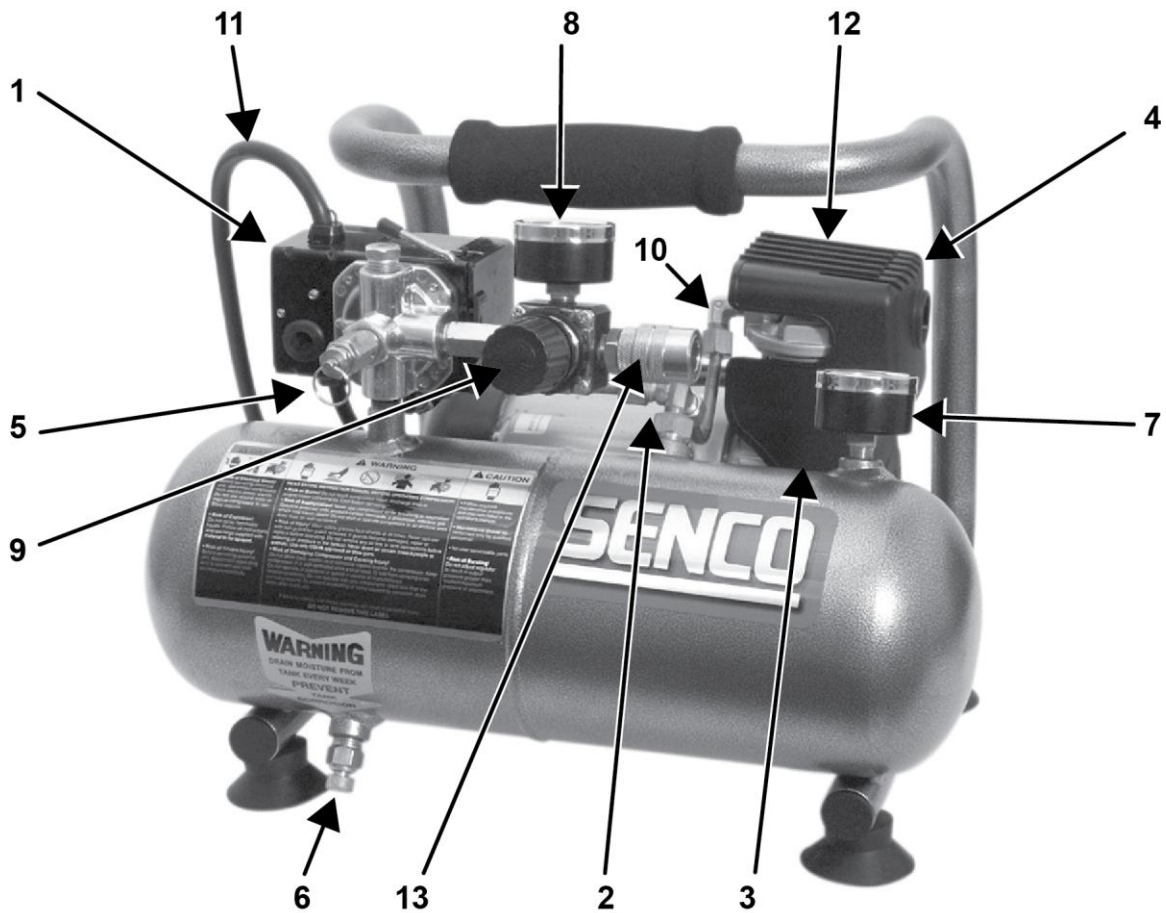

1.	Interruptor de motor/presión
2.	Protector contra sobrecarga térmica/Reposición
3.	Filtro de admisión de aire
4.	Bomba del compresor de aire
5.	Válvula de seguridad
6.	Válvula de purga del tanque de aire
7.	Manómetro del tanque
8.	Manómetro de presión de salida
9.	Regulador de presión
10.	Tubo de descarga
11.	Cordón de alimentación
12.	Orificios de venteo/cubierta protectora
13.	Desacople rápido



## Características Del Compresor

**1) Interruptor Del Motor/Presión:** Este interruptor se usa para arrancar o parar (apagar) el compresor de aire. Al moverlo a la posición **ON (1)** (encendido) se suministra alimentación automática al interruptor de presión lo que permitirá que el motor arranque cuando la presión del tanque de aire está por debajo de la presión de "activación" ajustada en fábrica. Cuando se coloca en la opción de **ON (1)** Option (arranque/parada), el interruptor de presión apaga el motor cuando la presión del tanque de aire llega a la presión de "desactivación" ajustada en fábrica. Para fines de seguridad, este interruptor también tiene una válvula de seguridad de presión ubicada en el costado del interruptor, diseñada para descargar automáticamente el aire comprimido del cabezal de la bomba del compresor y su tubo de descarga cuando el compresor llega a la presión de "desactivación" o se apaga el motor. Esto permite que el motor vuelva a arrancar libremente. Al mover el interruptor a la posición **OFF (0)** (apagado) se corta la alimentación al interruptor de presión y se apaga el compresor de aire.

**2) Sobrecarga Del Motor:** El motor tiene un disyuntor protector ubicado en la bomba. El consumo excesivo de amperaje causará el disparo del disyuntor para proteger al operador y motor. Reposicione el disyuntor oprimiendo el vástago de plástico negro hacia dentro de la caja. Reposicione el disyuntor si se ha disparado.

**3) Filtro De Admisión De Aire:** El filtro está diseñado para limpiar el aire que entra a la bomba. Para asegurar que la bomba recibe continuamente un suministro de aire seco, frío y limpio, este filtro debe estar siempre limpio y los orificios de venteo libres de obstrucciones. El filtro puede sacarse para limpiarlo con agua tibia jabonosa. Enjuague el filtro y déjelo secar al aire.

**4) Bomba Del Compresor De Aire:** Para comprimir el aire, el pistón sube y baja en el cilindro. En la carrera descendente, la válvula de admisión aspira aire del exterior mientras la válvula de escape permanece cerrada. En la carrera ascendente, el aire se comprime, la válvula de admisión se cierra y el aire comprimido es forzado al exterior a través de la válvula de escape al tubo de descarga, a través de la válvula de retención (antirretorno) y al interior del tanque de aire.

**5) Válvula De Seguridad:** Esta válvula está diseñada para evitar fallas en el sistema, descargando la presión del sistema cuando el aire comprimido llega a un nivel predeterminado. La válvula es preajustada por el fabricante y no debe modificarse de manera alguna. Para verificar si la válvula está funcionando correctamente, tire del anillo. Deberá escapar presión de aire. Al soltar el anillo, se reasentará.

**6) Válvula De Purga Del Tanque De Aire:** Esta válvula se usa para purgar la humedad del tanque (tanques) de aire después que se apaga el compresor de aire. **NUNCA intente abrir la válvula de purga cuando la presión en el tanque es superior a 0.7 bar!** Para abrir la válvula de purga, gire la perilla en sentido contrario a las agujas del reloj. Inclíne el tanque para asegurarse que toda la condensación se vacía a través de la válvula.

**7) Manómetro Del Tanque De Aire:** Este manómetro indica la presión de aire de reserva en el tanque (tanques) de aire.

**8) Manómetro De Presión De Salida:** Este manómetro indica la presión de aire disponible en el lado de salida del regulador. Esta presión la controla el regulador y siempre es menor o igual que la presión del tanque de aire.

**9) Regulador De Presión:** La presión de aire proveniente del tanque de aire se controla mediante la perilla del regulador. Gire la perilla de regulación en sentido de las agujas del reloj para aumentar la presión de descarga, y en sentido contrario para disminuirla. Consulte el manual de instrucciones para el rango de presión recomendado.

**10) Tubo De Descarga:** Sírvase notar que el tubo de descarga está muy caliente. **Superficies calientes - No quitar la cubierta. Temperaturas elevadas después de un sustancial uso del mismo.**

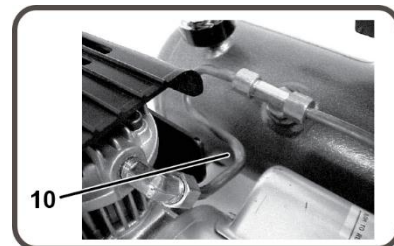
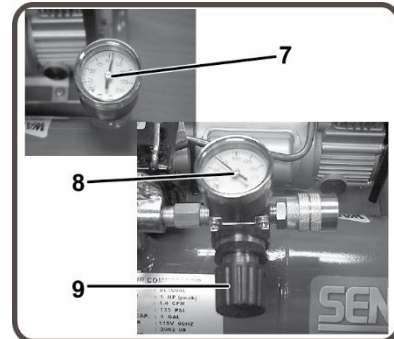
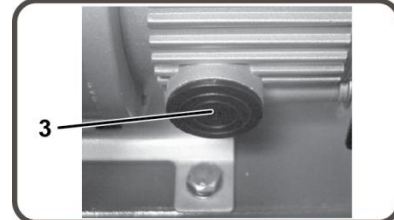
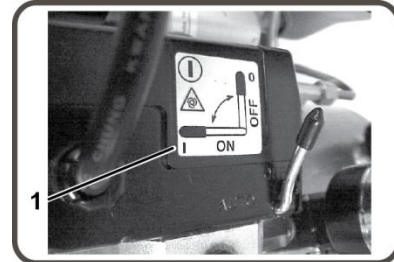

## Preparación

### Montaje Inicial

1. Lea las medidas de seguridad antes de montar el compresor de aire.

### Emplazamiento

**Atención** Para evitar dañar el compresor de aire, no lo incline más de 10° en sentido transversal o longitudinal.

1. Coloque el compresor de aire a una distancia de por lo menos 30cm de obstáculos que pudieran impedir la ventilación adecuada.

No coloque el compresor de aire en un lugar:

- Donde hay evidencia de fugas de aceite o gas.
- Donde puedan haber materiales o vapores de gas inflamables.

**Advertencia** Podrían ocurrir graves lesiones o la muerte si las chispas eléctricas del interruptor del motor y presión llegan a quedar en contacto con vapores inflamables, polvo combustible, gases u otros materiales combustibles. Cuando use el compresor de aire para pintar con pistola, colóquelo tan lejos como sea posible del lugar de trabajo, utilizando mangueras de aire adicionales en lugar de cordones eléctricos de extensión.



- Donde las temperaturas ambientales son inferiores a 0C o superiores a 40C.
- Donde existe la posibilidad de aspirar aire o agua extremadamente sucio al compresor.

### Sistema Eléctrico

**Peligro**



La conexión incorrecta del equipo-conductor de conexión a tierra puede resultar en riesgo de electrochoque o electrocución. Ante cualquier duda respecto a la conexión a tierra del tomacorriente, consulte con un perito electricista o técnico de servicio. No use ningún tipo de adaptador con este producto. En caso de ser necesario reparar o reemplazar el cordón o enchufe, no conecte el alambre de tierra a ninguno de los terminales de bayoneta planos. El alambre con aislamiento de superficie exterior de color verde con o sin rayas amarillas, es el alambre de tierra.

**Advertencia**



Este producto debe estar conectado a tierra. En el caso de ocurrir un malfuncionamiento o falla, la conexión a tierra proporciona un paso de menor resistencia para la corriente eléctrica con el fin de reducir el riesgo de electrochoque. Este producto está equipado con un cordón que tiene un conductor de conexión a tierra del equipo y un enchufe tipo conexión a tierra. El enchufe con conexión a tierra debe enchufarse a un tomacorriente correctamente instalado y conectado a tierra de acuerdo con todos los códigos y ordenanzas respectivos.

1. Senco® NO RECOMIENDA EL USO DE CORDONES DE EXTENSIÓN, ya que esto puede crear pérdida de potencia y sobrecalentamiento del motor. Se recomienda el uso de una manguera de aire adicional en vez de un cordón de extensión. Si el uso de un cordón de extensión es inevitable, se deberá enchufar en un interruptor accionado por corriente de pérdida a tierra (GFCI) encontrado en las cajas de circuitos o receptáculos protegidos.

Cuando use un cordón de extensión, respete lo siguiente:

<u>Longitud del cable</u>	<u>Calibre del alambre</u>
Hasta 8 meters	12 AWG
Hasta 30 meters	10 AWG
Hasta 50 meters	8 AWG
Hasta 75 meters	6 AWG

Use solamente cordones de extensión de una capacidad eléctrica no inferior a la capacidad nominal del producto. No use cordones de extensión dañados. Examine el cordón de extensión antes de usarlo, y cámbielo si está dañado. No maltrate el cordón de extensión y no tire de él para desenchufarlo. Mantenga el cordón lejos del calor y los cantos agudos. Apague siempre el interruptor del compresor de aire antes de desenchufar el enchufe del tomacorriente.

## Funcionamiento

### Lista De Comprobación Antes De La Puesta En Marcha

1. Quite toda la humedad del tanque de aire del compresor. Descargue el exceso de presión con una herramienta neumática y después abra la válvula de purga ubicada en la parte inferior del tanque. Para reducir presión excesiva tire del anillo de seguridad de la válvula de purga o utilice una pistola de aire. Luego abra la válvula de purga situada en el fondo del tanque de aire. Cíerrela bien apretada después de purgar.



**Advertencia: Riesgo de lesiones corporales. ¡NUNCA intente abrir la válvula de vaciado cuando la presión en el tanque es superior a 0.7 bar!**

2. Asegúrese que el interruptor del motor del compresor de aire esté en la posición **OFF (0)** (apagado).
3. Asegúrese que todas las válvulas de seguridad estén funcionando correctamente.
4. Asegúrese que todos los protectores y cubiertas estén en su lugar y firmemente instalados.

### Puesta En Marcha

1. Asegúrese que la palanca en la caja del interruptor de presión esté en la posición **OFF(0)** (apagado).
2. Enchufe el cordón de alimentación en un tomacorriente conectado a tierra.
3. Mueva la palanca en la caja del interruptor de presión a la posición **ON (1)** (automático).
4. Esto permitirá que el compresor de aire **Arranque** para aumentar la presión en los tanques de aire y que **Pare** cuando llega a la presión correcta. Cuando la presión disminuye con el uso, el compresor de aire **Arranca** para aumentar la presión nuevamente.
5. Ajuste la presión moviendo la perilla del regulador de presión en sentido contrario a las agujas del reloj para reducir la presión y en sentido de las agujas del reloj para aumentarla.
6. Si nota cualquier ruido o vibración fuera de lo normal, apague el compresor de aire y consulte la sección "Localización Y Solución De Averías."



### Parada

1. Para apagar el compresor de aire, mueva la palanca en la caja del interruptor de presión a la posición **OFF (0)** (apagado). No apague NUNCA el compresor de aire desenchufándolo de la fuente de alimentación. Al hacerlo corre el riesgo de electrocutarse.
2. Purgue el aire del tanque, utilizando una llave neumática conectada al compresor o tirando del anillo de la válvula de seguridad.
3. Una vez que la presión en los tanques de aire indica menos de 0.7 bar, abra la válvula de vaciado, ubicada debajo de cada tanque, para vaciar la humedad.
4. Deje que el compresor de aire se enfríe.
5. Limpie el compresor con un trapo y guárdelo en un lugar seguro y no expuesto a congelación.

## Mantenimiento

Lea el manual de instrucciones antes de efectuar trabajos de mantenimiento. Ejecute los procedimientos siguientes cuando pare el compresor de aire para mantenimiento o servicio.

1. Apague el compresor de aire.

**Advertencia: Nunca suponga que no es peligroso trabajar en el compresor de aire simplemente porque no está funcionando. ¡Puede arrancar imprevistamente en cualquier momento!**

2. Desconecte el cordón de la fuente de alimentación principal.
3. Abra todas las válvulas de purga.
4. Espere que el compresor de aire se enfríe antes de comenzar el mantenimiento.

Cuadro De Mantenimiento			
Procedimiento	Diario	Semanal	Mensual
Vaciar la condensación del tanque (tanques) de aire	X		
Revisar si hay ruidos o vibración fuera de lo común	X		
Revisar si hay fugas de aire	X		
Inspeccionar el filtro de aire		X	
Limpiar el exterior del compresor		X	
Revisar la válvula de seguridad			X

## Localización Y Solución De Averías

### Síntoma 1. El motor no funciona ni vuelve a arrancar.

Causa Probable	Solución
<ul style="list-style-type: none"> <li>El cordón de alimentación no está enchufado.</li> </ul>	<ul style="list-style-type: none"> <li>Enchufar el cordón en un tomacorriente conectado a tierra.</li> </ul>
<ul style="list-style-type: none"> <li>El interruptor del motor/presión está en posición <b>OFF (0)</b> (apagado).</li> </ul>	<ul style="list-style-type: none"> <li>Mover el interruptor a la posición <b>ON (1)</b> (encendido).</li> </ul>
<ul style="list-style-type: none"> <li>El interruptor de sobrecarga térmica del motor se disparó.</li> </ul>	<ul style="list-style-type: none"> <li>Apagar el compresor, esperar hasta que el motor esté frío y después revisar el disyuntor de circuito del motor.</li> </ul>
<ul style="list-style-type: none"> <li>Fusible quemado o disyuntor de circuito disparado.</li> </ul>	<ul style="list-style-type: none"> <li>Cambiar el fusible o reactivar el disyuntor de circuito.</li> </ul>
<ul style="list-style-type: none"> <li>Alambre de calibre incorrecto o cordón de extensión de longitud incorrecta.</li> </ul>	<ul style="list-style-type: none"> <li>Comprobar el amperaje del fusible.</li> </ul>
<ul style="list-style-type: none"> <li>La presión del tanque de aire sobrepasa la presión de "activación" del interruptor del motor/presión.</li> </ul>	<ul style="list-style-type: none"> <li>Verificar si hay condiciones de bajo voltaje. Desconectar cualquier otro artefacto eléctrico del circuito o hacer funcionar el compresor de aire en su propio circuito derivado.</li> </ul>
<ul style="list-style-type: none"> <li>La válvula de seguridad en el interruptor del motor/presión no ha descargado la bomba.</li> </ul>	<ul style="list-style-type: none"> <li>Averigüe el calibre correcto del alambre y el largo presión en la de cable adecuado en el cuadro en la página 10.</li> </ul>
<ul style="list-style-type: none"> <li>Defecto en el motor, condensador del motor, interruptor del motor/presión, o válvula de retención.</li> </ul>	<ul style="list-style-type: none"> <li>El motor arrancará automáticamente cuando la presión del tanque de aire disminuye a menos de la presión de "activación" del interruptor del motor/presión. Purgar la conducción, moviendo el interruptor a la posición <b>OFF (0)</b> (apagado). Contactar al departamento de Atención al Cliente de Senco.</li> </ul>

### Síntoma 2. Cuando está en la opción Comenzar/Parar, el motor funciona continuamente.

Causa Probable	Solución
<ul style="list-style-type: none"> <li>El interruptor del motor/presión no apaga el motor cuando el compresor de aire llega a la presión de "desactivación" y la válvula de seguridad se activa.</li> </ul>	<ul style="list-style-type: none"> <li>Mover el interruptor del motor/presión a la posición <b>OFF (0)</b>. Si el motor no se apaga, desenchufar el compresor de aire. Si los contactos eléctricos están soldados juntos, reemplazar el interruptor de presión.</li> </ul>
<ul style="list-style-type: none"> <li>El tamaño del compresor es incorrecto.</li> </ul>	<ul style="list-style-type: none"> <li>Limitar la presión de aire a la capacidad del compresor. Usar ya sea una herramienta más pequeña o un compresor de mayor tamaño.</li> </ul>

### Síntoma 3. El aire continúa escapando por la válvula de seguridad del interruptor del motor /presión después que el motor se para.

Causa Probable	Solución
<ul style="list-style-type: none"> <li>La válvula retención está abierta.</li> </ul>	<ul style="list-style-type: none"> <li>Retirar, limpiar o reemplazar.</li> </ul>

### Síntoma 4. El aire continúa escapando por la válvula de seguridad del interruptor del motor /presión mientras el motor está funcionando.

Causa Probable	Solución
<ul style="list-style-type: none"> <li>Interruptor del motor/presión defectuoso.</li> </ul>	<ul style="list-style-type: none"> <li>Reemplazarlo.</li> </ul>

### Síntoma 5. Escape de aire por la válvula de seguridad.

Causa Probable	Solución
<ul style="list-style-type: none"> <li>Posible válvula de seguridad defectuosa.</li> </ul>	<ul style="list-style-type: none"> <li>Activar manualmente la válvula de seguridad rando del anillo.</li> </ul>
<ul style="list-style-type: none"> <li>Exceso de presión en el tanque de aire.</li> </ul>	<ul style="list-style-type: none"> <li>Si todavía pierde, reemplazarla. Interruptor del motor/presión defectuoso. Reemplazarlo.</li> </ul>

<b>Localización Y Solución De Averías</b>	
<b>Síntoma 6. Fugas de aire en los accesorios.</b>	
<b>Causa Probable</b>	<b>Solución</b>
<ul style="list-style-type: none"> <li>• Los accesorios no están bien apretados.</li> </ul>	<ul style="list-style-type: none"> <li>• Apretarlos donde se escuche escapar el aire. Probar los accesorios con una solución de agua jabonosa. No sobreapretar.</li> </ul>
<b>Síntoma 7. Fuga de aire en el tanque de aire.</b>	
<b>Causa Probable</b>	<b>Solución</b>
<ul style="list-style-type: none"> <li>• Tanque de aire defectuoso u oxidado.</li> </ul>	<ul style="list-style-type: none"> <li>• Se debe reemplazar el tanque de aire. ¡No intentar reparar el tanque de aire! No soldar, reparar o hacer modificaciones.</li> </ul>
<b>Síntoma 8. Sale un chorro de aire por el filtro de admisión.</b>	
<b>Causa Probable</b>	<b>Solución</b>
<ul style="list-style-type: none"> <li>• Válvula (de lámina) de entrada dañada.</li> </ul>	<ul style="list-style-type: none"> <li>• Contactar al departamento de Atención al Cliente SENCO.</li> </ul>
<b>Síntoma 9. Presión insuficiente en el implemento o herramienta neumática.</b>	
<b>Causa Probable</b>	<b>Solución</b>
<ul style="list-style-type: none"> <li>• La perilla del regulador de presión no está en la posición de presión bastante alta o el regulador de presión está defectuoso.</li> </ul>	<ul style="list-style-type: none"> <li>• Ajustar la perilla del regulador de presión a la posición correcta o cambiarla.</li> </ul>
<ul style="list-style-type: none"> <li>• Filtro de admisión de aire obturado.</li> </ul>	<ul style="list-style-type: none"> <li>• Limpiarlo.</li> </ul>
<ul style="list-style-type: none"> <li>• Fugas de aire.</li> </ul>	<ul style="list-style-type: none"> <li>• Ver si hay fugas y repararlas.</li> </ul>
<ul style="list-style-type: none"> <li>• El compresor de aire no es lo bastante grande para el aire requerido.</li> </ul>	<ul style="list-style-type: none"> <li>• Verificar el requerimiento de aire del implemento. Si es mayor que suministro de presión o pulg3/min del compresor de aire, se necesita un compresor de mayor tamaño.</li> </ul>
<b>Síntoma 10. El compresor no produce suficiente aire.</b>	
<b>Causa Probable</b>	<b>Solución</b>
<ul style="list-style-type: none"> <li>• Filtro de admisión de aire obturado.</li> </ul>	<ul style="list-style-type: none"> <li>• Limpiarla.</li> </ul>
<ul style="list-style-type: none"> <li>• Válvula (de láminas) defectuosa.</li> </ul>	<ul style="list-style-type: none"> <li>• Vaciar el tanque de aire y medir el tiempo de bombeo. Comparar con las especificaciones. Si es menor, retirar el cabezal de la bomba e inspeccionar la placa de válvula. Limpiar o reemplazar.</li> </ul>
<b>Síntoma 11. Hay humedad en el aire de descarga.</b>	
<b>Causa Probable</b>	<b>Solución</b>
<ul style="list-style-type: none"> <li>• Condensación en el tanque de aire causada por un alto nivel de humedad atmosférica, o se hace funcionar el compresor de aire lo suficiente.</li> </ul>	<ul style="list-style-type: none"> <li>• Vaciar el tanque de aire después de cada uso. Vaciar el tanque de aire más frecuentemente en climas húmedos y colocar un filtro en el tubo de aire.</li> </ul>

## Especificaciones

Nº de modelo PC 1010		
<b>Motor</b>	Potencia	.5 hp máximo / 0.3 KW
	Voltaje	230V
	Amperaje	2A
	Hz	50 Hz
	Fase	Monofásico
	Rev/min.	2850
<b>Bomba del compresor</b>	Número de cilindros	1
	Etapas de compresión	1
	Cigüeñal	Aluminio
	Cojinetes	De bola
	Cilindro	Aluminio
	Válvulas	De láminas (reed) sencilla
	Cabezal	Aluminio
	Filtro	Inserto
<b>Ajuste del interruptor del motor/presión</b>	Desactivación	8.6 bar (125 PSI)
	Activación	6.6 bar (95 PSI)
	Controles	ON (1) / OFF (0)
<b>Tanque de aire</b>	Capacidad	3.8 Liter(1 Gallon)
	L/Min Desplazamiento de aire	32 (1.1 CFM)
	L/Min @ 2.8 bar	17 (0.6 CFM @ 40 PSI)
	L/Min @ 6.2 bar	10 (0.35 CFM @ 90 PSI)
	L/Min @ 6.9 bar	9 (0.31 CFM @ 100 PSI)
	Presión máxima	8.6 bar (125 PSIG)
	Tiempo de bombeo: 0-9 bar	160 segundos
	Tiempo de recuperación: 7-9 bar	48 segundos
<b>Peso</b>	Neto	9.1 kg
<b>Dimensiones</b>	Básico largo x ancho x alto	36 x 33 x 25 cm
<b>Noise</b>	Measured sound power level (dB)	78 dBA
	Guaranteed sound power level (dB)	81 dBA

## Declaración De Conformidad

Nosotros, Senco Brands, Inc.  
 dirección legal 4270 Ivy Pointe Blvd., Cincinnati, Ohio 45245  
 y de acuerdo con la(s) directiva(s) siguiente(s):  
**Directiva 2006/42/EC sobre máquinas**  
**Pressure Vessel Directive 2009/105/EC.**  
**EMC Directive 2004/108/EC**  
**Low Voltage Directive 2006/95/EC**  
**RoHS Directive 2011/65/EU**  
**Noise Emission Directive 2005/88/EC**  
 declaramos bajo nuestra entera responsabilidad que: Modelo(s):  
**PC 1010 EU, PC 1010EU-2P, PC 1010EUS, PC 1010EUS-UK110,**  
**PC 1010PL, PC 1010S, PC 1010UK1, PC 1010UK2**  
 se ajusta a los requisitos esenciales de salud y seguridad establecidos en los  
 documentos siguientes:  
**EN ISO 14121-1:2007, EN ISO 3744:1995, EN ISO 4871:2009,**  
**EN1012-1:2010, EN 60204-1:2006+A1:2009, EN286-1:1998**  
 Firmada por: Chis Klein  
 Cargo: Director de Ingeniería  
 Procedencia de los documentos: Senco Brands, Inc.  
 4270 Ivy Pointe Blvd., Cincinnati, Ohio 45245  
 Emisión original: 4 de Septiembre 2014  
 Representante autorizado:  
 (autorizado a completar la ficha técnica)  
 Nombre: Peter van der Wel  
 Dirección: Senco Brands B.V.  
 Geurdeland 17E, 6673 DR Andelst, The Netherlands

**1. Senco Professional End User Warranty Policy**

Considering the following constraints Senco underwrites the reliability and the quality of its supplied authorised Senco branded products.

1.1 Senco warrants to the end user that the following products will be free from defects in construction, assembly and material for the warranty period specified below.

Product	Warranty period
Senco ® XP Series-Red Cap, pneumatic tools	Five years
Senco ® XP Series-Black Cap, pneumatic tools	Two years
Senco Pro Series, pneumatic tools	One year
Senco Semi-Pro Series, pneumatic tools	One year
Senco DuraSpin ® Series, electric and battery tools	One year
Senco Cordless battery tools	Two years
Senco batteries and chargers for tools	One year
Senco gas tools	Two years
Senco Reconditioned Products	One year
Senco other tools	One year
Senco Compressors	One year

1.2 The warranty period starts on the day the end user purchases the product and/or 1 year after the tool has been deleted from the product line, which ever date comes first.

1.3 To claim warranty the end user needs to send the defective products or their parts, including the serial number and the original and dated sales receipt or proof of purchase from the original retailer or dealer, freight prepaid to the original retailer or dealer.

1.4 Senco is not obliged to do any repairs or replacements on any products or their parts on site.

1.5 During the warranty period Senco or its distributors will repair or replace defective products or their parts, exclusively or mainly as a result of an imperfection in construction, assembly or material, at Senco's option and expense, subject to the constraints of this warranty policy.

1.6 The repair or replacement of products or their parts under warranty, does in no case lead to prolongation of the warranty period. For every replacement product or part, the remaining original warranty period of the replaced product or part is applicable.

1.7 Senco will become the owner of the products or parts that have been replaced by Senco or its distributors as a result of being compliant to Senco's warranty, without being obligated any compensation in this matter.

1.8 Excluded from the warranty are:

- Normal wear and tear parts, for example rubber o-rings, seals, driver blades, piston stops, piston/driver assemblies, isolators, drive belts, air filters and fuel systems, bits;
- Any imperfection that is a result of or has evolved from the fact that there has not been used clean, dry regulated compressed air and/or the air pressure applied has exceeded the maximum indicated on the tool casting (pneumatic tools);
- Any imperfection that is a result of or has evolved from normal wear, misapplication, abuse/misuse, improper modifications or storage, shipping/transport, accidents, neglect, operation at other than recommended speeds or voltage (electric units only);
- Any imperfection that is a result of or has evolved from explosions, fires and natural disasters, like hurricanes, floods and earthquakes;
- Any imperfection that is a result of or has evolved from not following operating instructions, specifications and / or maintenance schedules. Read the Operator Manual for use, specifications and maintenance instructions;
- Any imperfection that is caused by repairs, modifications to the product or attempts to do so by the end user or any third party;
- Labour charges or loss or damage resulting from improper operation, maintenance or repairs are not covered by this warranty
- Any warranty claims that have been received after the warranty period, as specified in this end user warranty, has expired.

1.9 Additional costs like shipping/transport, special packaging requirements and costs of travel and accommodation, are at the end users expense.

1.10 If a complaint is unfounded, all costs incurred thereby, including handling, inspection, shipping and administrative costs on the side of Senco or its distributors, will be charged to the end user.

1.11 After expiration of the warranty period, all costs for repair or replacement, including handling, inspection, shipping and administrative costs will be charged to the end user.

1.12 Notwithstanding legal limitation periods, the limitation of all claims and appeals against Senco and third parties involved by Senco for the implementation of the agreement is one year.

1.13 If Senco fails to meet this agreement, it will not discharge the end user from the obligations arising under this or any other contract.

1.14 When the warranty terms can not be met, due to for example import or export prohibitions, strikes or other unforeseen circumstances, the warranty period will be extended accordingly.

1.15 Senco's liability is limited to the warranty. Senco is not liable for damage caused by the functioning or non-functioning of the products as delivered, repaired or modified by Senco or its distributors, including but not limited to, production losses, profit losses, reduced working range, commercial losses or consequential damages or indirect damages whatsoever.

## Compresor De Aire Eléctrico

### Parts Reference Guide

NO:RLB-1409

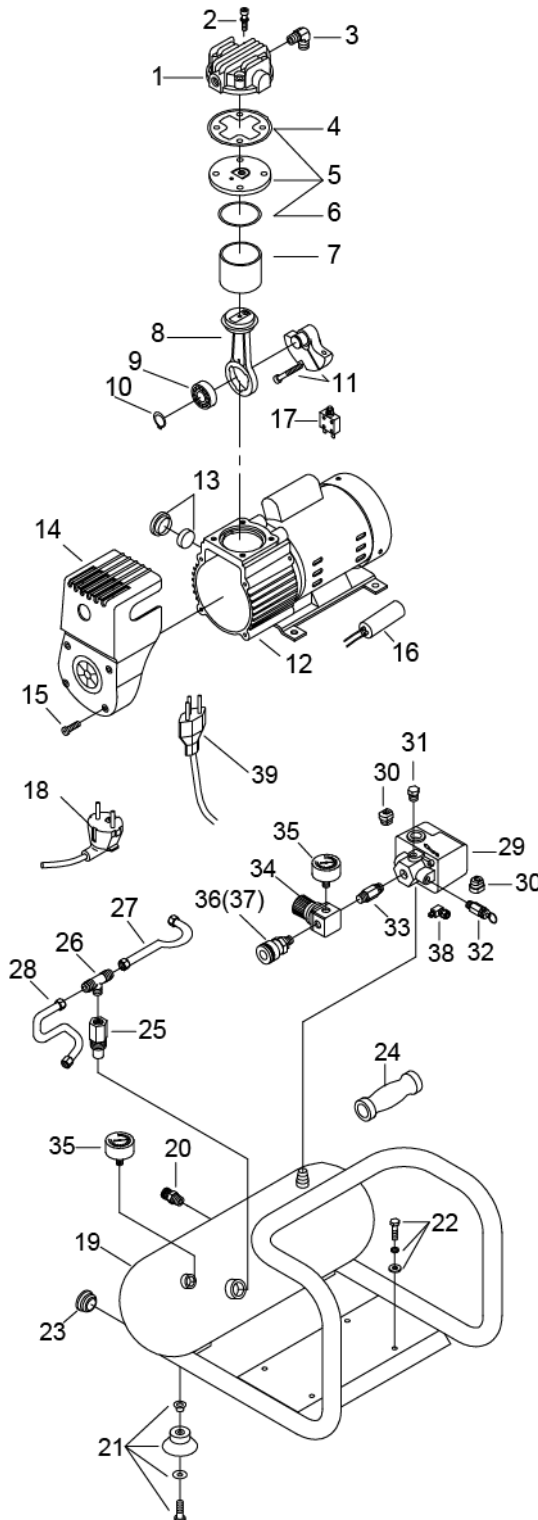

Ref. No.	Description	Part No.	Qty.
1	CYLINDER HEAD	3101063A	1
2	ALLEN BOLT SET	3B01-M05*060V	4
3	EXHAUST ELBOW	2N06-01T02H	1
4	CYLINDER HEAD GASKET	2G01-025H	1
5	EXHAUST VALVE ASSEMBLY	3B11-DC02A	1
6	VALVE SEAT GASKET	2G03-018	1
7	CYLINDER	3201068	1
8	ROD ASSEMBLY	3B3-MB02	1
9	BEARING	2N35-6201ZZC3	1
10	CLIP	2N42-S12	1
11	CRANKSHAFT & BALANCER	3304086	1
12	MOTOR SET	3B8-MB0206S	1
13	AIR FILTER SET	2140026RS	1
14	SHROUD	2428015RS	1
15	BOLT	2B02-FM4*015B	4
16	RUNNING CAPACITOR	2E27-004F4525	1
17	CIRCUIT BREAKER	2E25-01AS	1
18	POWER CABLE (2 PIN)	2E01-029S	1
19	AIR TANK	3401174U	1
20	DRAIN VALVE	2405012	1
21	RUBBER PAD SET	3433011-ARS	4
22	HEXAGON BOLT SET	3B00-FM06*012RS	4
23	PLUG	2N32-W07RS	2
24	GRIP	2432107	1
25	CHECK VALVE	2414033A	1
26	UNLOADING 3-WAY PIPE	2N09-02H01T02H4	1
27	UNLOADING TUBE	3B2-02*190F	1
28	DISCHARGE TUBE	2T02-02*0260RS	1
29	PRESSURE SWITCH	2E21-AA256BPS	1
30	STRAIN RELIEF BUSHING	2E04-008	2
31	PLUG	2N33-009	1
32	PRESSURE RELIEF VALVE	2406021A	1
33	NIPPLE	2N01-058RS	1
34	REGULATOR	2408008RRS	1
35	PRESSURE GAUGE	2D12-15D14BAR	2
36	QUICK COUPLER (FOR PC1010EU ONLY)	07S1/4M-ERS	1
37	QUICK COUPLER (FOR PC1010EU COMBO KIT, PC1010S, 6PR2001N)	07OS1/4M-C	1
38	UNLOADING VALVE	2409015	1
39	POWER CABLE (3 PIN)	2E01-044S	1



# Compressore d'aria elettrico

## Istruzione Per L'Uso

(Traduzione Delle  
Istruzioni Originali)



# SENCO<sup>®</sup>

Senco Brands, Inc.  
4270 Ivy Pointe Blvd.  
Cincinnati, OH 45245  
1-800-543-4596  
www.senco.com  
EMEA: www.senco-emea.com



Questo manuale contiene le norme per un utilizzo corretto e sicuro del vostro compressore.



Leggere attentamente le istruzioni.

PC1010 • Rivisto 11 Marzo 2015 (Sostituisce 1/24/2013)

## Indice

Introduzione .....	3
Controllo .....	3
Misure Di Sicurezza .....	4
Caratteristiche Del Compressore .....	8
Preparazione .....	10
Montaggio Iniziale .....	10
Collocamento .....	10
Sistema Elettrico .....	10
Funzionamento .....	11
Checklist Preliminare .....	11
Messa In Funzione .....	11
Spegnimento .....	11
Manutenzione .....	11
Localizzazione e soluzione delle avarie .....	12
Specifiche .....	14
Dichiarazione Di Conformità .....	14
Garanzia Limitata .....	15
Parts Reference Guide .....	16

## Introduzione

Congratulazioni per l'acquisto di un compressore d'aria SENCO®! Il vostro nuovo compressore d'aria SENCO è stato costruito con i più alti livelli di precisione e accuratezza. Ogni singolo componente è stato scrupolosamente controllato da personale tecnico per garantire al compressore d'aria qualità, affidabilità e durata nel tempo.

Questo manuale utente è stato redatto per vostro beneficio. Leggendo e rispettando le semplici istruzioni di sicurezza, installazione, messa in funzione e manutenzione descritte in questo manuale, godrete di anni di perfetto funzionamento del vostro nuovo compressore d'aria SENCO. Il contenuto di questo manuale è basato sulle informazioni più recenti riguardanti il prodotto commercializzato al momento della pubblicazione. Il produttore si riserva il diritto di modificare senza preavviso e in qualsiasi momento prezzo, colore, materiale, specifiche tecniche o modello.



### Messaggi Di Sicurezza!

I messaggi di sicurezza "PERICOLO, AVVERTENZA o ATTENZIONE" sono contenuti nelle icone "MESSAGGI DI SICUREZZA". Questo riquadro è impiegato per designare ed enfatizzare i messaggi di sicurezza che devono essere rispettati durante l'impiego di questo compressore d'aria. I messaggi di sicurezza sono accompagnati da "parole chiave di avvertenza" che indicano il grado o livello di rischio. Le "parole di avvertenza" che vengono impiegate in questo manuale sono le seguenti:

**Pericolo:** Indica una situazione di imminente pericolo grave che, se non scongiurata PROVOCHERÀ lesioni gravi o morte.

**Avvertenza:** Indica una situazione potenzialmente pericolosa che, se non scongiurata, POTREBBE provocare lesioni gravi o morte.

**Attenzione:** Indica una situazione potenzialmente pericolosa che, se non scongiurata PUO' provocare lesioni lievi o moderate o danni allo strumento.

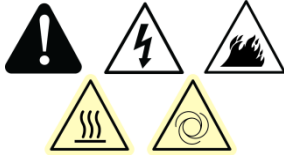

I simboli alla sinistra di questo paragrafo sono i "Segnali di Sicurezza". Queste icone sono utilizzate per richiamare l'attenzione su strumenti o procedure che potrebbero essere pericolose per l'utente e per qualunque altra persona stia utilizzando lo strumento.

**FORNIRE SEMPRE UNA COPIA DI QUESTO MANUALE A CHIUNQUE UTILIZZI LO STRUMENTO. PRIMA DI METTERE IN FUNZIONE IL COMPRESSORE D'ARIA LEGGERE TUTTE LE ISTRUZIONI CONTENUTE IN QUESTO MANUALE E QUELLE FORNITE DAL PRODUTTORE PER GLI ACCESSORI, PRESTANDO PARTICOLARE ATTENZIONE ALLE "NORME DI SICUREZZA" PER PREVENIRE LESIONI PER L'OPERATORE.**

## Controllo

Disimballare il compressore d'aria e annotare il numero di serie dello strumento nello spazio appositamente preposto. Verificare che durante il trasporto non si siano verificati danni visibili o presunti. Prima di mettere in funzione il compressore d'aria, assicurarsi di aver sostituito tutti i componenti danneggiati e di aver riparato i meccanismi.

### NUMERO DI SERIE

---

Per assistenza o commenti chiamare la linea verde SENCO: **1-800-543-4596** o inviare una e-mail: [toolprof@Senco.com](mailto:toolprof@Senco.com)

Prima di chiamare è necessario avere a portata di mano le seguenti informazioni:



1. Numero del modello
2. Numero di serie
3. Data e luogo di acquisto

Senco, 4270 Ivy Pointe Blvd., Cincinnati, OH 45245

## Misure Di Sicurezza





### Leggere Tutte Le Misure Di Sicurezza Prima Di Utilizzare Il Compressore D'Aria

Rischio	Conseguenze Potenziali	Prevenzione
<p><b>Pericolo Di Elettroshock O Elettrocuzione</b></p>  	<ul style="list-style-type: none"> <li>Se il compressore d'aria non è correttamente connesso a terra, potrebbero verificarsi lesioni gravi e morte. Il compressore d'aria è alimentato da elettricità e può provocare elettroshock o elettrocuzione qualora non venga usato propriamente.</li> </ul>	<ul style="list-style-type: none"> <li>Assicurarsi che il connettore d'aria sia collegato a una presa per la corrente perfettamente connessa a terra e che il voltaggio fornito sia corretto e i fusibili di protezione adeguati.</li> </ul>
	<ul style="list-style-type: none"> <li>Il cavo elettrico può causare elettroshock.</li> </ul>	<ul style="list-style-type: none"> <li>Verificare il buono stato del cavo di alimentazione e controllare che non siano presenti segni di danneggiamento da calore. Qualora il cavo sia difettoso, sostituirlo prima di usare il compressore.</li> <li>Mantenere asciutte e sospese da terratutte le connessioni. Evitare di lasciare le connessioni nelle immediate vicinanze di acqua, non toccare la presa della corrente con mani bagnate.</li> <li>Per staccare il cavo elettrico dalla presa, evitare di tirarlo.</li> </ul>
	<ul style="list-style-type: none"> <li>Se il compressore d'aria non viene maneggiato in modo corretto può provocare elettroshock.</li> </ul>	<ul style="list-style-type: none"> <li>Non toccare il compressore quando bagnato e non utilizzare con pioggia. Evitare l'impiego del compressore con protezioni dello stesso danneggiate o rimosse.</li> </ul>
	<ul style="list-style-type: none"> <li>Pericolo di lesioni gravi o morte se le riparazioni elettriche vengono effettuate da personale non qualificato.</li> </ul>	<ul style="list-style-type: none"> <li>Ogni tipo di connessione o riparazione elettrica deve essere effettuata esclusivamente da personale autorizzato conforme alle normative elettriche nazionali e locavigenti.</li> <li>Prima di aprire la scatola delle connessioni elettriche, assicurarsi che il compressore sia spento, scaricare la pressione e staccare direttamente dalla spina il cavo di alimentazione dello strumento. Lasciare raffreddare il compressore d'aria. Non lavorare mai sul compressore spento senza rispettarle norme di sicurezza, anche se lo strumento in quel momento non è in funzione, potrebbe accendersi in un qualsiasi momento!</li> </ul>

## Misure Di Sicurezza



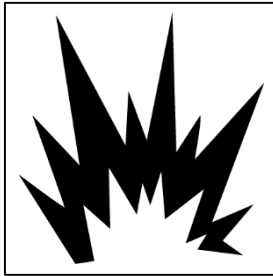

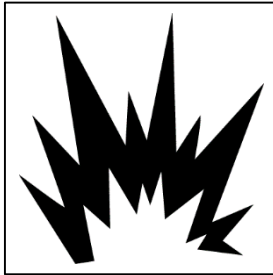

### Leggere Tutte Le Misure Di Sicurezza Prima Di Utilizzare Il Compressore D'Aria

Rischio	Conseguenze Potenziali	Prevenzione
<p><b>Pericolo Di Eslosione O Incendio</b></p>  	<ul style="list-style-type: none"> <li>Le scintille elettriche che normalmente si verificano nel motore e nell'interruttore di pressione possono causare lesioni gravi o morte.</li> </ul>	<ul style="list-style-type: none"> <li>Utilizzare sempre il compressore in un luogo ben ventilato e lontano da vapori infiammabili, polvere combustibile, gas e altri materiali suscettibili di combustione.</li> <li>Se si sta spruzzando materiale infiammabile tenere il compressore d'aria ad almeno 6 metri di distanza dalla zona di intervento. (Necessario probabilmente un naspo aggiuntivo).</li> </ul>
	<ul style="list-style-type: none"> <li>Possono verificarsi lesioni gravi se una qualunque delle bocchette di ventilazione del compressore si ottura causando il surriscaldamento dello strumento e l'incendio dello stesso.</li> </ul>	<ul style="list-style-type: none"> <li>Non collocare oggetti contro o sopra il compressore d'aria. Utilizzare il compressore d'aria ad almeno 30cm di distanza dalla parete o dall'eventuale ostacolo che potrebbe limitare la ventilazione adeguata.</li> </ul>
<p><b>Pericolo Di Scoppio</b></p> 	<ul style="list-style-type: none"> <li>Pericolo di lesioni gravi o morte derivanti da esplosione del serbatoio dell'aria se la manutenzione è insufficiente.</li> </ul>	<ul style="list-style-type: none"> <li>Svuotare quotidianamente il serbatoio dell'aria o comunque dopo ogni utilizzo per evitare l'accumularsi dell'umidità nel serbatoio.</li> <li>Qualora il serbatoio perdesse aria, sostituirlo immediatamente. Non apportare modifiche nè saldature al serbatoio o ai suoi accessori.</li> <li>Non modificare i settaggi di pressione impostati dal produttore.</li> </ul>
	<ul style="list-style-type: none"> <li>Pericolo di lesioni gravi causate da avaria del compressore d'aria o dall'esplosione degli accessori per uso di componenti, parti di ricambio ecc. non adeguati.</li> </ul>	<ul style="list-style-type: none"> <li>Non superare la capacità massima ammissibile dichiarata dal produttore per gli accessori.</li> <li>Per il tubo di scarico, non impiegare tubi in plastica o giunti saldati a stagno a causa del grande calore.</li> <li>L'uso del compressore d'aria per il gonfiaggio di piccoli oggetti quali giocattoli non è consigliato.</li> <li>Tutti i tubi flessibili e montaggi saranno adatti ad uso del luogo alla pressione di esercizio massima permessa del compressore portatile.</li> <li>Utilizzare solo ricambi originali SENCO per il vostro compressore d'aria.</li> </ul>

## Misure Di Sicurezza

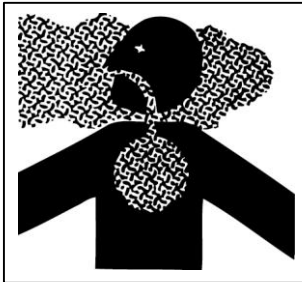



### Leggere Tutte Le Misure Di Sicurezza Prima Di Utilizzare Il Compressore D'Aria

Rischio	Conseguenze Potenziali	Prevenzione
<p><b>Pericolo Per Le Vie Respiratorie</b></p> 	<ul style="list-style-type: none"> <li>• Lesioni gravi o morte potrebbero verificarsi inalando l'aria compressa. Il flusso d'aria può contenere monossido di carbonio, vapori tossici e particelle solide.</li> <li>• le sostanze spruzzate come vernici, solventi, sverniciatori, insetticidi ed antimuffe, contengono vapori nocivi e velenosi.</li> </ul>	<ul style="list-style-type: none"> <li>• Non inalare né direttamente neppure attraverso un respiratore collegato al compressore l'aria compressa dello strumento.</li> <li>• Utilizzare il compressore solo in luogo ben ventilato. Seguire le norme di sicurezza fornite con le sostanze spruzzate. Con alcune sostanze è necessario l'impiego di una mascherina.</li> </ul>
<p><b>Pericolo Di Ustioni</b></p> 	<ul style="list-style-type: none"> <li>• Pericolo di lesioni gravi se vengono toccate le parti metalliche scoperte. Queste parti metalliche possono rimanere calde per lungo tempo anche a strumento ormai spento.</li> </ul>	<ul style="list-style-type: none"> <li>• Evitare che parti del corpo o altri materiali entrino in contatto con le parti metalliche scoperte del compressore d'aria, motore o tubazioni.</li> </ul>
<p><b>Pericolo Di Essere Colpiti Da Oggetti Volanti</b></p> 	<ul style="list-style-type: none"> <li>• Il flusso di aria compressa può danneggiare i tessuti blandi.</li> </ul>	<ul style="list-style-type: none"> <li>• Utilizzare sempre occhiali di sicurezza modello OSHA "Z87" per proteggersi dagli eventuali residui volanti.</li> <li>• Non direzionare il flusso d'aria verso se stessi, altre persone o animali.</li> <li>• Non lasciare mai incustodito il compressore d'aria. Prima di effettuare interventi di manutenzione/connessione di accessori, ecc, ricordarsi sempre di spegnere il compressore d'aria e di scaricare la pressione.</li> </ul>
<p><b>Indossare Sempre Occhiali Protettivi</b></p> 	<ul style="list-style-type: none"> <li>• Lesioni gravi potrebbero verificarsi a causa di residui scolti lanciati a grande velocità dal getto d'aria compressa.</li> </ul>	<ul style="list-style-type: none"> <li>• Mantenere sempre una distanza di sicurezza tra il compressore e le persone o gli animali.</li> <li>• Non muovere il compressore d'aria mentre il serbatoio è ancora pressurizzato. Non cercare di muovere il compressore tirandolo dal nastro.</li> </ul>

## Misure Di Sicurezza



Leggere Tutte Le Misure Di Sicurezza Prima Di Utilizzare Il  
Compressore D'Aria

Rischio	Conseguenze Potenziali	Prevenzione
<p><b>Pericolo Di Essere Colpiti Da Parti In Movimento</b></p>  <p><b>Attenzione: La Macchina Potrebbe Partire Senza Preavviso</b></p> 	<ul style="list-style-type: none"> <li>Rischio di lesioni provocate da parti in movimento. Questo compressore d'aria funziona in automatico quando l'interruttore della pressione è in posizione <b>ON (1)</b>/Auto (acceso/automatico).</li> <li>Rischio di lesioni causate dall'uso negligente.</li> </ul>	<ul style="list-style-type: none"> <li>Spegnere sempre il compressore d'aria se non in uso. Prima di effettuare interventi di manutenzione spurgare la valvola di pressione e staccare il cavo elettrico dalla presa. Tutte le riparazioni del compressore devono essere effettuate da personale tecnico autorizzato. Non lavorare mai sul compressore spento senza rispettare le norme di sicurezza, anche se lo strumento in quel momento non è in funzione, potrebbe accendersi in un qualsiasi momento!</li> <li>Non utilizzare il compressore se le protezioni e i rivestimenti non sono presenti. Provvedere alla sostituzione di questi prima dell'utilizzo.</li> </ul>
<p><b>Pericolo Da Negligenza</b></p> 		<ul style="list-style-type: none"> <li>Tenere il compressore d'aria lontano dalla portata di bambini ed adolescenti.</li> <li>Fare sempre attenzione a quello che si sta facendo.</li> <li>Non utilizzare in situazioni di stanchezza, sotto effetto di alcool o droghe.</li> <li>Sapere cosa fare per spegnere lo strumento, essere informati delle verifiche necessarie da effettuare al compressore.</li> </ul>
<p><b>Rischio Di Danno Al Compressore</b></p>	<ul style="list-style-type: none"> <li>Pericolo di dover apportare riparazioni urgenti.</li> </ul>	<ul style="list-style-type: none"> <li>Non utilizzare il compressore senza filtro d'aria.</li> <li>Non utilizzare in un ambiente con sostanze corrosive.</li> <li>Sistemare il compressore d'aria in posizione stabile e sicura per evitare che questo cada mentre in funzione.</li> <li>Seguire tutte le norme di manutenzione presentate in questo manuale.</li> </ul>

**! TENERE QUESTE ISTRUZIONI SEMPRE A PORTATA DI MANO !**

## Caratteristiche Del Compressore

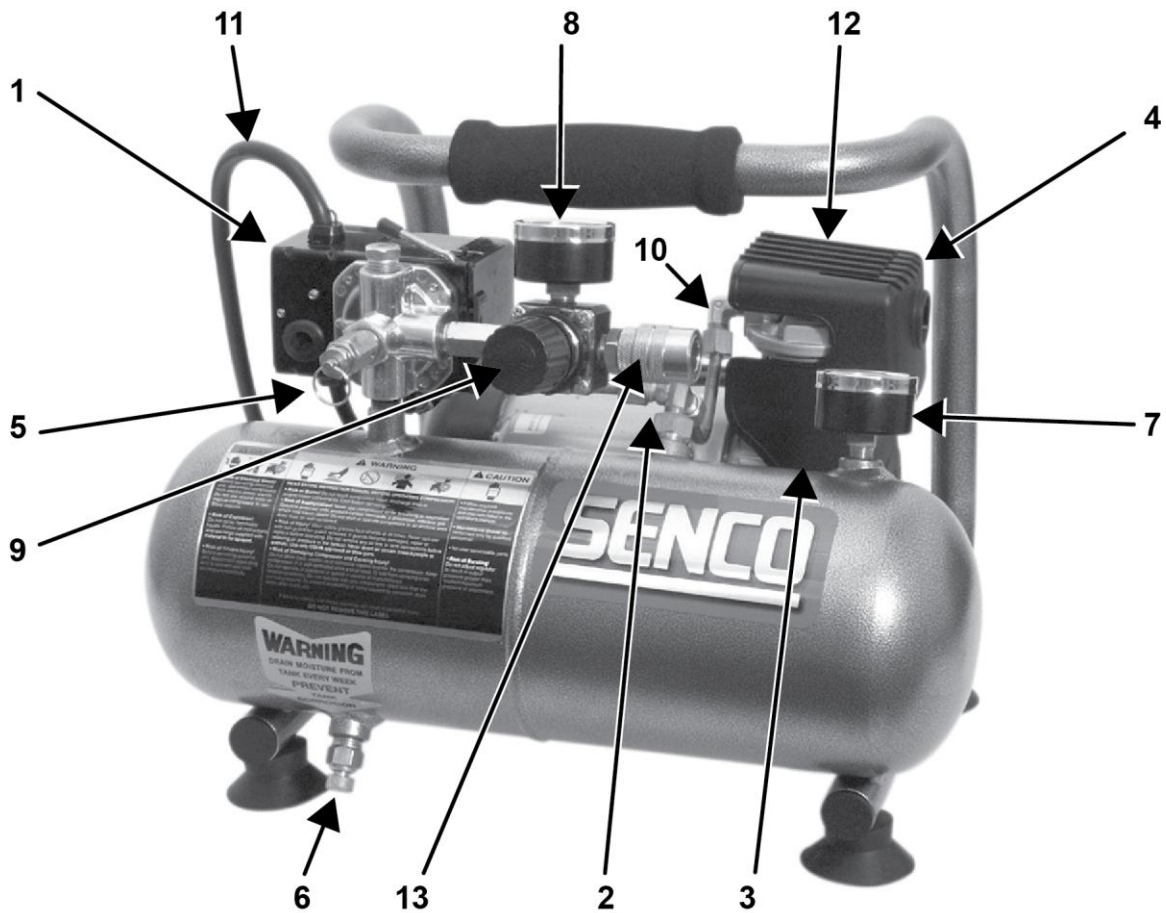

1.	Interruttore di motore/pressione
2.	Ventola/Riposizionamento
3.	Filtro di ingresso aria
4.	Pompa del compressore
5.	Valvola di sicurezza
6.	Valvola di spurgo del serbatoio d'aria
7.	Manometro del serbatoio
8.	Manometro di pressione di uscita
9.	Regolatore di pressione
10.	Tubo di scarico
11.	Cavo di alimentazione a 230 volts
12.	Bocchette di ventilazione/coperture protettive
13.	Disconnessione veloce



## Caratteristiche Del Compressore

**1) Interruttore Di Motore/Pressione:** Questo interruttore serve per azionare o spegnere il compressore d'aria. Mettendolo in posizione **ON (1)** (acceso) si fornirà alimentazione automatica all'interruttore di pressione che azionerà il motore quando la pressione sarà adeguata, ovvero più bassa della pressione di accensione selezionata dal produttore. Quando si colloca in posizione **ON (1)** (accensione/arresto), l'interruttore di pressione spegne il motore quando la pressione del serbatoio arriva al punto di "disattivazione" impostata dal produttore. Per misure di sicurezza, questo interruttore dispone di una valvola di sicurezza di pressione ubicata sul lato dell'interruttore, in modo da scaricare automaticamente l'aria compressa dalla pompa del compressore e dal tubo di spurgo in caso il compressore arrivi alla situazione di "disattivazione" o nel caso in cui il motore si spenga. In questo modo il motore può mettersi nuovamente in funzione. Selezionando la posizione **OFF (0)** (spento) si spegne il compressore d'aria.

**2) Sovraccarico Del Motore:** Il motore ha un interruttore di protezione situato sulla pompa. L'interruttore scatterà nel caso di un eccessivo consumo di corrente per proteggere il motore e l'operatore. Ripristinare l'interruttore spingendo lo stelo in plastica nera all'interno dell'alloggiamento. Ripristinare l'interruttore se è scattato.

**3) Filtro Di Ingresso D'Aria:** Il filtro è stato progettato per pulire l'aria che entra nella pompa. Per fare in modo che l'aria in ingresso sia sempre secca, fresca e pulita, è necessario che il filtro sia sempre pulito e le bocchette di ventilazione libere da ostruzioni. Per pulire il filtro, rimuoverlo e pulirlo con acqua tiepida insaponata. Risciacquare e lasciare asciugare.

**4) Pompa Del Compressore D'Aria:** Per comprimere l'aria, il pistone si muove in senso verticali nel cilindro. Nella corsa discendente, la valvola di ingresso aspira l'aria dall'esterno e la valvola di uscita rimane chiusa. Nella corsa ascendente, l'aria si comprime, la valvola di ingresso si chiude e l'aria compressa è spinta verso l'esterno attraverso la valvola di uscita prima, il tubo di scarico, la valvola di ritenzione e quindi all'interno del serbatoio dell'aria.

**5) Valvola Di Sicurezza:** Questa valvola è disegnata per evitare falle del sistema, scaricando la pressione del sistema quando l'aria compressa raggiunge un livello predeterminato. Questa valvola è impostata direttamente dal produttore e non deve essere modificata. Per verificare il suo corretto funzionamento, tirare l'anello, dovrebbe uscire pressione. Rilasciando l'anello, i parametri vengono ristabiliti.

**6) Valvola Di Spurgo:** Questa valvola serve per spurgare l'umidità del serbatoio d'aria quando il compressore si spegne. **NON cercare di aprire la valvola di spurgo con pressione superiore ai 0.7 bar!** Per aprire la valvola di spurgo girare la manopola in senso antiorario; inclinare il serbatoio per assicurarsi che tutta la condensa si svuoti attraverso la valvola.

**7) Manometro Del Serbatoio D'Aria:** Questo manometro indica la pressione d'aria all'interno del serbatoio. (o dei serbatoi).

**8) Manometro Di Pressione Di Uscita:** Questo manometro indica la pressione d'aria disponibile al lato del regolatore. Questa pressione viene controllata dal regolatore ed è sempre minore o uguale alla pressione del serbatoio.

**9) Regolatore Di Pressione:** La pressione d'aria nel serbatoio è controllata dal regolatore. Girare la manopola in senso antiorario per aumentare la pressione di scarico e, in senso opposto per diminuirla. Seguire le istruzioni di funzionamento dello strumento per la portata di pressione consigliata.

**10) Tubo Di Scarico:** Ricordare che il tubo di scarico è ad alta temperatura. **Superfici Calde - Non rimuovere la copertura protettiva. La temperatura risulta molto alta dopo un utilizzo intenso.**

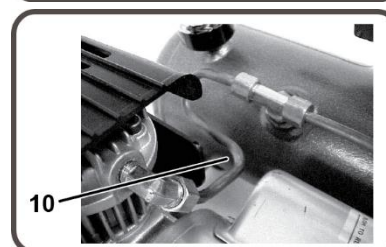
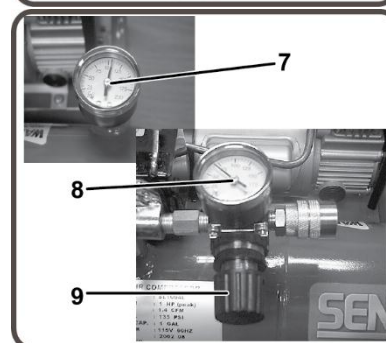
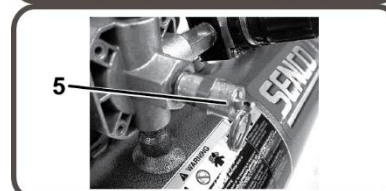
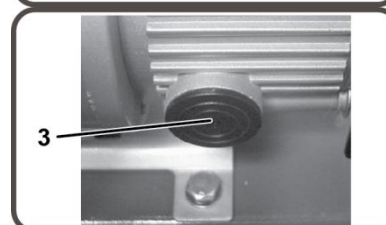
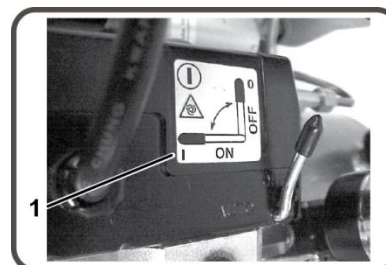

## Preparazione

### Montaggio Iniziale

1. Leggere attentamente le norme di sicurezza prima di procedere al montaggio del compressore d'aria.

### Collocamento

**Attenzione** Per evitare di danneggiare il compressore d'aria, non inclinarlo più di 10°, in senso trasversale o longitudinale.

1. Collocare il compressore d'aria a una distanza di almeno 30cm dagli ostacoli che potrebbero impedirne una ventilazione adeguata.

Non collocare il compressore d'aria in un luogo:

- Dove ci sono segni di fuoriuscita di olio o gas.
- Dove potrebbero essere presenti materiali o vapori infiammabili.

### Avvertenza



Pericolo di gravi lesioni o morte se le scintille dell' interruttore del motore e di pressione entrano in contatto con vapori infiammabili, polvere combustibile, gas o altri materiali combustibili. Quando il compressore è impiegato per pitturare, con una pistola, collocarlo sempre distante dalla superficie di lavoro, utilizzando naspi aggiuntivi per la ventilazione al posto di prolunghe elettriche.

- Dove la temperatura ambientale è inferiore a 0C o superiore ai 40C.
- Dove acqua o aria eventualmente fornita al compressore potrebbe essere eccessivamente sporca.

### Sistema Elettrico

### Pericolo



Una connessione sbagliata strumento-connessione a terra può causare elettroshock o elettrocuzione. In caso di dubbi sull'esattezza della connessione a terra, consultare un elettricista o un tecnico affidabile. Non impiegare alcun tipo di adattatore con questo prodotto. Nel caso sia necessaria la riparazione o la sostituzione del cavo o della presa, non collegare il cavo di messa a terra con nessuna estremità piatta. Il cavo con isolamento di superficie di colore verde, con o senza righe gialle, è il cavo di messa a terra.

### Avvertenza



Il prodotto deve essere connesso a terra. In caso di malfunzionamento o danno, la connessione a terra riduce il rischio di elettroshock. Questo prodotto è fornito di un cavo con un conduttore di connessione a terra dell'apparecchiatura e ha una presa tipo di connessione a terra. La presa con la connessione a terra deve essere inserita ad un interruttore correttamente installato e connesso a terra, secondo tutti i codici e le ordinanze a rispetto.

1. SENCO® NON CONSIGLIA L'USO DI PROLUNGHE, in quanto si può verificare perdita di potenza e surriscaldamento del motore. Si raccomanda l'uso di un naspo di aria aggiuntivo. Se l'uso della prolunga è inevitabile, deve essere connesso ad un interruttore azionato da corrente di scarico a terra (GFCI) protetto adeguatamente da scatole o altre protezioni.

Quando viene impiegata una prolunga:

<u>Lunghezza del cavo</u>	<u>Calibro del cavo</u>
Fino a 7,5m	12 AWG
Fino a 30m	10 AWG
Fino a 50m	8 AWG
Fino a 75m	6 AWG

Impiegare soltanto cavi di prolunga con capacità elettrica non inferiore alla capacità nominale del prodotto. Non utilizzare cavi danneggiati. Esaminare il cavo di prolunga prima di usarlo e cambiarlo in caso di danneggiamento. Non maltrattare il cavo di prolunga e non tirare per scollegarlo dalla presa. Tenere il cavo lontano dalle fonti di calore e dagli angoli. Spegnerne sempre l'interruttore del compressore d'aria prima di staccare la presa dall'interruttore.

## Funzionamento

### Checklist Preliminare

1. Rimuovere l'umidità all'interno del serbatoio del compressore. Scaricare la pressione in eccesso e aprire la valvola di spurgo ubicata nella parte inferiore del serbatoio. Rimuovere la pressione eccessiva tirando l'anello della valvola di sicurezza o con uno strumento d'aria, quindi aprire la valvola di scarico nel fondo del serbatoio d'aria. Chiudere energicamente.



**Avvertenza:** Rischio di lesioni corporali. **NON** cercare mai di aprire la valvola di spurgo quando al pression nel serbatoio è superiore ai 0.7 bar!

2. Assicurarsi che l'interruttore del motore del compressore sia in posizione **OFF (0)**.
3. Assicurarsi che tutte le valvole di sicurezza siano in funzione.
4. Assicurarsi che tutte le protezioni e i rivestimenti siano in correttamente posizionati e saldamente installati.

### Messa In Funzione

1. Assicurarsi che la leva dell'interruttore sulla scatola di pressione sia in posizione **OFF (0)**.
2. Inserire il cavo di alimentazione in una presa con la messa a terra.
3. Spostare la leva dell'interruttore sulla scatola di pressione in posizione **ON (1)**.
4. Con questa operazione, il compressore d'aria si **Avviera** per aumentare la pressione nei serbatoi d'aria e si **Ferma** una volta raggiunta la pressione corretta. Con il diminuire della pressione dovuto all'uso, il compressore **Caricherà** pressione nuovamente.
5. Impostare la pressione muovendo il regolatore della manopola di pressione in senso antiorario per ridurre la pressione e in senso orario per aumentarla.
6. Se si verificano rumori o vibrazioni strane, spegnere il compressore d'aria e consultare la sezione relativa alla "Localizzazione e soluzione delle avarie."

### Spegnimento

1. Per spegnere il compressore d'aria muovere la leva dell'interruttore di pressione in posizione **OFF (0)**. Non spegnere MAI il compressore staccando la spina. Serio rischio di elettrocuzione.
2. Spurgare l'aria dal serbatoio utilizzando la chiave pneumatica connessa allo strumento oppure tirando l'anello della valvola di sicurezza.
3. Quando la pressione all'interno del serbatoio indica meno di 0.7 bar, aprire la valvola di uscita situata sotto ogni serbatoio per far fuoriuscire l'umidità.
4. Lasciare raffreddare il compressore.
5. Pulire il compressore con un panno e riporlo in un luogo sicuro non esposto a fenomeni di congelamento.

## Manutenzione

Leggere il manuale d'uso prima di effettuare lavori di manutenzione. Le procedure indicate devono effettuarsi solo a compressore spento e per lavori di manutenzione.

1. Spegnere il compressore d'aria.



**Avvertenza:** Anche se il compressore non è in funzione, usare la massima cautela in quanto potrebbe rimettersi in moto in qualsiasi momento!

2. Staccare il cavo di alimentazione.
3. Aprire tutte le valvole di spurgo.
4. Aspettare che il compressore si raffreddi prima di iniziare la manutenzione.

Quadro Delle Operazioni Di Manutenzione			
Interventi	Giornalieri	Settimanali	Mensili
Svuotare la condensa dal serbatoio (dai serbatoi) dell'aria	X		
Revisionare in caso di rumore o vibrazioni strane	X		
Revisionare che non ci siano fughe d'aria	X		
Ispezionare il filtro dell'aria		X	
Pulire esternamente il compressore		X	
Revisionare la valvola di sicurezza			X

<b>Localizzazione e soluzione delle avarie</b>	
<b>Sintomo 1. Il motore non funziona e non riparte.</b>	
<b>Causa Probabile</b>	<b>Soluzione</b>
• Il cavo di alimentazione non è connesso.	• Inserire il cavo nella presa con la messa a terra.
• L'interruttore di motore/pressione è in posizione <b>OFF (0)</b> (spento).	• Mettere l'interruttore in posizione <b>ON (1)</b> (accesso).
• E' scattato l'interruttore di surriscaldamento.	• Spegnerne il compressore e attendere il raffreddamento del motore e verificare il disgiuntore di circuito del motore.
• Fusibile bruciato o disgiuntore scattato.	• Sostituire il fusibile o riattivare il disgiuntore di circuito. Provare l'ampereaggio del fusibile. Verificare se esistono situazioni di basso voltaggio. Scollegare tutti gli altri artefatti elettrici dal circuito o far funzionare il compressore d'aria nel suo circuito di derivazione.
• Filo metallico non corretto o cavo di prolunga non adatto.	• Verificare il calibro corretto del filo e la lunghezza del cavo a pagina 10.
• La pressione del serbatoio sorpassa la pressione di "attivazione" dell'interruttore di motore/pressione.	• Il motore si azionerà automaticamente quando la pressione del serbatoio diminuisce ad un livello più basso della pressione di "attivazione" dell'interruttore di motore/pressione.
• La valvola di sicurezza nell'interruttore di motore/pressione non ha scaricato la pressione nella pompa.	• Purgare la conduzione muovendo l'interruttore in posizione <b>OFF (0)</b> (spento).
• Difetto nel motore, nel condensatore del motore, nell'interruttore del motore/pressione o nella valvola di ritenzione.	• Contattare il servizio clienti SENCO.
<b>Sintomo 2. In posizione AVVIO/ARRESTO il motore continua a funzionare.</b>	
<b>Causa Probabile</b>	<b>Soluzione</b>
• L'interruttore del motore/pressione non spegne il motore quando il compressore d'aria arriva alla pressione di "arresto" e la valvola di sicurezza si attiva.	• Mettere l'interruttore di motore/pressione in posizione <b>OFF (0)</b> . se il motore non si spegne, staccare dalla presa il compressore d'aria. Se i contatti elettrici sono saldati insieme, sostituire l'interruttore di pressione.
• La dimensione del compressore non è corretta.	• Limitare la pressione d'aria alla capacità del compressore. Usare uno strumento di dimensioni adeguate.
<b>Sintomo 3. L'aria continua a fuoriuscire dalla valvola di sicurezza dell'interruttore di motore/pressione dopo che il motore si è fermato.</b>	
<b>Causa Probabile</b>	<b>Soluzione</b>
• La valvola di ritenzione è aperta.	• Rimuovere, pulire o sostituire.
<b>Sintomo 4. L'aria continua a fuoriuscire dalla valvola di sicurezza dell'interruttore del motore/pressione mentre il motore è in funzione.</b>	
<b>Causa Probabile</b>	<b>Soluzione</b>
• Interruttore del motore/pressione difettoso.	• Sostituirlo.
<b>Sintomo 5. perdita d'aria dalla valvola di sicurezza.</b>	
<b>Causa Probabile</b>	<b>Soluzione</b>
• Possibile valvola di sicurezza difettosa.	• Attivare la valvola di sicurezza tirando l'anello. Se perde ancora, sostituirla.
• Pressione eccessiva nel serbatoio.	• Interruttore del motore/pressione difettoso. Sostituirlo.

<b>Localizzazione e soluzione delle avarie</b>	
<b>Sintomo 6. Fughe di aria dagli accessori.</b>	
<b>Causa Probabile</b>	<b>Soluzione</b>
<ul style="list-style-type: none"> <li>• Gli accessori non sono ben chiusi.</li> </ul>	<ul style="list-style-type: none"> <li>• Stringere meglio i punti in cui fuoriesce l'aria. Controllare con soluzione di acqua e sapone. Non stringere eccessivamente.</li> </ul>
<b>Sintomo 7. Fuga d'aria dal serbatoio d'aria.</b>	
<b>Causa Probabile</b>	<b>Soluzione</b>
<ul style="list-style-type: none"> <li>• Serbatoio d'aria difettoso o ossidato.</li> </ul>	<ul style="list-style-type: none"> <li>• Il serbatoio deve essere sostituito. Non cercare di ripararlo! Non saldare, riparare od apportare modifiche.</li> </ul>
<b>Sintomo 8. Spiffero dal filtro di ingresso.</b>	
<b>Causa Probabile</b>	<b>Soluzione</b>
<ul style="list-style-type: none"> <li>• Valvola (di lamina) di ingresso danneggiata.</li> </ul>	<ul style="list-style-type: none"> <li>• Contattare il servizio clienti SENCO.</li> </ul>
<b>Sintomo 9. Pressione insufficiente nella pompa pneumatica o nell'accessorio.</b>	
<b>Causa Probabile</b>	<b>Soluzione</b>
<ul style="list-style-type: none"> <li>• La valvola del regolatore di pressione non è in posizione di pressione sufficiente o il regolatore di pressione è difettoso.</li> </ul>	<ul style="list-style-type: none"> <li>• Aggiustare la vite del regolatore di pressione in posizione corretta o sostituirla.</li> </ul>
<ul style="list-style-type: none"> <li>• Filtro di ingresso aria otturato.</li> </ul>	<ul style="list-style-type: none"> <li>• Pulirlo.</li> </ul>
<ul style="list-style-type: none"> <li>• Perdite d'aria.</li> </ul>	<ul style="list-style-type: none"> <li>• Verificare le possibili perdite e ripararle.</li> </ul>
<ul style="list-style-type: none"> <li>• Il compressore d'aria non è abbastanza grande per la quantità d'aria richiesta.</li> </ul>	<ul style="list-style-type: none"> <li>• Controllare la richiesta d'aria dell'accessorio. Se è maggiore dei CFM o della pressione fornita dal compressore, è necessario un compressore d'aria più potente.</li> </ul>
<b>Sintomo 10. Il compressore non produce aria a sufficienza.</b>	
<b>Causa Probabile</b>	<b>Soluzione</b>
<ul style="list-style-type: none"> <li>• Filtro di ingresso otturato.</li> </ul>	<ul style="list-style-type: none"> <li>• Pulirlo.</li> </ul>
<ul style="list-style-type: none"> <li>• Valvola (di lamine) difettosa.</li> </ul>	<ul style="list-style-type: none"> <li>• Svuotare il serbatoio d'aria e verificare con le specifiche il tempo impiegato per il pompaggio. Se il tempo impegnato è minore, rimuovere la testa della pompa e controllare la valvola, pulirla o sostituirla.</li> </ul>
<b>Sintomo 11. Umidità nell'aria di scarico.</b>	
<b>Causa Probabile</b>	<b>Soluzione</b>
<ul style="list-style-type: none"> <li>• Condensa nel serbatoio causata da alto livello di umidità nell'atmosfera o dal fatto che il compressore non funziona abbastanza a lungo.</li> </ul>	<ul style="list-style-type: none"> <li>• Svuotare il serbatoio dopo ogni uso. Svuotare il serbatoio con frequenza qualora il clima sia umido e posizionare un filtro nel tubo dell'aria.</li> </ul>

## Specifiche

N° del modello: PC 1010EU		
<b>Motore</b>	Potenza	0,5 CV / 0,3 KW
	Voltaggio	230V
	Amperaggio	2A
	Frequenza	50 Hz
	Fase	Monofase
	N° giri	2850
<b>Compressore</b>	Numero di cilindri	1
	Fase di compressione	1
	Basamento	In alluminio
	Cuscinetti	A sfera
	Cilindro	In alluminio
	Valvole	A lamina singola
	Testa	In alluminio
	Filtro	Compreso
<b>Livelli di pressione regolati da interruttore automatico</b>	Massima	8.6 bar (125 PSI)
	Minima	6.6 bar (95 PSI)
	Interruttori	ON (1) / OFF (0)
<b>Serbatoio d'aria</b>	Capacità	3.8 Liter(1 Gallon)
<b>Prestazioni</b>	L/Min Aria Dislocamento	32 (1.1 CFM)
	L/Min @ 2.8 bar	17 (0.6 CFM @ 40 PSI)
	L/Min @ 6.2 bar	10 (0.35 CFM @ 90 PSI)
	L/Min @ 6.9 bar	9 (0.3 CFM @ 100 PSI)
	Pressione massima	8.6 bar (125 PSIG)
	Tempo di compressione: 0-9 bar	160 secondi
	Tempo di di recupero: 7-9 bar	48 secondi
<b>Peso</b>	Netto	9.1 kg
<b>Dimensioni</b>	Lunghezza x profondità x altezza	36 x 33 x 25 cm
<b>Rumorosità</b>	Measured sound power level (dB)	78 dBA
	Guaranteed sound power level (dB)	81 dBA

## Dichiarazione Di Conformità

La società Senco Brands, Inc.  
 indirizzo 4270 Ivy Pointe Blvd., Cincinnati, Ohio 45245  
 conformemente alle seguenti direttive:  
**Direttiva macchine 2006/42/CE**  
**Pressure Vessel Directive 2009/105/EC.**  
**EMC Directive 2004/108/EC**  
**Low Voltage Directive 2006/95/EC**  
**RoHS Directive 2011/65/EU**  
**Noise Emission Directive 2005/88/EC**  
 dichiara sotto la propria esclusiva responsabilità che: Modelli:  
**PC 1010 EU, PC 1010EU-2P, PC 1010EUS, PC 1010EUS-UK110,**  
**PC 1010PL, PC 1010S, PC 1010UK1, PC 1010UK2**  
 è conforme ai requisiti essenziali di salute e sicurezza previsti dai seguenti documenti:  
**EN ISO 14121-1:2007, EN ISO 3744:1995, EN ISO 4871:2009,**  
**EN1012-1:2010, EN 60204-1:2006+A1:2009, EN286-1:1998**  
 Firmato: Chris Klein  
 Posizione: Responsabile di progettazione  
 Luogo di emissione: Senco Brands, Inc.  
 4270 Ivy Pointe Blvd., Cincinnati, Ohio 45245  
 Edizione originale: 4 Settembre 2014  
 Rappresentante autorizzato:  
 (autorizzato alla compilazione del rapporto tecnico)  
 Nome: Peter van der Wel  
 Indirizzo: Senco Brands B.V.  
 Geurdeland 17E, 6673 DR Andelst, The Netherlands

**1. Senco Professional End User Warranty Policy**

Considering the following constraints Senco underwrites the reliability and the quality of its supplied authorised Senco branded products.

1.1 Senco warrants to the end user that the following products will be free from defects in construction, assembly and material for the warranty period specified below.

Product	Warranty period
Senco ® XP Series-Red Cap, pneumatic tools	Five years
Senco ® XP Series-Black Cap, pneumatic tools	Two years
Senco Pro Series, pneumatic tools	One year
Senco Semi-Pro Series, pneumatic tools	One year
Senco DuraSpin ® Series, electric and battery tools	One year
Senco Cordless battery tools	Two years
Senco batteries and chargers for tools	One year
Senco gas tools	Two years
Senco Reconditioned Products	One year
Senco other tools	One year
Senco Compressors	One year

1.2 The warranty period starts on the day the end user purchases the product and/or 1 year after the tool has been deleted from the product line, whichever date comes first.

1.3 To claim warranty the end user needs to send the defective products or their parts, including the serial number and the original and dated sales receipt or proof of purchase from the original retailer or dealer, freight prepaid to the original retailer or dealer.

1.4 Senco is not obliged to do any repairs or replacements on any products or their parts on site.

1.5 During the warranty period Senco or its distributors will repair or replace defective products or their parts, exclusively or mainly as a result of an imperfection in construction, assembly or material, at Senco's option and expense, subject to the constraints of this warranty policy.

1.6 The repair or replacement of products or their parts under warranty, does in no case lead to prolongation of the warranty period. For every replacement product or part, the remaining original warranty period of the replaced product or part is applicable.

1.7 Senco will become the owner of the products or parts that have been replaced by Senco or its distributors as a result of being compliant to Senco's warranty, without being obligated any compensation in this matter.

1.8 Excluded from the warranty are:

- Normal wear and tear parts, for example rubber o-rings, seals, driver blades, piston stops, piston/driver assemblies, isolators, drive belts, air filters and fuel systems, bits;
- Any imperfection that is a result of or has evolved from the fact that there has not been used clean, dry regulated compressed air and/or the air pressure applied has exceeded the maximum indicated on the tool casting (pneumatic tools);
- Any imperfection that is a result of or has evolved from normal wear, misapplication, abuse/misuse, improper modifications or storage, shipping/transport, accidents, neglect, operation at other than recommended speeds or voltage (electric units only);
- Any imperfection that is a result of or has evolved from explosions, fires and natural disasters, like hurricanes, floods and earthquakes;
- Any imperfection that is a result of or has evolved from not following operating instructions, specifications and / or maintenance schedules. Read the Operator Manual for use, specifications and maintenance instructions;
- Any imperfection that is caused by repairs, modifications to the product or attempts to do so by the end user or any third party;
- Labour charges or loss or damage resulting from improper operation, maintenance or repairs are not covered by this warranty
- Any warranty claims that have been received after the warranty period, as specified in this end user warranty, has expired.

1.9 Additional costs like shipping/transport, special packaging requirements and costs of travel and accommodation, are at the end users expense.

1.10 If a complaint is unfounded, all costs incurred thereby, including handling, inspection, shipping and administrative costs on the side of Senco or its distributors, will be charged to the end user.

1.11 After expiration of the warranty period, all costs for repair or replacement, including handling, inspection, shipping and administrative costs will be charged to the end user.

1.12 Notwithstanding legal limitation periods, the limitation of all claims and appeals against Senco and third parties involved by Senco for the implementation of the agreement is one year.

1.13 If Senco fails to meet this agreement, it will not discharge the end user from the obligations arising under this or any other contract.

1.14 When the warranty terms can not be met, due to for example import or export prohibitions, strikes or other unforeseen circumstances, the warranty period will be extended accordingly.

1.15 Senco's liability is limited to the warranty. Senco is not liable for damage caused by the functioning or non-functioning of the products as delivered, repaired or modified by Senco or its distributors, including but not limited to, production losses, profit losses, reduced working range, commercial losses or consequential damages or indirect damages whatsoever.

## Compressore D'aria Elettrico

### Parts Reference Guide

NO:RLB-1409

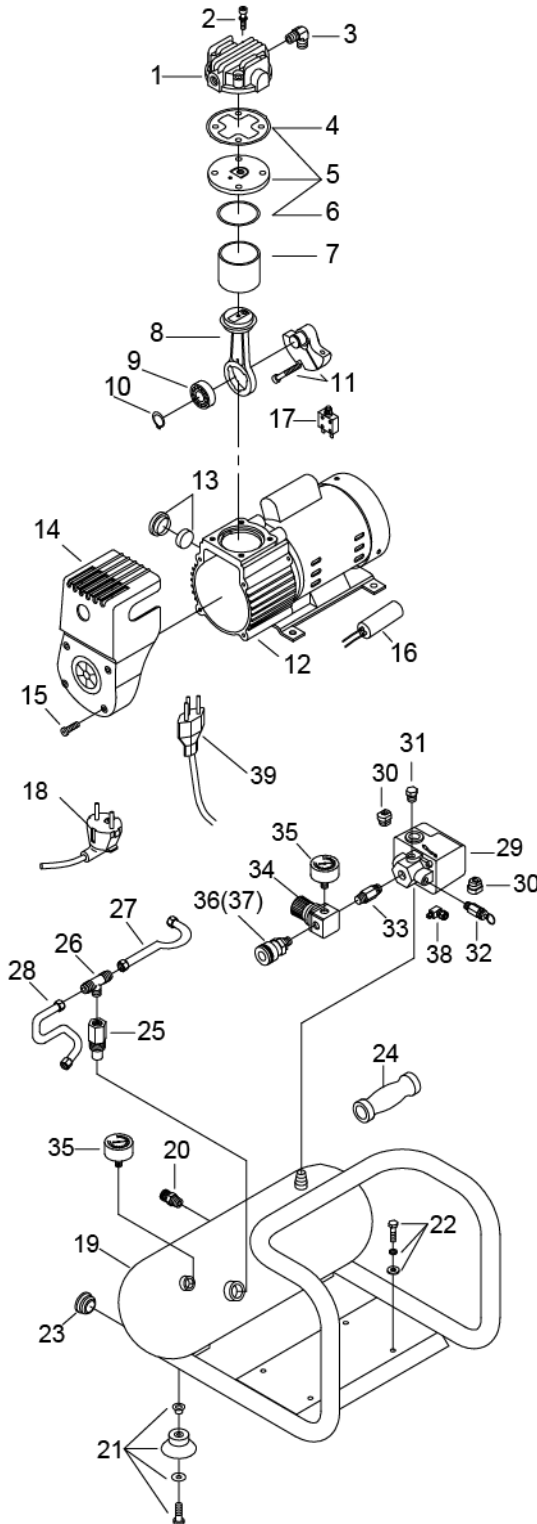

Ref. No.	Description	Part No.	Qty.
1	CYLINDER HEAD	3101063A	1
2	ALLEN BOLT SET	3B01-M05*060V	4
3	EXHAUST ELBOW	2N06-01T02H	1
4	CYLINDER HEAD GASKET	2G01-025H	1
5	EXHAUST VALVE ASSEMBLY	3B11-DC02A	1
6	VALVE SEAT GASKET	2G03-018	1
7	CYLINDER	3201068	1
8	ROD ASSEMBLY	3B3-MB02	1
9	BEARING	2N35-6201ZZC3	1
10	CLIP	2N42-S12	1
11	CRANKSHAFT & BALANCER	3304086	1
12	MOTOR SET	3B8-MB0206S	1
13	AIR FILTER SET	2140026RS	1
14	SHROUD	2428015RS	1
15	BOLT	2B02-FM4*015B	4
16	RUNNING CAPACITOR	2E27-004F4525	1
17	CIRCUIT BREAKER	2E25-01AS	1
18	POWER CABLE (2 PIN)	2E01-029S	1
19	AIR TANK	3401174U	1
20	DRAIN VALVE	2405012	1
21	RUBBER PAD SET	3433011-ARS	4
22	HEXAGON BOLT SET	3B00-FM06*012RS	4
23	PLUG	2N32-W07RS	2
24	GRIP	2432107	1
25	CHECK VALVE	2414033A	1
26	UNLOADING 3-WAY PIPE	2N09-02H01T02H4	1
27	UNLOADING TUBE	3B2-02*190F	1
28	DISCHARGE TUBE	2T02-02*0260RS	1
29	PRESSURE SWITCH	2E21-AA256BPS	1
30	STRAIN RELIEF BUSHING	2E04-008	2
31	PLUG	2N33-009	1
32	PRESSURE RELIEF VALVE	2406021A	1
33	NIPPLE	2N01-058RS	1
34	REGULATOR	2408008RRS	1
35	PRESSURE GAUGE	2D12-15D14BAR	2
36	QUICK COUPLER (FOR PC1010EU ONLY)	07S1/4M-ERS	1
37	QUICK COUPLER (FOR PC1010EU COMBO KIT, PC1010S, 6PR2001N)	07OS1/4M-C	1
38	UNLOADING VALVE	2409015	1
39	POWER CABLE (3 PIN)	2E01-044S	1